

Features

- Epitaxial Planar Die Construction
- Complementary PNP Types Available (DDTA)
- Built-In Biasing Resistor, R2 only

Mechanical Data

- Case: SOT-23, Molded Plastic
- Case material - UL Flammability Rating 94V-0
- Moisture sensitivity: Level 1 per J-STD-020A
- Terminals: Solderable per MIL-STD-202, Method 208
- Terminal Connections: See Diagram
- Marking: Date Code and Marking Code (See Diagrams & Page 2)
- Weight: 0.008 grams (approx.)
- Ordering Information (See Page 2)

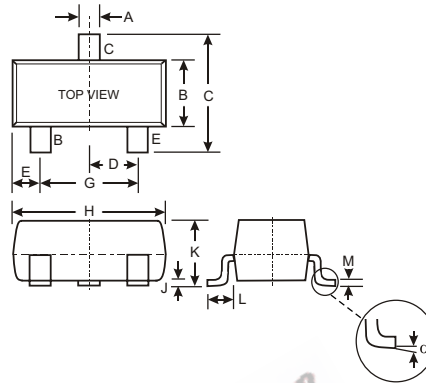

| SOT-23 | | |
|----------------------|-------|------|
| Dim | Min | Max |
| A | 0.37 | 0.51 |
| B | 1.20 | 1.40 |
| C | 2.30 | 2.50 |
| D | 0.89 | 1.03 |
| E | 0.45 | 0.60 |
| G | 1.78 | 2.05 |
| H | 2.80 | 3.00 |
| J | 0.013 | 0.10 |
| K | 0.903 | 1.10 |
| L | 0.45 | 0.61 |
| M | 0.85 | 0.80 |
| α | 0° | 8° |
| All Dimensions in mm | | |

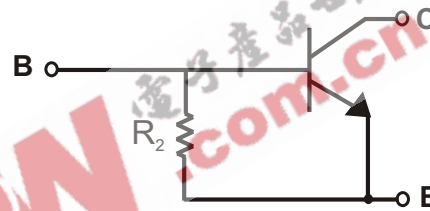

SCHEMATIC DIAGRAM

| P/N | R2 (NOM) | MARKING |
|------------|----------|---------|
| DDTC114GCA | 10KΩ | N26 |
| DDTC124GCA | 22KΩ | N27 |
| DDTC144GCA | 47KΩ | N28 |
| DDTC115GCA | 100KΩ | N29 |

Maximum Ratings @ T_A = 25°C unless otherwise specified

| Characteristic | Symbol | Value | Unit |
|--|-----------------------------------|-------------|------|
| Collector-Base Voltage | V _{CBO} | 50 | V |
| Collector-Emitter Voltage | V _{CEO} | 50 | V |
| Emitter-Base Voltage | V _{EBO} | 5 | V |
| Collector Current | I _C (Max) | 100 | mA |
| Power Dissipation | P _d | 200 | mW |
| Thermal Resistance, Junction to Ambient Air (Note 1) | R _{θJA} | 625 | °C/W |
| Operating and Storage and Temperature Range | T _J , T _{STG} | -55 to +150 | °C |

Note: 1. Mounted on FR4 PC Board with recommended pad layout at <http://www.diodes.com/datasheets/ap02001.pdf>.

Electrical Characteristics @ $T_A = 25^\circ\text{C}$ unless otherwise specified

| Characteristic | | Symbol | Min | Typ | Max | Unit | Test Condition |
|--------------------------------------|------------|---------------|-----|-----|-----|---------------|---|
| Collector-Base Breakdown Voltage | | BV_{CBO} | 50 | — | — | V | $I_C = 50\mu\text{A}$ |
| Collector-Emitter Breakdown Voltage | | BV_{CEO} | 50 | — | — | V | $I_C = 1\text{mA}$ |
| Emitter-Base Breakdown Voltage | | BV_{EBO} | 5 | — | — | V | $I_E = 720\mu\text{A}$, DDTC114GCA $I_E = 330\mu\text{A}$, DDTC124GCA $I_E = 160\mu\text{A}$, DDTC144GCA $I_E = 72\mu\text{A}$, DDTC115GCA |
| Collector Cutoff Current | | I_{CBO} | — | — | 0.5 | μA | $V_{CB} = 50\text{V}$ |
| Emitter Cutoff Current | DDTC114GCA | I_{EBO} | 300 | — | 580 | μA | $V_{EB} = 4\text{V}$ |
| | DDTC124GCA | | 140 | | 260 | | |
| | DDTC144GCA | | 65 | | 130 | | |
| | DDTC115GCA | | 30 | | 58 | | |
| Collector-Emitter Saturation Voltage | | $V_{CE(sat)}$ | — | — | 0.3 | V | $I_C = 10\text{mA}$, $I_B = 0.5\text{mA}$ |
| DC Current Transfer Ratio | DDTC114GCA | h_{FE} | 30 | — | — | — | $I_C = 5\text{mA}$, $V_{CE} = 5\text{V}$ |
| | DDTC124GCA | | 56 | | | | |
| | DDTC144GCA | | 68 | | | | |
| | DDTC115GCA | | 82 | | | | |
| Bleeder Resistor (R_2) Tolerance | | DR_2 | -30 | — | +30 | % | — |
| Gain-Bandwidth Product* | | f_T | — | 250 | — | MHz | $V_{CE} = 10\text{V}$, $I_E = -5\text{mA}$, $f = 100\text{MHz}$ |

* Transistor - For Reference Only

Ordering Information (Note 2)

| Device | Packaging | Shipping |
|--------------|-----------|------------------|
| DDTC114GCA-7 | SOT-23 | 3000/Tape & Reel |
| DDTC124GCA-7 | SOT-23 | 3000/Tape & Reel |
| DDTC144GCA-7 | SOT-23 | 3000/Tape & Reel |
| DDTC115GCA-7 | SOT-23 | 3000/Tape & Reel |

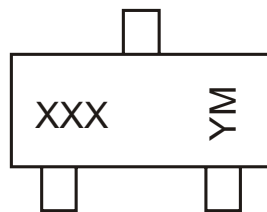
Notes: 2. For Packaging Details, go to our website at <http://www.diodes.com/datasheets/ap02007.pdf>.**Marking Information**

XXX = Product Type Marking Code
See Sheet 1 Diagrams
YM = Date Code Marking
Y = Year ex: N = 2002
M = Month ex: 9 = September

Date Code Key

| Year | 2002 | 2003 | 2004 | 2005 | 2006 | 2007 | 2008 | 2009 |
|------|------|------|------|------|------|------|------|------|
| Code | N | P | R | S | T | U | V | W |

| Month | Jan | Feb | March | Apr | May | Jun | Jul | Aug | Sep | Oct | Nov | Dec |
|-------|-----|-----|-------|-----|-----|-----|-----|-----|-----|-----|-----|-----|
| Code | 1 | 2 | 3 | 4 | 5 | 6 | 7 | 8 | 9 | O | N | D |

TYPICAL CURVES - DDTC114GCA

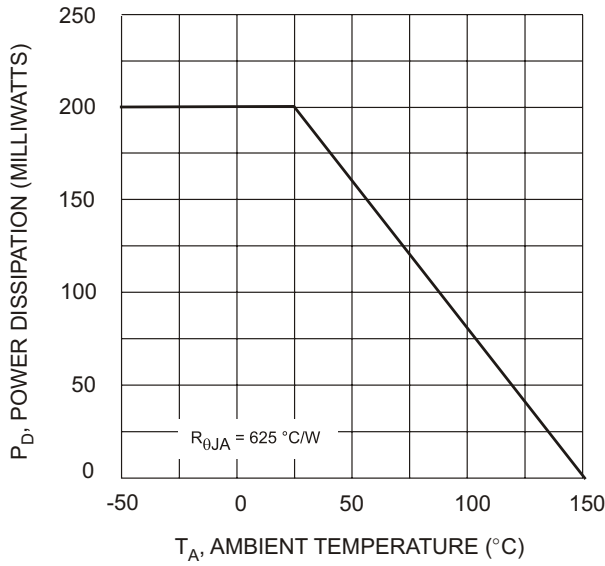

Fig. 1 Derating Curve

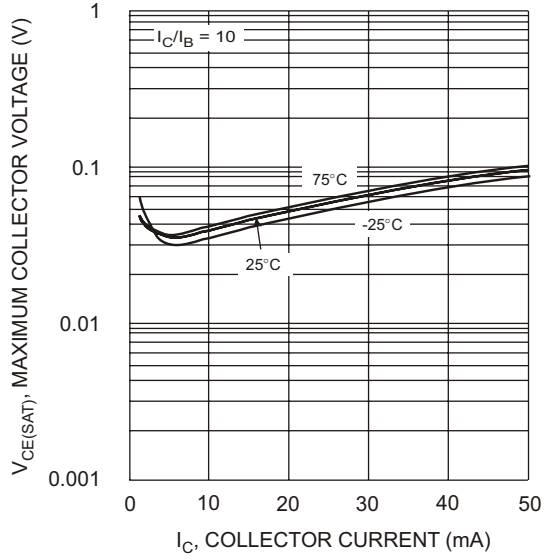

Fig. 2 $V_{CE(SAT)}$ vs. I_C

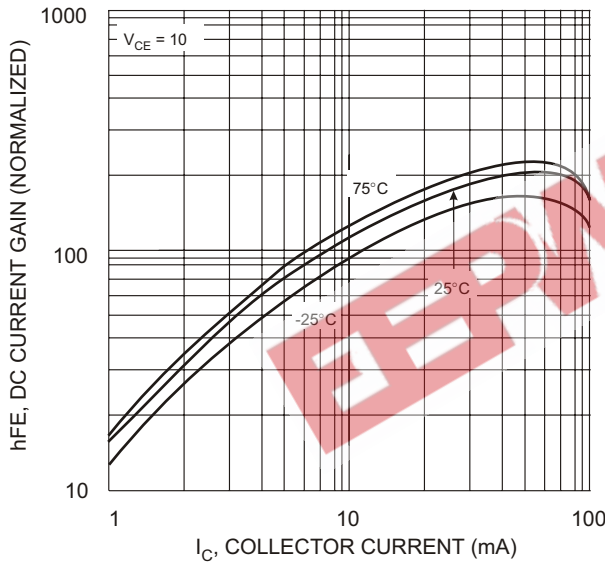

Fig. 3 DC CURRENT GAIN

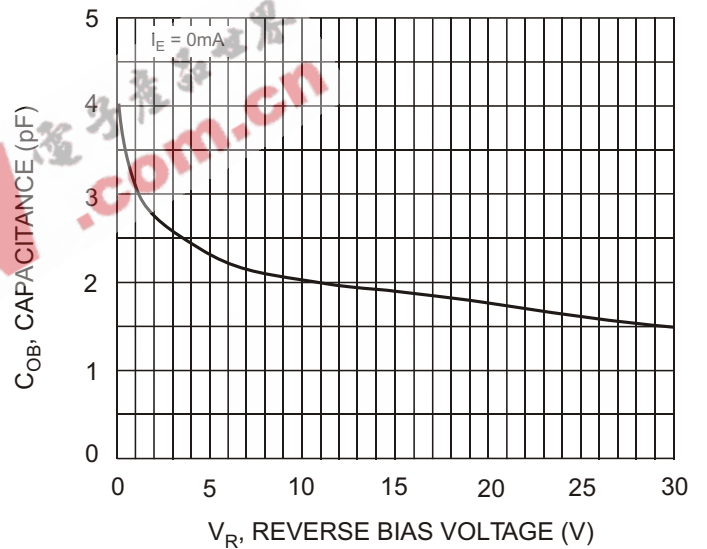

Fig. 4 Output Capacitance

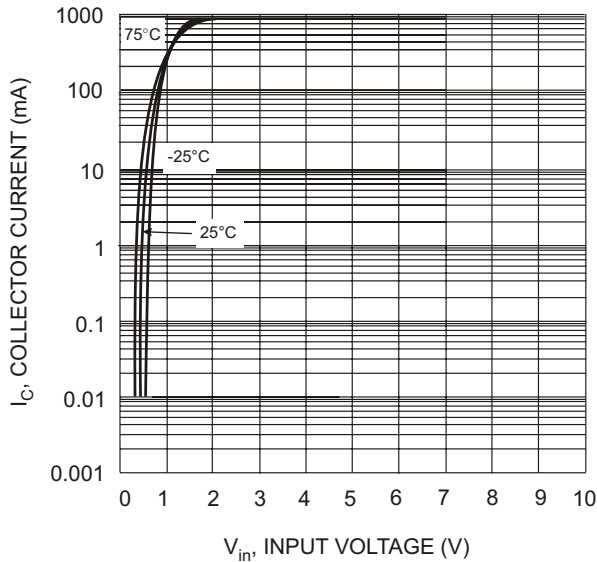

Fig. 5 Collector Current Vs. Input Voltage

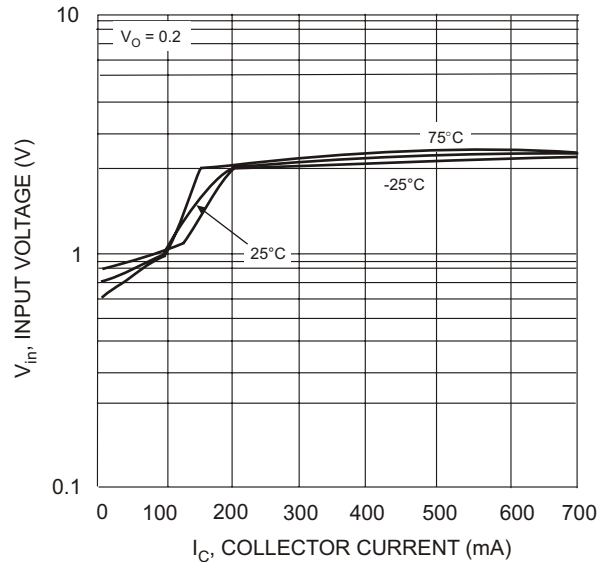

Fig. 6 Input Voltage vs. Collector Current