



16-Bit, Single-Channel, $\pm 18V$ Output (Unbuffered), Ultra-Low Power, Serial Interface DIGITAL-TO-ANALOG CONVERTER

FEATURES

- 16-Bit Resolution
- Output: $\pm 18V$ for $\pm 18V$ Reference Input
- $\pm 18V$ Supply Operation
- Very Low Power
- High Accuracy INL: 1LSB
- Low Noise: $10nV/\sqrt{Hz}$
- Fast Settling: $1\mu s$ to 1LSB
- Fast SPI™ Interface: Up To 50MHz
- 16-Pin TSSOP Package
- Selectable Reset to Zero or Midscale

APPLICATIONS

- Portable Equipment
- Automatic Test Equipment
- Industrial Process Control
- Data Acquisition Systems
- Optical Networking

DESCRIPTION

The DAC8871 is a 16-bit, single-channel, serial input, voltage output digital-to-analog converter (DAC). The output range is determined by the reference voltage, V_{REFH} and V_{REFL} . By properly selecting the reference, the output can be unipolar or bipolar, and up to $\pm 18V$. These converters provide excellent linearity (1LSB INL), low noise, and fast settling ($1\mu s$ to 1LSB of full scale output) over the specified temperature range of $-40^{\circ}C$ to $+105^{\circ}C$. The output is unbuffered, which reduces the power consumption and the error introduced by the buffer. The device features a standard high-speed clock (up to 50MHz), and a 3V or 5V SPI serial interface to communicate with the DSP or microprocessors.

For optimum performance, a set of Kelvin connections to external reference are provided. The DAC8871 is available in a TSSOP-16 package.

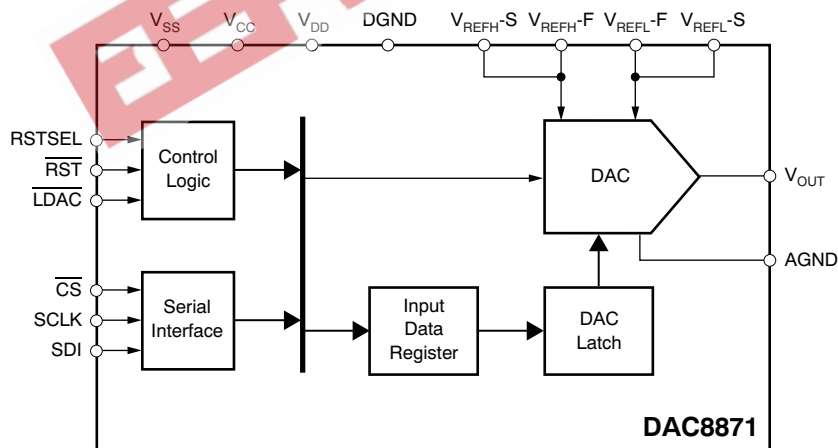

Please be aware that an important notice concerning availability, standard warranty, and use in critical applications of Texas Instruments semiconductor products and disclaimers thereto appears at the end of this data sheet.

TI DSP is a trademark of Texas Instruments.

SPI, QSPI are trademarks of Motorola, Inc.

Microwire is a trademark of National Semiconductor.

All other trademarks are the property of their respective owners.



This integrated circuit can be damaged by ESD. Texas Instruments recommends that all integrated circuits be handled with appropriate precautions. Failure to observe proper handling and installation procedures can cause damage.

ESD damage can range from subtle performance degradation to complete device failure. Precision integrated circuits may be more susceptible to damage because very small parametric changes could cause the device not to meet its published specifications.

ORDERING INFORMATION⁽¹⁾

PRODUCT	MINIMUM RELATIVE ACCURACY (LSB)	DIFFERENTIAL NONLINEARITY (LSB)	SPECIFIED TEMPERATURE RANGE	PACKAGE MARKING	PACKAGE-LEAD	PACKAGE DESIGNATOR
DAC8871B	±1	±1	–40°C to +105°C	8871	TSSOP-16	PW
DAC8871	±3	±1	–40°C to +105°C	8871	TSSOP-16	PW

(1) For the most current package and ordering information, see the Package Option Addendum at the end of this data sheet, or see the TI website at www.ti.com.

ABSOLUTE MAXIMUM RATINGS⁽¹⁾

over operating free-air temperature range (unless otherwise noted).

	DAC8871	UNIT
V _{DD} to GND	–0.3 to +7	V
Digital input voltage to GND	–0.3 to (V _{DD} + 0.3)	V
AGND to DGND	–0.3 to +0.3	V
V _{CC} to V _{SS}	–0.3 to +39.6	V
V _{CC} to AGND	–0.3 to +19.8	V
V _{SS} to AGND	+0.3 to –19.8	V
V _{REFH} to V _{REFL}	–0.3 to +39.6	V
V _{REFH} to AGND	–0.3 to +19.8	V
V _{REFL} to AGND	–19.8 to +17.5	V
Operating temperature range	–40 to +105	°C
Storage temperature range	–65 to +150	°C
Maximum junction temperature (T _J max)	+150	°C
Power dissipation	(T _J max – T _A)/θ _{JA}	W
Thermal impedance, θ _{JA}	TSSOP-16 161.4	°C/W

(1) Stresses above those listed under absolute maximum ratings may cause permanent damage to the device. Exposure to absolute maximum conditions for extended periods may affect device reliability.

ELECTRICAL CHARACTERISTICS

All specifications at $T_A = T_{MIN}$ to T_{MAX} , $V_{CC} = +15V$, $V_{SS} = -15V$, $V_{REFH} = +10V$, $V_{REFL} = -10V$, and $V_{DD} = +5V$, unless otherwise noted; specifications subject to change without notice.

PARAMETER		CONDITIONS	DAC8871			UNIT
			MIN	TYP	MAX	
STATIC PERFORMANCE						
Resolution			16			Bits
Linearity error	DAC8871B	$V_{REFH} = 10V, V_{REFL} = -5V$		± 0.75	± 1	LSB
		$V_{REFH} = 10V, V_{REFL} = -10V$		± 1	± 1.5	LSB
	DAC8871			± 1	± 3	LSB
Differential linearity error				± 0.25	± 1	LSB
Gain error		$T_A = +25^\circ C$		± 0.5	± 2	LSB
Gain drift				± 0.1		ppm/ $^\circ C$
Bipolar zero error		$T_A = +25^\circ C$		± 1	± 4	LSB
Bipolar drift				± 0.1		ppm/ $^\circ C$
Zero code error		$T_A = +25^\circ C$		± 0.5	± 2	LSB
Zero code drift				± 0.05		ppm/ $^\circ C$
OUTPUT CHARACTERISTICS						
Voltage output			V_{REFL}		V_{REFH}	V
Output impedance				6.25		k Ω
Settling time		To 1LSB of FS, $C_L = 15$ pF		1		μs
Slew rate ⁽¹⁾		$C_L = 15$ pF		40		V/ μs
Digital feedthrough ⁽²⁾				0.2		nV-s
Output noise		$T_A = +25^\circ C$		10		nV/ \sqrt{Hz}
Power supply rejection		Supplies vary $\pm 10\%$			± 1	LSB
REFERENCE INPUT						
V_{REFH}	Ref high input voltage range		0		+18	V
V_{REFL}	Ref low input voltage range		-18		$V_{REFH} - 1.25$	V
	Ref high input current			1.3		mA
	Ref low input current			-1.3		mA
	Reference input impedance ⁽³⁾		7.5			k Ω
	Reference input capacitance	Code = 0000h		75		pF
		Code = FFFFh		120		pF
DIGITAL INPUTS						
V_{IL}	Input low voltage	$V_{DD} = +5V$	DGND		0.8	V
		$V_{DD} = +3V$	DGND		0.6	V
V_{IH}	Input high voltage	$V_{DD} = +5V$		2.6	V_{DD}	V
		$V_{DD} = +3V$		2.1	V_{DD}	V
	Input current				± 1	μA
	Input capacitance				10	pF

(1) Slew Rate is measure from 10% to 90% of transition when the output changes from 0 to full scale.

(2) Digital feedthrough is defined as the impulse injected into the analog output from the digital input. It is measured when the DAC output does not change; \overline{CS} is held high, while SCLK and DIN signals are toggled. It is specified with a full-scale code change on the SDI bus (that is, from all 0s to all 1s and vice versa).

(3) Reference input resistance is code-dependent, with a minimum at 8555h

ELECTRICAL CHARACTERISTICS (continued)

All specifications at $T_A = T_{MIN}$ to T_{MAX} , $V_{CC} = +15V$, $V_{SS} = -15V$, $V_{REFH} = +10V$, $V_{REFL} = -10V$, and $V_{DD} = +5V$, unless otherwise noted; specifications subject to change without notice.

PARAMETER	CONDITIONS	DAC8871			UNIT
		MIN	TYP	MAX	
POWER SUPPLY					
V_{CC}		+13.5	+15	+19.8	V
V_{SS}		-19.8	-15	-13.5	V
V_{DD}		+2.7		+5.5	V
I_{CC}			0.01	2	μA
I_{SS}			-0.01	-2	μA
I_{DD}			3	10	μA
Power			15	30	μW
TEMPERATURE RANGE					
Specified performance		-40		+105	$^{\circ}C$

EEPW.com.cn 电子产品世界

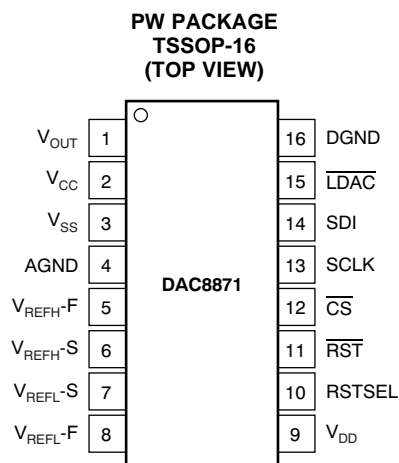
PIN CONFIGURATION (NOT TO SCALE)**TERMINAL FUNCTIONS**

TERMINAL		DESCRIPTION
NO.	NAME	
1	V _{OUT}	Analog output of the DAC
2	V _{CC}	Positive analog power supply: +15V
3	V _{SS}	Negative analog power supply: -15V
4	AGND	Analog ground
5	V _{REFH-F}	V _{REFH} reference input (Force). Connect to external V _{REFH} .
6	V _{REFH-S}	V _{REFH} reference input (Sense). Connect to external V _{REFH} .
7	V _{REFL-S}	V _{REFL} reference input (Sense). Connect to external V _{REFL} .
8	V _{REFL-F}	V _{REFL} reference input (Force). Connect to external V _{REFL} .
9	V _{DD}	Digital power. +5V for 5V interface logic; +3V for 3V logic.
10	RSTSEL	Power-On-Reset select. Determines V _{OUT} after power-on reset. If tied to V _{DD} , the DAC latch is set to mid-scale after power-on, and V _{OUT} is (V _{REFH} - V _{REFL})/2. If tied to DGND, the DAC latch is cleared ('0'), and V _{OUT} is V _{REFL} .
11	RST	Reset (active low)
12	CS	Chip select input (active low). Data are not clocked into SDI unless CS is low.
13	SCLK	Serial clock input
14	SDI	Serial data input. Data are latched into input register on the rising edge of SCLK.
15	LDAC	Load DAC control input (active low). When LDAC is low, the DAC latch is simultaneously updated with the content of the input register.
16	DGND	Digital ground

TIMING DIAGRAMS

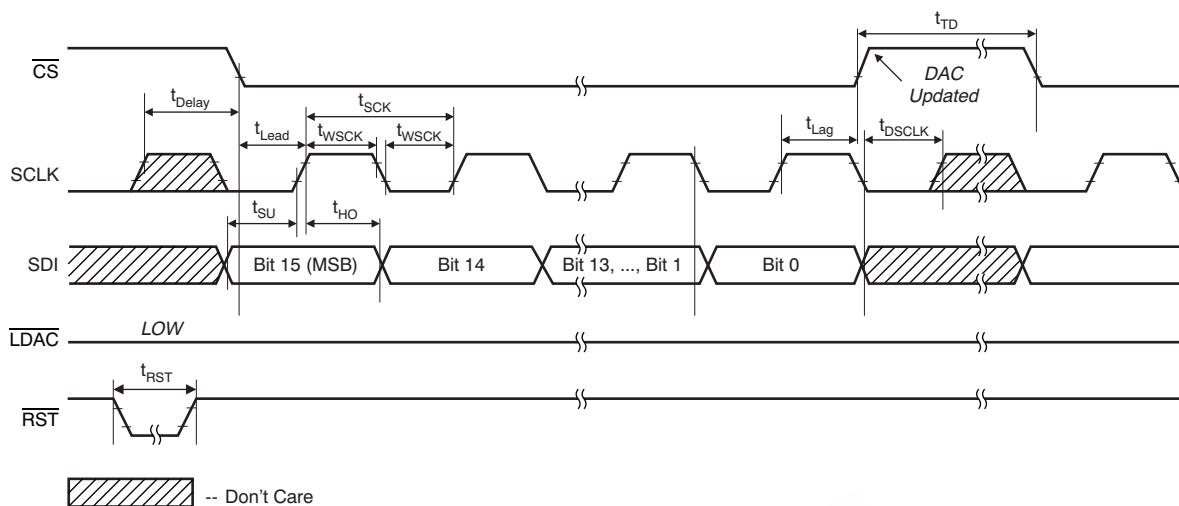

Figure 1. Case 1—LDAC Tied Low

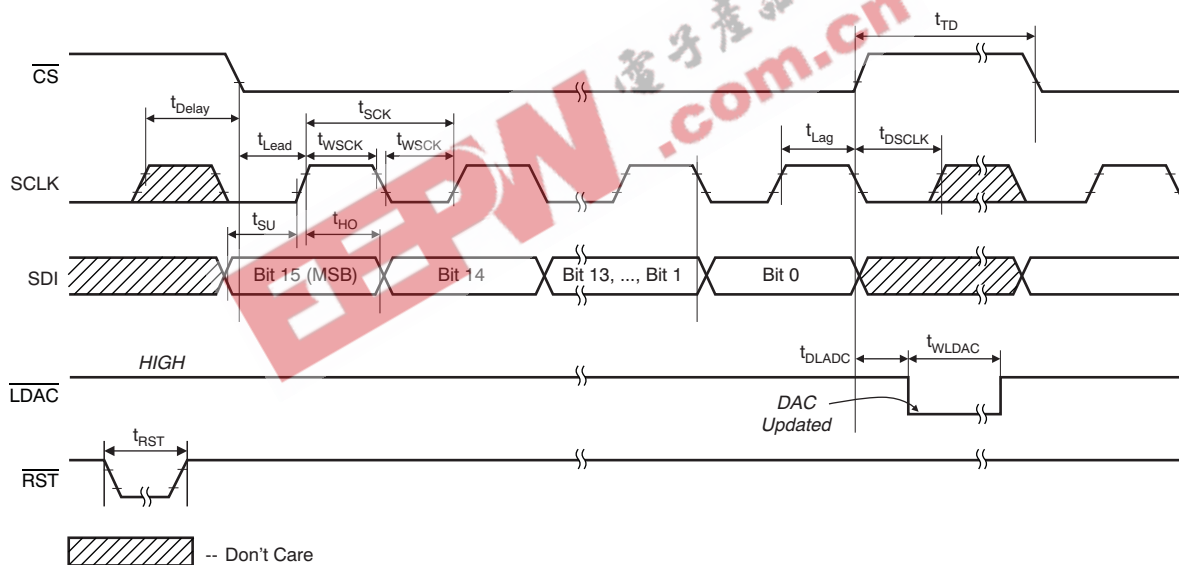

Figure 2. Case 2—LDAC Active

TIMING CHARACTERISTICS: $V_{DD} = +5V^{(1)(2)}$ At $-40^{\circ}C$ to $+105^{\circ}C$, unless otherwise noted.

PARAMETER		MIN	MAX	UNIT
t_{SCK}	SCLK period	20		ns
t_{WSCK}	SCLK high or low time	10		ns
t_{Delay}	Delay from SCLK high to \overline{CS} low	10		ns
t_{Lead}	\overline{CS} enable lead time	10		ns
t_{Lag}	\overline{CS} enable lag time	10		ns
t_{DSCLK}	Delay from \overline{CS} high to SCLK high	10		ns
t_{TD}	\overline{CS} high between active period	30		ns
t_{SU}	Data setup time (input)	10		ns
t_{HO}	Data hold time (input)	0		ns
t_{WLDAC}	\overline{LDAC} width	30		ns
t_{DLDAC}	Delay from \overline{CS} high to \overline{LDAC} low	30		ns
t_{RST}	Reset (RST) low	10		ns
	V_{DD} high to \overline{CS} low (power-up delay)	10		μs

(1) Assured by design. Not production tested.

(2) Sample tested during the initial release and after any redesign or process changes that may affect this parameter.



 电子产业世界
 .com.cn

TYPICAL CHARACTERISTICS

At $T_A = +25^\circ\text{C}$, $V_{DD} = +5\text{V}$, $V_{CC} = +15\text{V}$, $V_{SS} = -15\text{V}$, $V_{REFH} = +10\text{V}$, and $V_{REFL} = -10\text{V}$, unless otherwise noted.

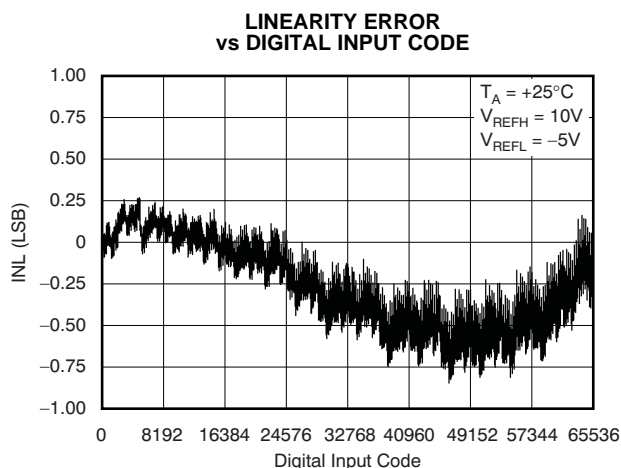

Figure 3.

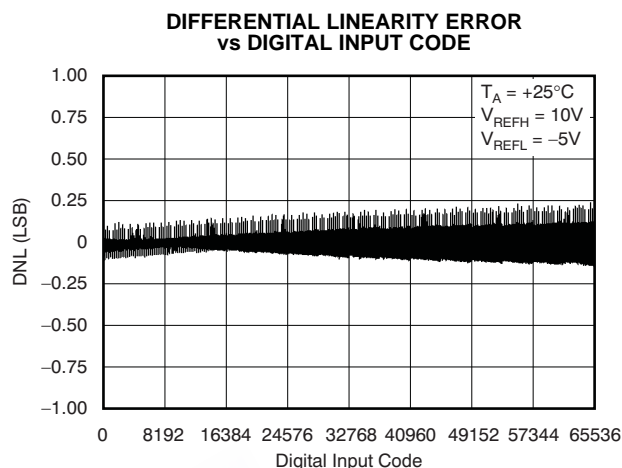

Figure 4.

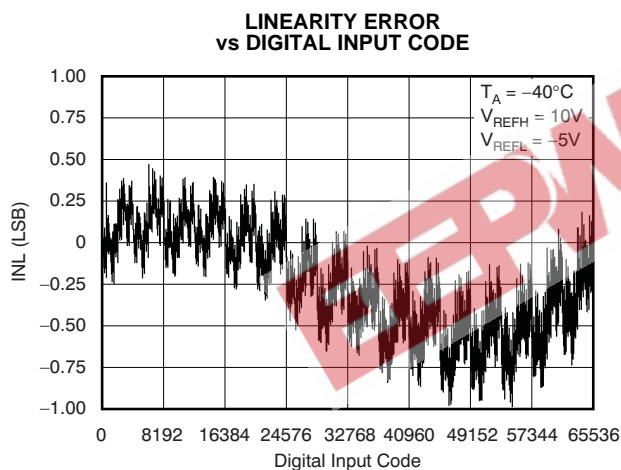

Figure 5.

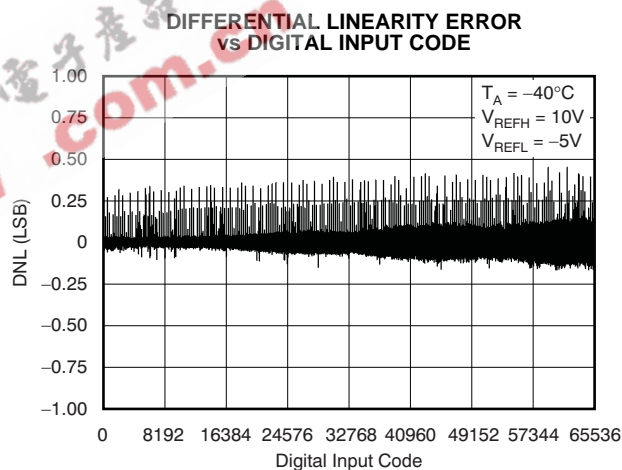

Figure 6.

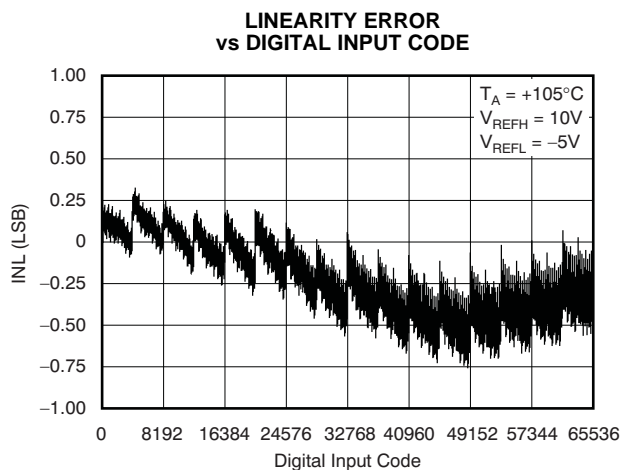

Figure 7.

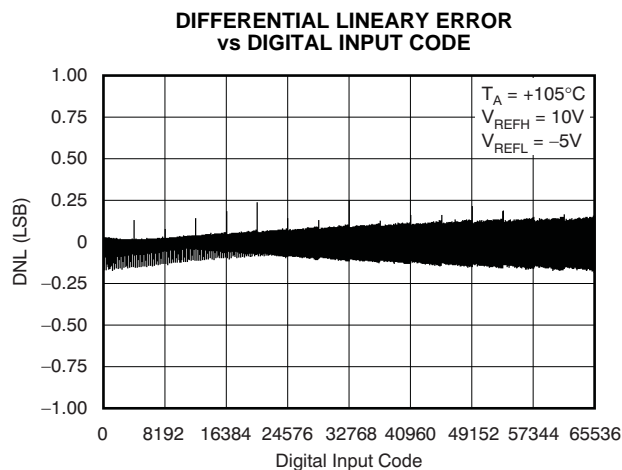

Figure 8.

TYPICAL CHARACTERISTICS (continued)

At $T_A = +25^\circ\text{C}$, $V_{DD} = +5\text{V}$, $V_{CC} = +15\text{V}$, $V_{SS} = -15\text{V}$, $V_{REFH} = +10\text{V}$, and $V_{REFL} = -10\text{V}$, unless otherwise noted.

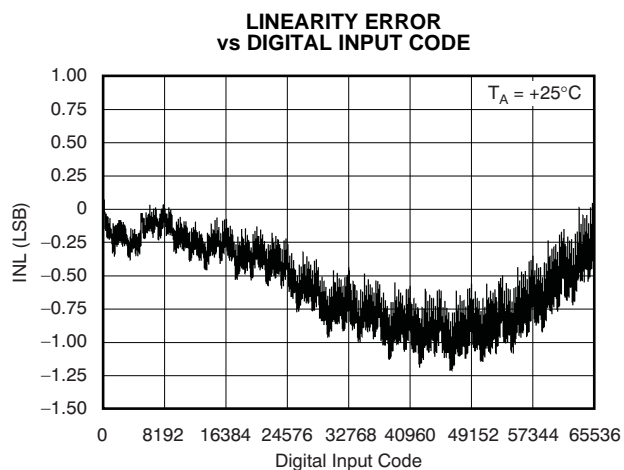

Figure 9.

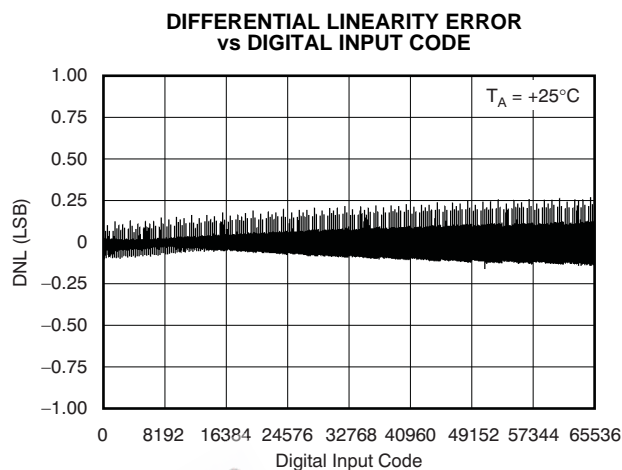

Figure 10.

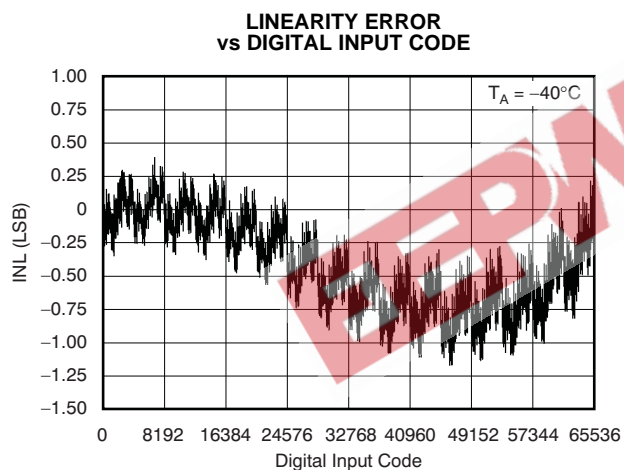

Figure 11.

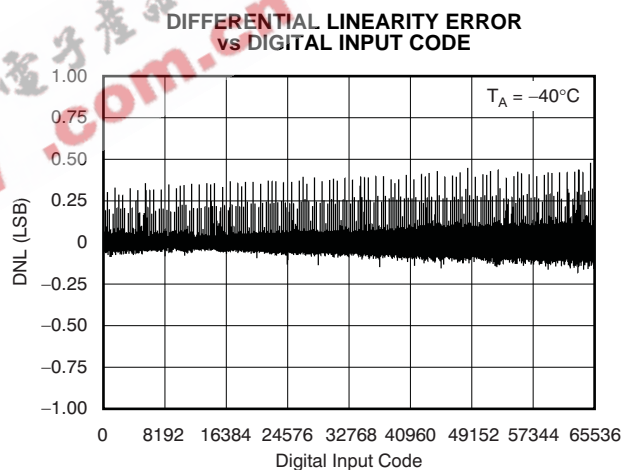

Figure 12.

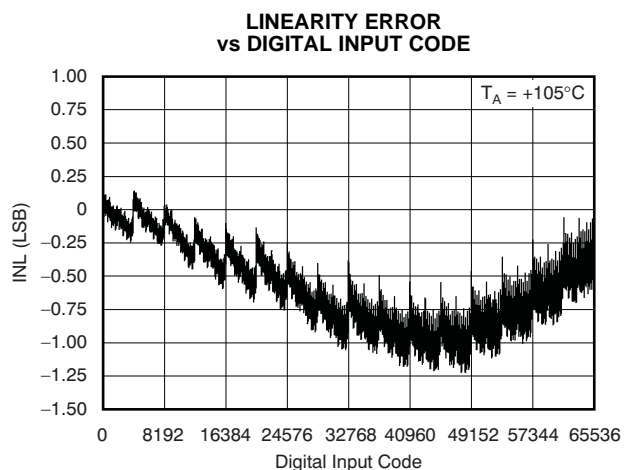

Figure 13.

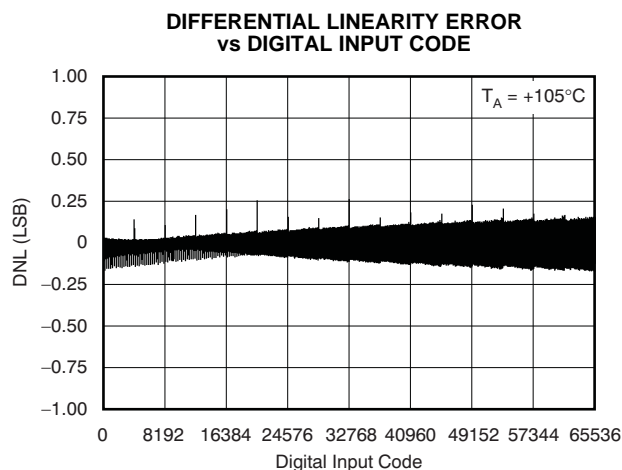

Figure 14.

TYPICAL CHARACTERISTICS (continued)

At $T_A = +25^\circ\text{C}$, $V_{DD} = +5\text{V}$, $V_{CC} = +15\text{V}$, $V_{SS} = -15\text{V}$, $V_{REFH} = +10\text{V}$, and $V_{REFL} = -10\text{V}$, unless otherwise noted.

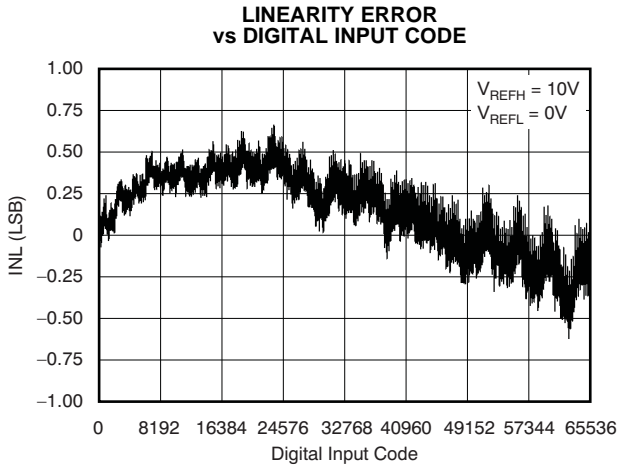

Figure 15.

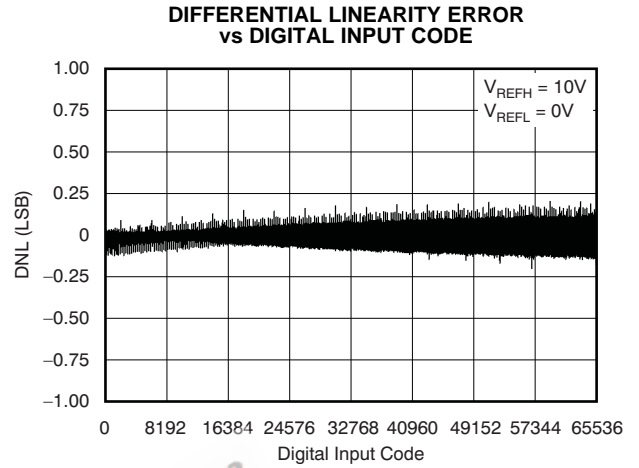

Figure 16.

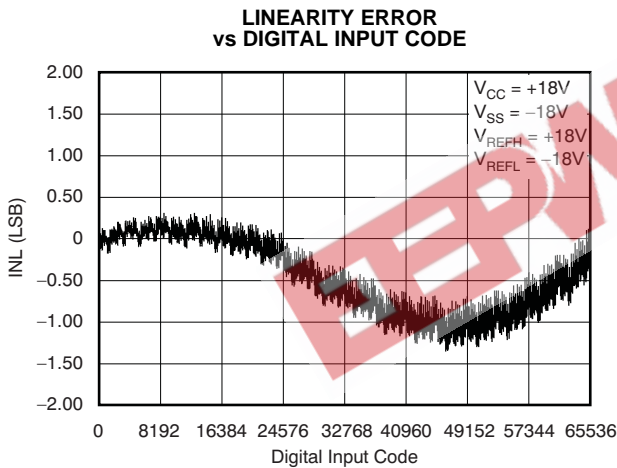

Figure 17.

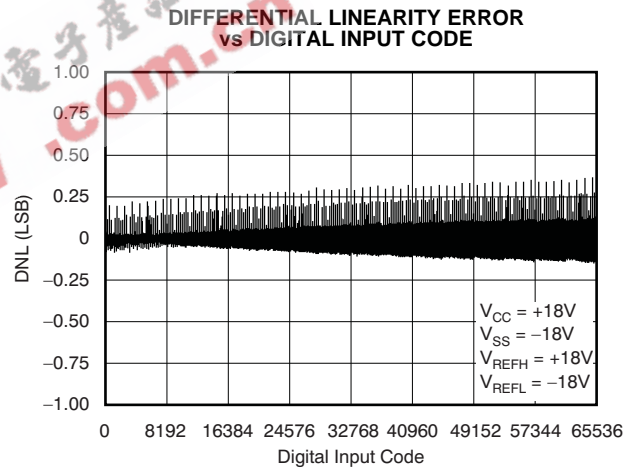

Figure 18.

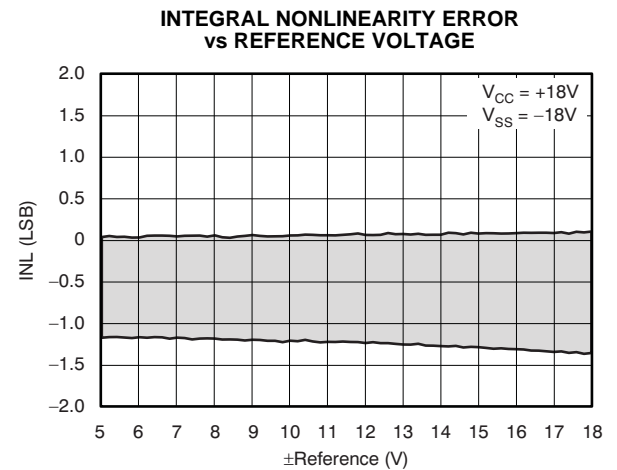

Figure 19.

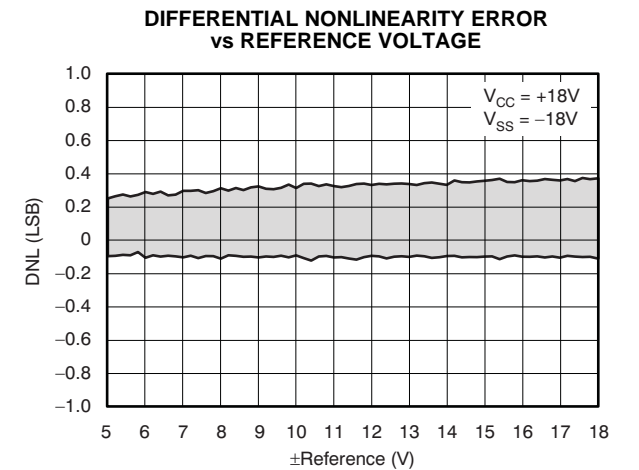

Figure 20.

TYPICAL CHARACTERISTICS (continued)

At $T_A = +25^\circ\text{C}$, $V_{DD} = +5\text{V}$, $V_{CC} = +15\text{V}$, $V_{SS} = -15\text{V}$, $V_{REFH} = +10\text{V}$, and $V_{REFL} = -10\text{V}$, unless otherwise noted.

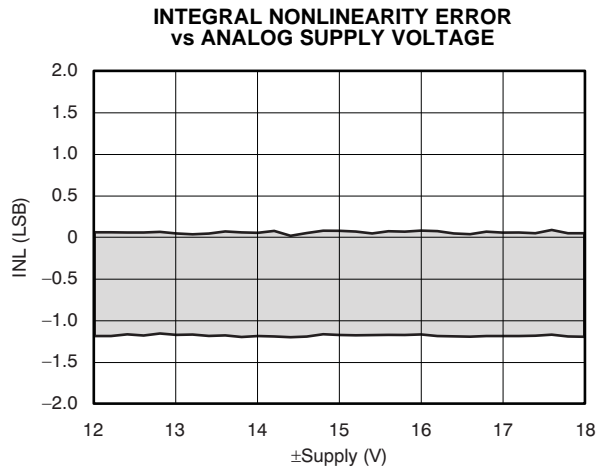

Figure 21.

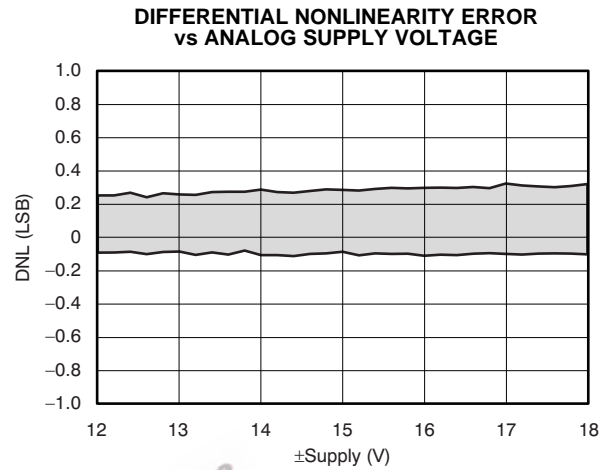

Figure 22.

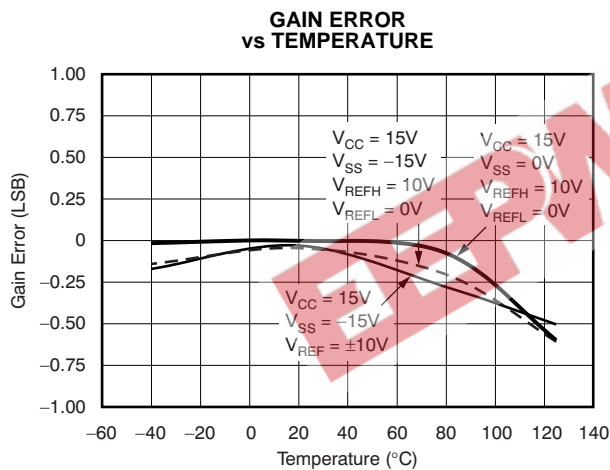

Figure 23.

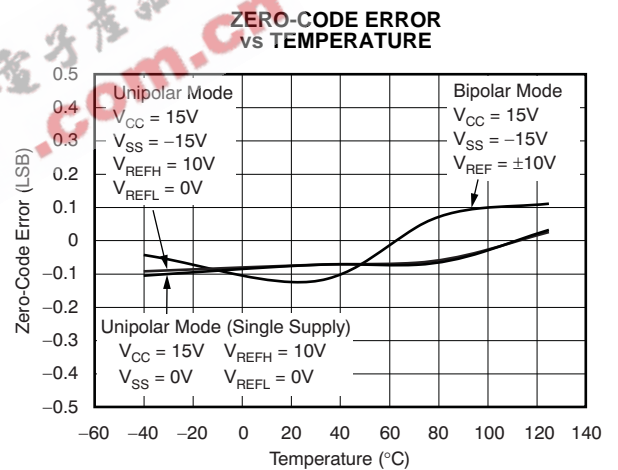

Figure 24.

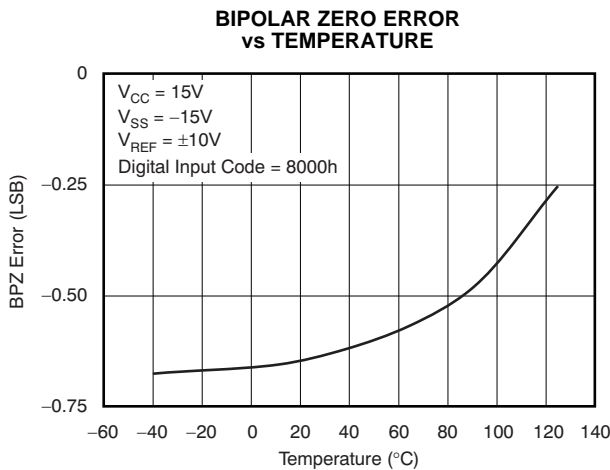

Figure 25.

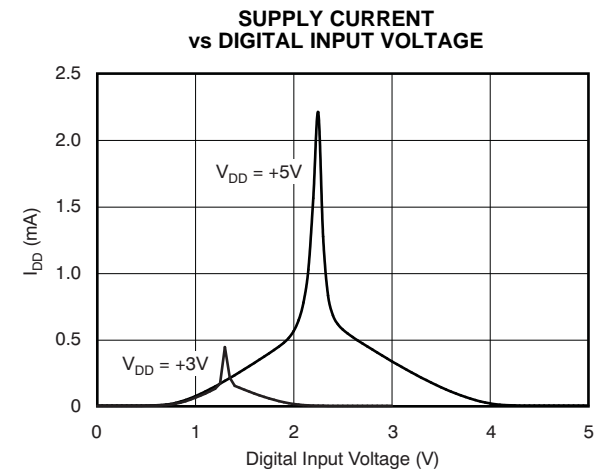

Figure 26.

TYPICAL CHARACTERISTICS (continued)

At $T_A = +25^\circ\text{C}$, $V_{DD} = +5\text{V}$, $V_{CC} = +15\text{V}$, $V_{SS} = -15\text{V}$, $V_{REFH} = +10\text{V}$, and $V_{REFL} = -10\text{V}$, unless otherwise noted.

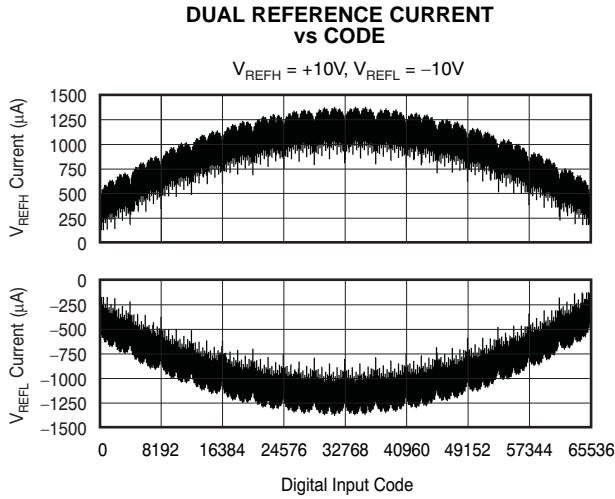

Figure 27.

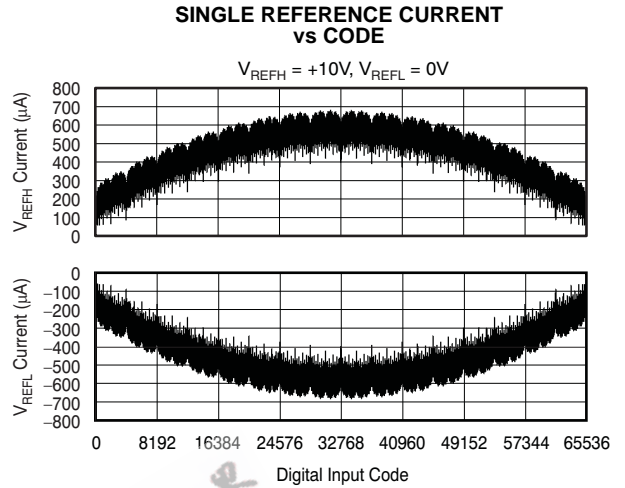

Figure 28.

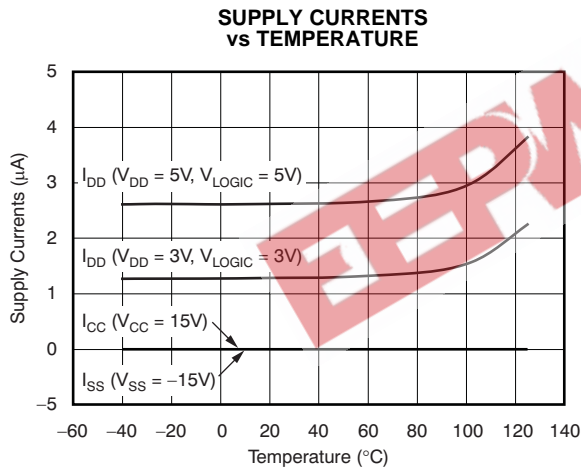

Figure 29.

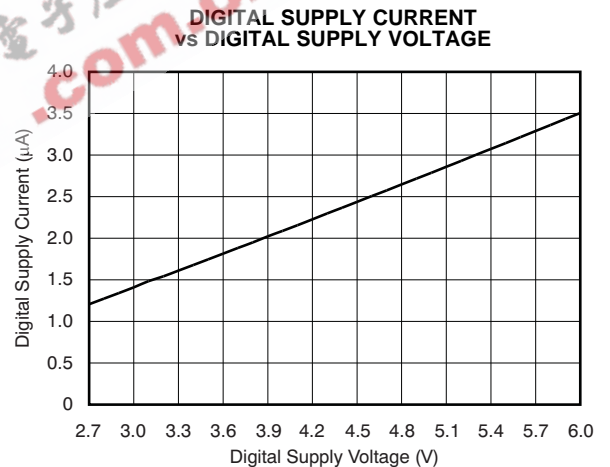

Figure 30.

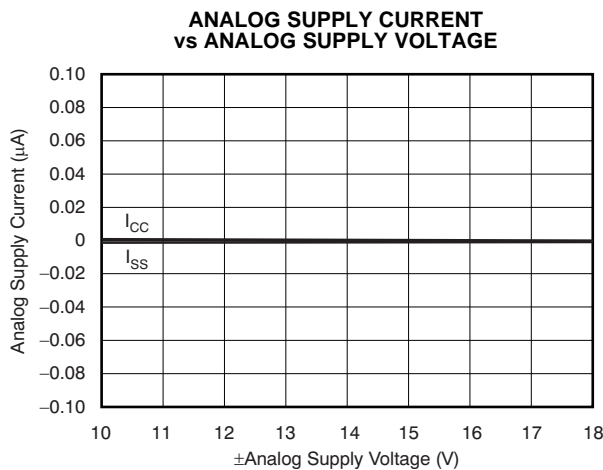

Figure 31.

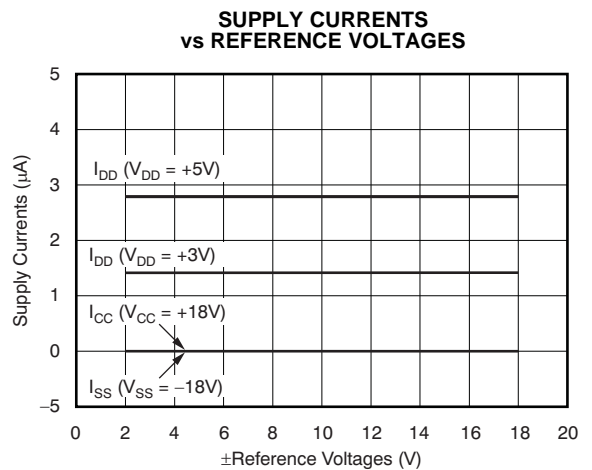

Figure 32.

TYPICAL CHARACTERISTICS (continued)

At $T_A = +25^\circ\text{C}$, $V_{DD} = +5\text{V}$, $V_{CC} = +15\text{V}$, $V_{SS} = -15\text{V}$, $V_{REFH} = +10\text{V}$, and $V_{REFL} = -10\text{V}$, unless otherwise noted.

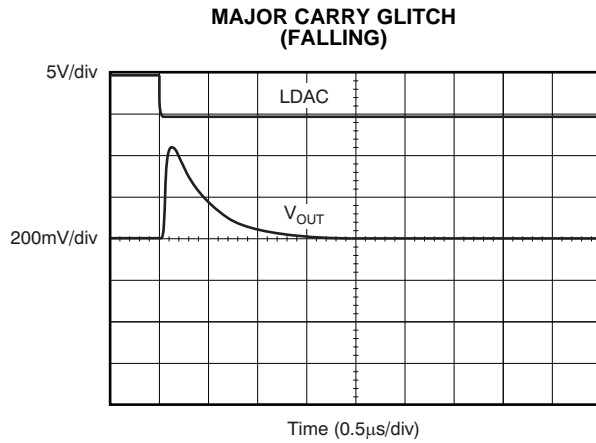

Figure 33.

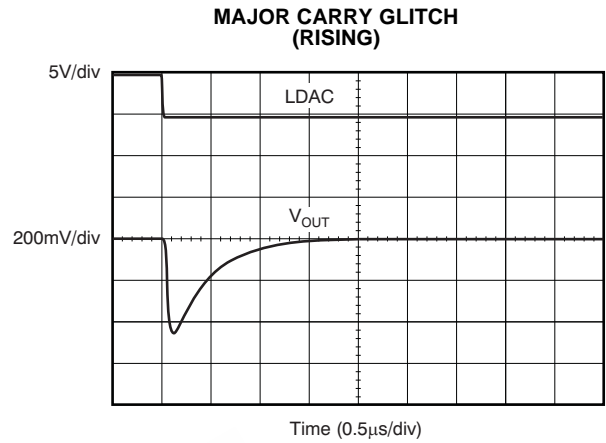

Figure 34.

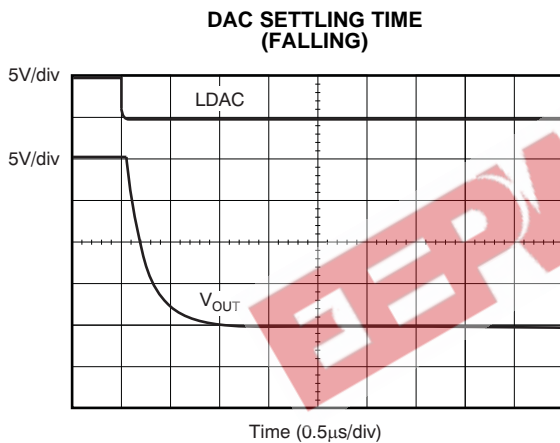

Figure 35.

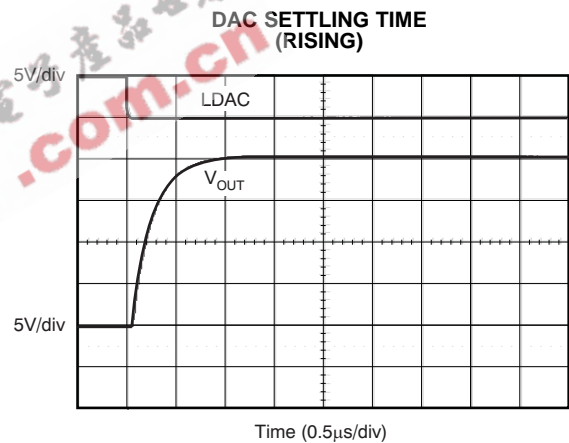

Figure 36.

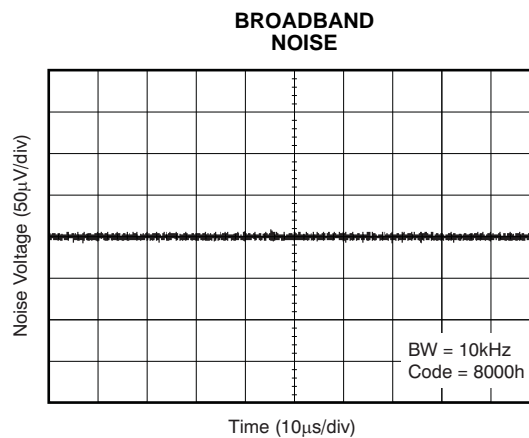

Figure 37.

THEORY OF OPERATION

GENERAL DESCRIPTION

The DAC8871 is a 16-bit, single-channel, serial-input, voltage-output DAC. It operates from a dual power supply ranging from ±13.5V to ±19.8V, and typically consumes 10µA. The output range is from V_{REFL} to V_{REFH} . Data are written to this device in a 16-bit word format, via an SPI serial interface. To ensure a known power-up state, the DAC8871 is designed with a power-on reset function. After power on, the state of the RSTSEL pin sets the value of the input register and DAC latch, which sets the output state of the V_{OUT} pin. Refer to the [Power-On Reset and Hardware Reset](#) section for more details.

Kelvin sense connections for the reference and analog ground are also included.

DIGITAL-TO-ANALOG SECTIONS

The DAC architecture consists of two matched DAC sections and is segmented. A simplified circuit diagram is shown in [Figure 38](#). The four MSBs of the 16-bit data word are decoded to drive 15 switches, E1 to E15. Each of these switches connects one of 15 matched resistors to either AGND or V_{REF} . The remaining 12 bits of the data word drive switches S0 to S11 of a 12-bit voltage mode R-2R ladder network.

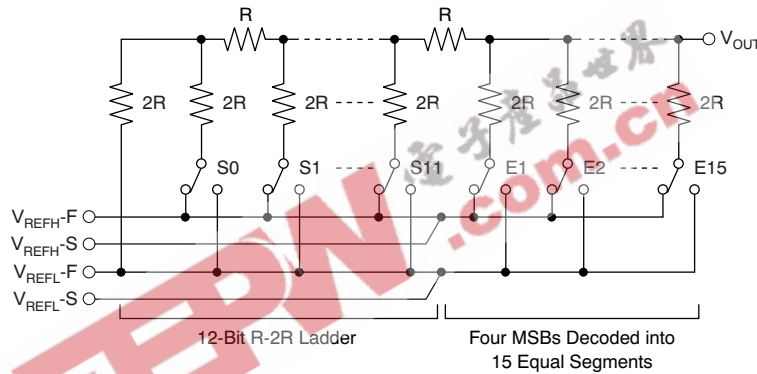

Figure 38. DAC Architecture

OUTPUT RANGE

The output of the DAC is:

$$V_{OUT} = \frac{(V_{REFH} - V_{REFL}) \times Code}{65536 + V_{REFL}} \tag{1}$$

Where *Code* is the decimal data word loaded to the DAC latch.

For example, if V_{REFH} is +10V, and V_{REFL} is -10V, the range of V_{OUT} is from -10V (code = 0000h) to +10V (code = FFFFh).

The range of V_{REFL} is from -18V to ($V_{REFH} - 1.25V$), and the range of V_{REFH} is 0V to +18V. The output from the DAC8871 can be unipolar (from 0V to +18V) or bipolar by setting the proper V_{REFL} and V_{REFH} values.

THEORY OF OPERATION (continued)

POWER-ON RESET AND HARDWARE RESET

The DAC8871 has a power-on reset function. When the RSTSEL pin is low (tied to DGND), and after power-on or a hardware reset signal is applied to the $\overline{\text{RST}}$ pin, the DAC latch is cleared ('0') and the V_{OUT} pin is set to negative full-scale. When RSTSEL is high, the DAC latch and V_{OUT} are set to mid-scale.

SERIAL INTERFACE

The DAC8871 digital interface is a standard 3-wire connection compatible with SPI, QSPI™, Microwire™ and TI DSP™ interfaces, which can operate at speeds up to 50 Mbits/second. The data transfer is framed by the chip select ($\overline{\text{CS}}$) signal. The DAC works as a bus slave. The bus master generates the synchronize clock (SCLK) and initiates the transmission. When $\overline{\text{CS}}$ is high, the DAC is not accessed, and SCLK and SDI are ignored. The bus master accesses the DAC by driving $\overline{\text{CS}}$ low. Immediately following the high-to-low transition of $\overline{\text{CS}}$, the serial input data on the SDI pin are shifted out from the bus master synchronously on the falling edge of SCLK and latched on the rising edge of SCLK into the input shift register, MSB first. The low-to-high transition of $\overline{\text{CS}}$ transfers the content of the input shift register to the input register.

All data registers are 16 bits. It takes 16 SCLK cycles to transfer one data word to the device. To complete a whole data word, $\overline{\text{CS}}$ must be taken high immediately after the 16th SCLK is clocked in. If more than 16 SCLK cycles are applied while $\overline{\text{CS}}$ is low, the last 16 bits are transferred into the input register on the rising edge of $\overline{\text{CS}}$. However, if $\overline{\text{CS}}$ is not kept low during the entire 16 SCLK cycles, the data are corrupted. In this case, reload the DAC latch with a new 16-bit word.

The DAC8871 has an $\overline{\text{LDAC}}$ pin that allows the DAC latch to be updated asynchronously by bringing $\overline{\text{LDAC}}$ low after $\overline{\text{CS}}$ goes high. In this case, $\overline{\text{LDAC}}$ must be kept high while $\overline{\text{CS}}$ is low. If $\overline{\text{LDAC}}$ is permanently tied low, the DAC latch will be updated immediately after the input register is loaded (caused by the low-to-high transition of $\overline{\text{CS}}$).

EXTERNAL AMPLIFIER SELECTION

The output of the DAC8871 is unbuffered. The output impedance is approximately 6.2k Ω . If the applications require an external buffer amplifier, the selected amplifier must have a low-offset voltage (1LSB = 305 μV for $\pm 10\text{V}$ output range), eliminating the need for output offset trims. Input bias current should also be low because the bias current multiplied by the DAC output impedance (approximately 6.25k Ω) adds to the zero-code error. Rail-to-rail input and output performance is required. For fast settling, the slew rate of the operational amplifier should not impede the settling time of the DAC. The output impedance of the DAC is constant and code-independent, but in order to minimize gain errors, the input impedance of the output amplifier should be as high as possible. The amplifier should also have a 3dB bandwidth of 1MHz or greater. The amplifier adds another time constant to the system, thus increasing the settling time of the output. A higher 3dB amplifier bandwidth results in a shorter effective settling time of the DAC and amplifier combination.

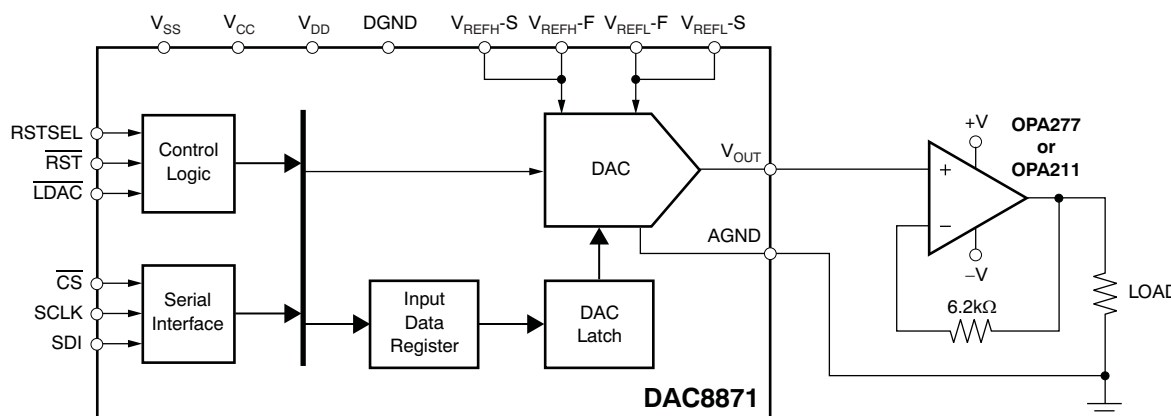

Figure 39. DAC8871 with External Amplifier

APPLICATION INFORMATION

REFERENCE INPUT

The DAC full-scale output voltage is determined by the reference voltage, as shown in the [Output Range](#) section.

Reference input V_{REFH} can be any voltage from 0V to +18V. Reference input V_{REFL} can be any voltage from –18V to 0V. The current into the V_{REFH} input and out of V_{REFL} depends on the DAC output voltages. Refer to [Figure 27](#) and [Figure 28](#) for details. The reference input appears as a varying load to the reference. If the reference can sink or source the required current, a reference buffer is not required. The DAC8871 features a reference drive (force) and sense connection that minimizes the internal errors caused by the changing reference current and the circuit impedances. [Figure 40](#) shows a typical reference configuration.

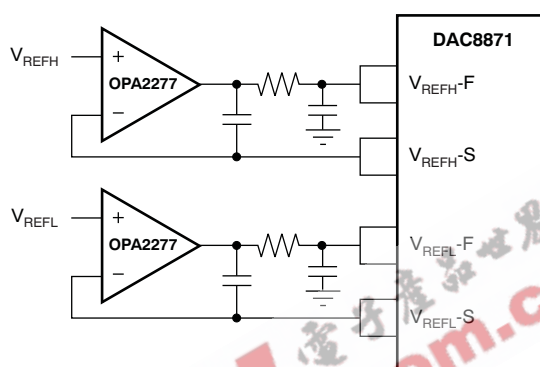

Figure 40. Buffered Reference Connection

POWER SUPPLY BYPASSING

For accurate, high-resolution performance, bypassing the supply pins with a 10 μ F tantalum capacitor in parallel with a 0.1 μ F ceramic capacitor is recommended.

PACKAGING INFORMATION

Orderable Device	Status ⁽¹⁾	Package Type	Package Drawing	Pins	Package Qty	Eco Plan ⁽²⁾	Lead/Ball Finish	MSL Peak Temp ⁽³⁾
DAC8871SBPW	ACTIVE	TSSOP	PW	16	90	Green (RoHS & no Sb/Br)	Call TI	Level-2-260C-1 YEAR
DAC8871SBPWG4	ACTIVE	TSSOP	PW	16	90	Green (RoHS & no Sb/Br)	Call TI	Level-2-260C-1 YEAR
DAC8871SBPWR	ACTIVE	TSSOP	PW	16	2000	Green (RoHS & no Sb/Br)	Call TI	Level-2-260C-1 YEAR
DAC8871SBPWRG4	ACTIVE	TSSOP	PW	16	2000	Green (RoHS & no Sb/Br)	Call TI	Level-2-260C-1 YEAR
DAC8871SPW	ACTIVE	TSSOP	PW	16	90	Green (RoHS & no Sb/Br)	Call TI	Level-2-260C-1 YEAR
DAC8871SPWG4	ACTIVE	TSSOP	PW	16	90	Green (RoHS & no Sb/Br)	Call TI	Level-2-260C-1 YEAR
DAC8871SPWR	ACTIVE	TSSOP	PW	16	2000	Green (RoHS & no Sb/Br)	Call TI	Level-2-260C-1 YEAR
DAC8871SPWRG4	ACTIVE	TSSOP	PW	16	2000	Green (RoHS & no Sb/Br)	Call TI	Level-2-260C-1 YEAR

⁽¹⁾ The marketing status values are defined as follows:

ACTIVE: Product device recommended for new designs.

LIFEBUY: TI has announced that the device will be discontinued, and a lifetime-buy period is in effect.

NRND: Not recommended for new designs. Device is in production to support existing customers, but TI does not recommend using this part in a new design.

PREVIEW: Device has been announced but is not in production. Samples may or may not be available.

OBSOLETE: TI has discontinued the production of the device.

⁽²⁾ Eco Plan - The planned eco-friendly classification: Pb-Free (RoHS), Pb-Free (RoHS Exempt), or Green (RoHS & no Sb/Br) - please check <http://www.ti.com/productcontent> for the latest availability information and additional product content details.

TBD: The Pb-Free/Green conversion plan has not been defined.

Pb-Free (RoHS): TI's terms "Lead-Free" or "Pb-Free" mean semiconductor products that are compatible with the current RoHS requirements for all 6 substances, including the requirement that lead not exceed 0.1% by weight in homogeneous materials. Where designed to be soldered at high temperatures, TI Pb-Free products are suitable for use in specified lead-free processes.

Pb-Free (RoHS Exempt): This component has a RoHS exemption for either 1) lead-based flip-chip solder bumps used between the die and package, or 2) lead-based die adhesive used between the die and leadframe. The component is otherwise considered Pb-Free (RoHS compatible) as defined above.

Green (RoHS & no Sb/Br): TI defines "Green" to mean Pb-Free (RoHS compatible), and free of Bromine (Br) and Antimony (Sb) based flame retardants (Br or Sb do not exceed 0.1% by weight in homogeneous material)

⁽³⁾ MSL, Peak Temp. -- The Moisture Sensitivity Level rating according to the JEDEC industry standard classifications, and peak solder temperature.

Important Information and Disclaimer:The information provided on this page represents TI's knowledge and belief as of the date that it is provided. TI bases its knowledge and belief on information provided by third parties, and makes no representation or warranty as to the accuracy of such information. Efforts are underway to better integrate information from third parties. TI has taken and continues to take reasonable steps to provide representative and accurate information but may not have conducted destructive testing or chemical analysis on incoming materials and chemicals. TI and TI suppliers consider certain information to be proprietary, and thus CAS numbers and other limited information may not be available for release.

In no event shall TI's liability arising out of such information exceed the total purchase price of the TI part(s) at issue in this document sold by TI to Customer on an annual basis.

MECHANICAL DATA

MTSS001C – JANUARY 1995 – REVISED FEBRUARY 1999

PW (R-PDSO-G**)

PLASTIC SMALL-OUTLINE PACKAGE

14 PINS SHOWN



4040064/F 01/97

- NOTES: A. All linear dimensions are in millimeters.
 B. This drawing is subject to change without notice.
 C. Body dimensions do not include mold flash or protrusion not to exceed 0,15.
 D. Falls within JEDEC MO-153

IMPORTANT NOTICE

Texas Instruments Incorporated and its subsidiaries (TI) reserve the right to make corrections, modifications, enhancements, improvements, and other changes to its products and services at any time and to discontinue any product or service without notice. Customers should obtain the latest relevant information before placing orders and should verify that such information is current and complete. All products are sold subject to TI's terms and conditions of sale supplied at the time of order acknowledgment.

TI warrants performance of its hardware products to the specifications applicable at the time of sale in accordance with TI's standard warranty. Testing and other quality control techniques are used to the extent TI deems necessary to support this warranty. Except where mandated by government requirements, testing of all parameters of each product is not necessarily performed.

TI assumes no liability for applications assistance or customer product design. Customers are responsible for their products and applications using TI components. To minimize the risks associated with customer products and applications, customers should provide adequate design and operating safeguards.

TI does not warrant or represent that any license, either express or implied, is granted under any TI patent right, copyright, mask work right, or other TI intellectual property right relating to any combination, machine, or process in which TI products or services are used. Information published by TI regarding third-party products or services does not constitute a license from TI to use such products or services or a warranty or endorsement thereof. Use of such information may require a license from a third party under the patents or other intellectual property of the third party, or a license from TI under the patents or other intellectual property of TI.

Reproduction of TI information in TI data books or data sheets is permissible only if reproduction is without alteration and is accompanied by all associated warranties, conditions, limitations, and notices. Reproduction of this information with alteration is an unfair and deceptive business practice. TI is not responsible or liable for such altered documentation. Information of third parties may be subject to additional restrictions.

Resale of TI products or services with statements different from or beyond the parameters stated by TI for that product or service voids all express and any implied warranties for the associated TI product or service and is an unfair and deceptive business practice. TI is not responsible or liable for any such statements.

TI products are not authorized for use in safety-critical applications (such as life support) where a failure of the TI product would reasonably be expected to cause severe personal injury or death, unless officers of the parties have executed an agreement specifically governing such use. Buyers represent that they have all necessary expertise in the safety and regulatory ramifications of their applications, and acknowledge and agree that they are solely responsible for all legal, regulatory and safety-related requirements concerning their products and any use of TI products in such safety-critical applications, notwithstanding any applications-related information or support that may be provided by TI. Further, Buyers must fully indemnify TI and its representatives against any damages arising out of the use of TI products in such safety-critical applications.

TI products are neither designed nor intended for use in military/aerospace applications or environments unless the TI products are specifically designated by TI as military-grade or "enhanced plastic." Only products designated by TI as military-grade meet military specifications. Buyers acknowledge and agree that any such use of TI products which TI has not designated as military-grade is solely at the Buyer's risk, and that they are solely responsible for compliance with all legal and regulatory requirements in connection with such use.

TI products are neither designed nor intended for use in automotive applications or environments unless the specific TI products are designated by TI as compliant with ISO/TS 16949 requirements. Buyers acknowledge and agree that, if they use any non-designated products in automotive applications, TI will not be responsible for any failure to meet such requirements.

Following are URLs where you can obtain information on other Texas Instruments products and application solutions:

Products		Applications	
Amplifiers	amplifier.ti.com	Audio	www.ti.com/audio
Data Converters	dataconverter.ti.com	Automotive	www.ti.com/automotive
DSP	dsp.ti.com	Broadband	www.ti.com/broadband
Interface	interface.ti.com	Digital Control	www.ti.com/digitalcontrol
Logic	logic.ti.com	Military	www.ti.com/military
Power Mgmt	power.ti.com	Optical Networking	www.ti.com/opticalnetwork
Microcontrollers	microcontroller.ti.com	Security	www.ti.com/security
RFID	www.ti-rfid.com	Telephony	www.ti.com/telephony
Low Power Wireless	www.ti.com/lpw	Video & Imaging	www.ti.com/video
		Wireless	www.ti.com/wireless

Mailing Address: Texas Instruments, Post Office Box 655303, Dallas, Texas 75265
Copyright © 2007, Texas Instruments Incorporated