

DB15-005 ... DB15-16
Three-Phase Si-Bridge-Rectifiers
Dreiphasen-Si-Brückengleichrichter

Version 2007-03-15

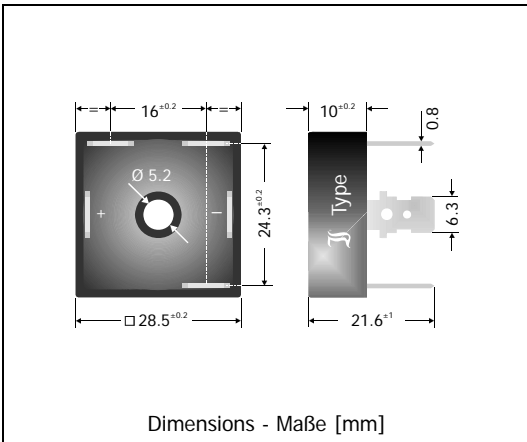

Nominal current Nennstrom	15 A
Repetitive peak reverse voltage Periodische Spitzensperrspannung	50...1600 V
Plastic case with alu bottom Plastikgehäuse mit Alu-Boden	28.5 x 28.5 x 10 [mm]
Weight approx. – Gewicht ca.	21 g
Compound has classification UL94V-0 Vergussmasse nach UL94V-0 klassifiziert	
Standard packaging bulk Standard Lieferform lose im Karton	



Recognized Product – Underwriters Laboratories Inc.® File E175067
 Anerkanntes Produkt – Underwriters Laboratories Inc.® Nr. E175067

Maximum ratings

Grenzwerte

Type Typ	Max. alternating input voltage Max. Eingangswchelsspannung V_{VRMS} [V]	Repetitive peak reverse voltage Periodische Spitzensperrspannung V_{RRM} [V] ¹⁾
DB15-005	35	50
DB15-01	70	100
DB15-02	140	200
DB15-04	280	400
DB15-06	420	600
DB15-08	560	800
DB15-10	700	1000
DB15-12	800	1200
DB15-14	900	1400
DB15-16	1000	1600

1 Valid for one branch – Gültig für einen Brückenweig

Maximum ratings
Grenzwerte

Repetitive peak forward current Periodischer Spitzenstrom	$f > 15 \text{ Hz}$	I_{FRM}	80 A ¹⁾
Peak forward surge current 50 Hz half sine-wave Stoßstrom für eine 50 Hz Sinus-Halbwellen	$T_A = 25^\circ\text{C}$	I_{FSM}	250 A
Peak forward surge current 60 Hz half sine-wave Stoßstrom für eine 60 Hz Sinus-Halbwellen	$T_A = 25^\circ\text{C}$	I_{FSM}	275 A
Rating for fusing, $t < 10 \text{ ms}$ Grenzlastintegral, $t < 10 \text{ ms}$	$T_A = 25^\circ\text{C}$	i^2t	330 A ² s
Operating junction temperature – Sperrschichttemperatur Storage temperature – Lagerungstemperatur		T_j T_s	-50...+150°C -50...+150°C

Characteristics
Kennwerte

Max. current with cooling fin 300 cm ² Dauergrenzstrom mit Kühlblech 300 cm ²	$T_A = 50^\circ\text{C}$	R-load C-load	I_{FAV} I_{FAV}	15 A 15 A
Forward voltage – Durchlass-Spannung	$T_j = 25^\circ\text{C}$	$I_F = 7.5 \text{ A}$	V_F	< 1.05 V ²⁾
Leakage current – Sperrstrom	$T_j = 25^\circ\text{C}$	$V_R = V_{RRM}$	I_R	< 10 µA
Isolation voltage terminals to case Isolationsspannung Anschlüsse zum Gehäuse			V_{ISO}	> 2500 V
Thermal resistance junction to case Wärmewiderstand Sperrschicht – Gehäuse			R_{thc}	< 3.3 K/W
Admissible torque for mounting Zulässiges Anzugsdrehmoment		10-32 UNF M5		18 ± 10% lb.in. 2 ± 10% Nm

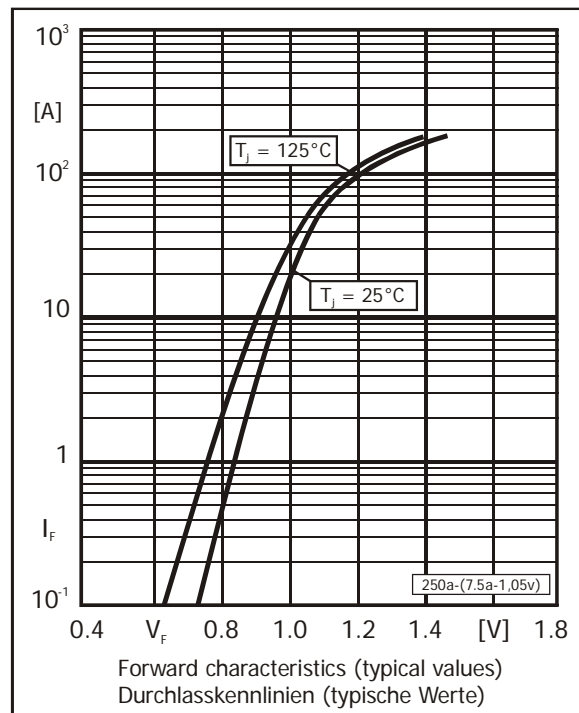
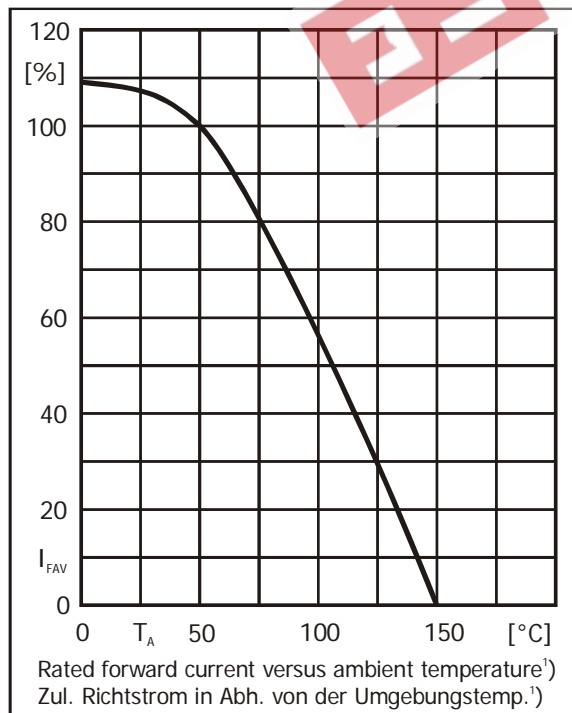

1 Valid, if the temperature of the case is kept to $T_c = 120^\circ\text{C}$ – Gültig, wenn die Gehäusetemperatur auf $T_c = 120^\circ\text{C}$ gehalten wird
 2 Valid for one branch – Gültig für einen Brückenweig