

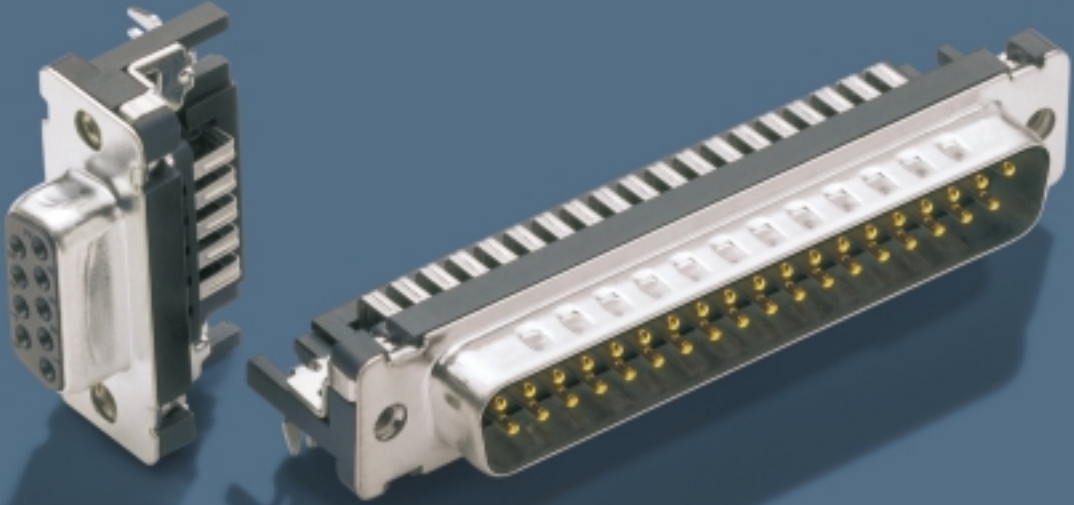

电子产品世界
EEPW.com.cn

Eurostyle D Subminiature Connectors



Cannon



ITT Industries
Engineered for life

Introduction

The D Subminiature Eurostyle connector is a product line extension of the well known D Subminiature family originally invented by ITT Industries, Cannon.

It is a special low profile 90° solder pin connector acc. to the CECC75 301 802 European specification. It replaces the D* version with the code 1AEN which was not 100% in line with above mentioned specification.

The main applications will be found in industrial as well as in telecommunication equipment. The major advantage for the end user is to achieve additional space due to the low profile configuration.

The D Subminiature Eurostyle connectors are fully mateable with all standard D Subminiature connectors according to DIN 41652.

Product features

- ◆ Meets European Eurostyle specification CECC75 301 802
- ◆ Available in all common layouts (9, 15, 25, 37-way), male and female
- ◆ Available in Performance Classes 1, 2 and 3 according to DIN 41652
- ◆ Clinch nut with M3 or 4-40 UNC thread
- ◆ Jack Post with M3 or 4-40 UNC thread

Technical Data

Materials and Finishes

| | |
|------------------------------|---------------------------------------|
| Shell | Steel, tin plated |
| Insulator | Thermoplastic, UL 94V-0 |
| Contacts | Copper alloy, gold over nickel plated |
| Boardlock / Grounding Insert | Brass, tin plated |
| Threaded insert | Steel, tin plated |

Electrical Data

| | |
|----------------------------|----------------------------------|
| Current rating temperature | 5 A / 25°C, 3,5 A / 70°C ambient |
| Test voltage | 1000 V ac rms at sea level |
| Insulation resistance | 5 G Ω min. |
| Contact resistance | 25 m Ω |

Mechanical Data

| | |
|--------------------------------|---|
| Polarizing | Keystone shaped front shell |
| Number of contacts | 9, 15, 25 and 37 |
| Termination method | Solder pin 90° Eurostyle acc. CECC 75301802 |
| Performance class 3 (Standard) | 50 mating cycles (without code) |
| Performance class 2 | 200 mating cycles (code -A191) |
| Performance class 1 | 500 mating cycles (code -A190) |
| Operating temperature | - 55°C to 125°C |

Order Reference Explanation

D A N E - 15 S - L 1 - E 03 - *

Series Prefix

Cannon designation

Shell size

E - 9 way

A - 15 way

B - 25 way

C - 37 way

Class

N - new generation

Termination / Mounting

E - 90° pushfit / row spacing 2,54

F - 90° pushfit / row spacing 2,84

Number of contacts

9, 15, 25, 37

Contact gender

P - pin contact

S - socket contact

Contact termination

L - solder pin

Pushfit Type

0 - no pushfit

1 - for pcb 1,6

2 - for pcb 2,4

3 - for pcb 3,2

Mounting height

E - Euro 3,6

Locking

03 - M3 thread

04 - 4-40 UNC thread

13 - M3 thread with jackpost

14 - 4-40 UNC thread with jackpost

Modification

no code - performance class 3

A191 - performance class 2

A190 - performance class 1

Part numbers in **red letter** typeface indicate standard products: usually available with shorter lead times.

Pin Connector 90°

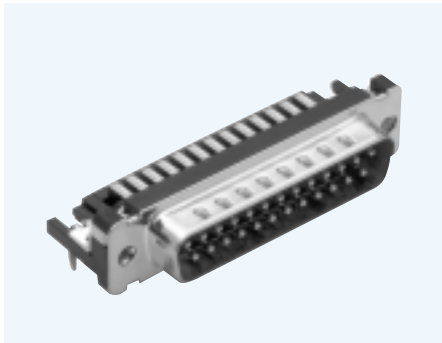

Part numbers Pin

| Shell size | Layout | Clinch nut 4-40 UNC | Clinch nut M3 |
|------------|--------|----------------------|----------------------|
| DE | 9 | DENE-9P-L1-E04-A191 | DENE-9P-L1-E03-A191 |
| DA | 15 | DANE-15P-L1-E04-A191 | DANE-15P-L1-E03-A191 |
| DB | 25 | DBNE-25P-L1-E04-A191 | DBNE-25P-L1-E03-A191 |
| DC | 37 | DCNE-37P-L1-E04-A191 | DCNE-37P-L1-E03-A191 |

| Shell size | Layout | Jackpost 4-40 UNC | Jackpost M3 |
|------------|--------|----------------------|----------------------|
| DE | 9 | DENE-9P-L1-E14-A191 | DENE-9P-L1-E13-A191 |
| DA | 15 | DANE-15P-L1-E14-A191 | DANE-15P-L1-E13-A191 |
| DB | 25 | DBNE-25P-L1-E14-A191 | DBNE-25P-L1-E13-A191 |
| DC | 37 | DCNE-37P-L1-E14-A191 | DCNE-37P-L1-E13-A191 |

Part numbers in **red letter** typeface indicate standard products: usually available with shorter lead times.

Note: For performance class 1 replace A-191 by -A190;

For performance class 3 delete -A191.

For row spacing 2,84 mm replace D*NE with D*Nf

Example: DENE-9P-L1-E13

Example: DANF-15P-L1-A191

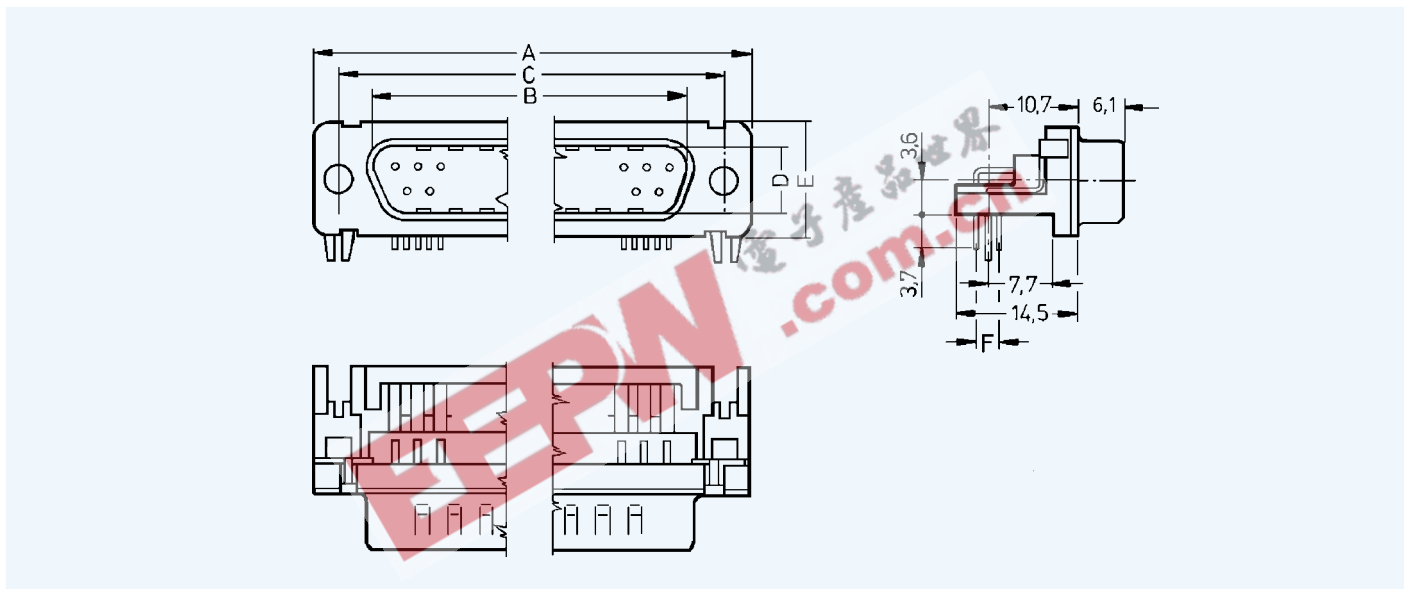

| Shell size | Contacts | A - 0,7 | B + 0,25 | C ± 0,1 | D + 0,25 | E - 0,7 | F |
|------------|----------|---------|----------|---------|----------|---------|--------------|
| DE | 9 | 31,20 | 16,79 | 25,00 | 8,23 | 12,90 | 2,54 or 2,84 |
| DA | 15 | 39,50 | 25,12 | 33,35 | 8,23 | 12,90 | 2,54 or 2,84 |
| DB | 25 | 53,40 | 38,84 | 47,04 | 8,23 | 12,90 | 2,54 or 2,84 |
| DC | 37 | 69,70 | 55,30 | 63,50 | 8,23 | 12,90 | 2,54 or 2,84 |

pushfit

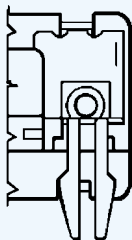

clinch nut

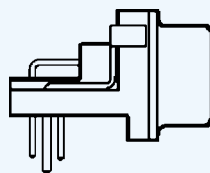

03 - M3 thread
04 - 4-40 UNC thread

Jackpost

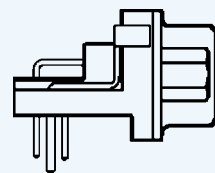

13 - M3 thread
14 - 4-40 UNC thread

Socket Connector 90°

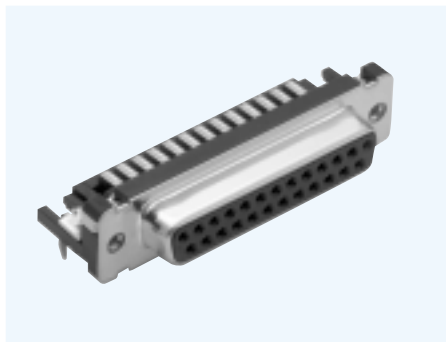

Part numbers Socket

| Shell size | Layout | Clinch nut 4-40 UNC | Clinch nut M3 |
|------------|--------|-----------------------------|----------------------|
| DE | 9 | DENE-9S-L1-E04-A191 | DENE-9S-L1-E03-A191 |
| DA | 15 | DANE-15S-L1-E04-A191 | DANE-15S-L1-E03-A191 |
| DB | 25 | DBNE-25S-L1-E04-A191 | DBNE-25S-L1-E03-A191 |
| DC | 37 | DCNE-37S-L1-E04-A191 | DCNE-37S-L1-E03-A191 |

| Shell size | Layout | Jackpost 4-40 UNC | Jackpost M3 |
|------------|--------|-----------------------------|----------------------|
| DE | 9 | DENE-9S-L1-E14-A191 | DENE-9S-L1-E13-A191 |
| DA | 15 | DANE-15S-L1-E14-A191 | DANE-15S-L1-E13-A191 |
| DB | 25 | DBNE-25S-L1-E14-A191 | DBNE-25S-L1-E13-A191 |
| DC | 37 | DCNE-37S-L1-E14-A191 | DCNE-37S-L1-E13-A191 |

Part numbers in **red letter** typeface indicate standard products: usually available with shorter lead times.

Note: For performance class 1 replace A-191 by -A190;

For performance class 3 delete -A191.

For row spacing 2,84 mm replace D*NE with D*Nf

Example: DENE-9S-L1-E13

Example: DANF-15S-L1-A191

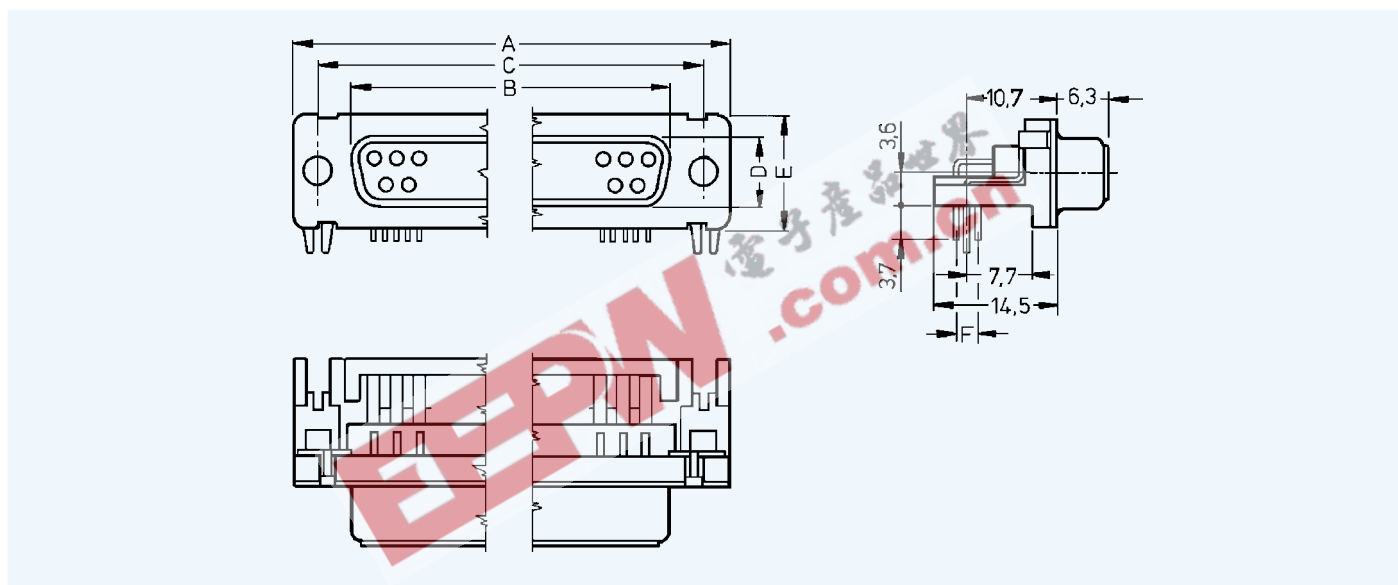

| Shell size | Contacts | A - 0,7 | B - 0,25 | C ± 0,1 | D - 0,25 | E - 0,7 | F |
|------------|----------|---------|----------|---------|----------|---------|--------------|
| DE | 9 | 31,20 | 16,46 | 25,00 | 8,02 | 12,90 | 2,54 or 2,84 |
| DA | 15 | 39,50 | 24,79 | 33,35 | 8,02 | 12,90 | 2,54 or 2,84 |
| DB | 25 | 53,40 | 38,50 | 47,04 | 8,02 | 12,90 | 2,54 or 2,84 |
| DC | 37 | 69,70 | 54,96 | 63,50 | 8,02 | 12,90 | 2,54 or 2,84 |

pushfit

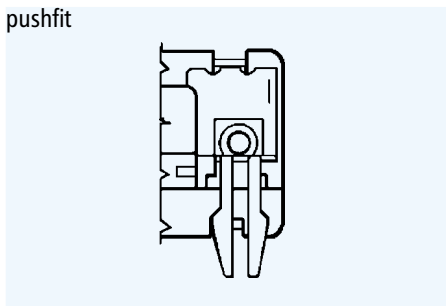

clinch nut

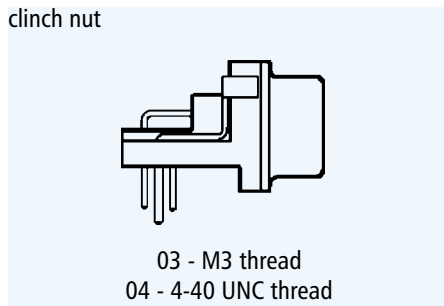

Jackpost

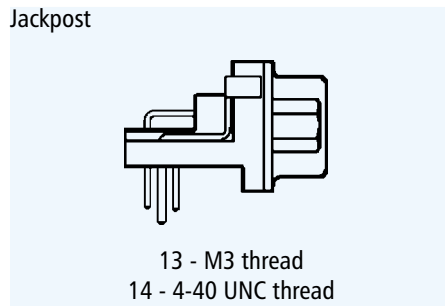

Contact Arrangements
Face View Pin Insert

Standard

PC Board Hole pattern - 90° European

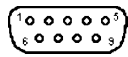

| | |
|---------------------|----|
| Shell size | E |
| Contact arrangement | 9 |
| Contact size | 20 |

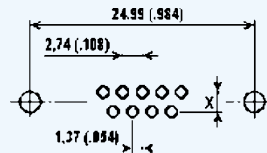

Dimension X

Termination / Mounting

E - 90° pushfit / row spacing 2,54, F - 90° pushfit / row spacing 2,84

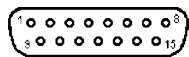

| | |
|---------------------|----|
| Shell size | A |
| Contact arrangement | 15 |
| Contact size | 20 |

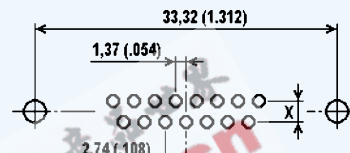

Dimension X

Termination / Mounting

E - 90° pushfit / row spacing 2,54, F - 90° pushfit / row spacing 2,84

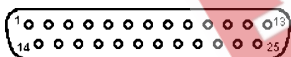

| | |
|---------------------|----|
| Shell size | B |
| Contact arrangement | 25 |
| Contact size | 20 |

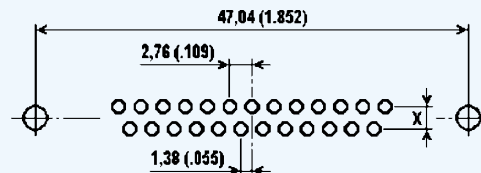

Dimension X

Termination / Mounting

E - 90° pushfit / row spacing 2,54, F - 90° pushfit / row spacing 2,84

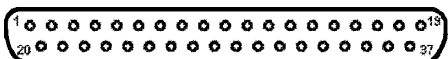

| | |
|---------------------|----|
| Shell size | C |
| Contact arrangement | 37 |
| Contact size | 20 |

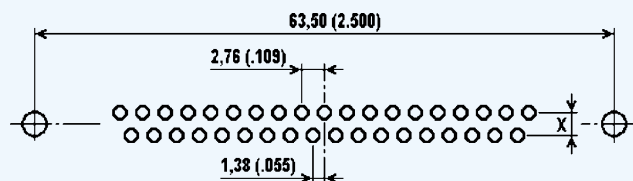

Dimension X

Termination / Mounting

E - 90° pushfit / row spacing 2,54, F - 90° pushfit / row spacing 2,84

| Signal Contact Ø | Recommended PCB Hole Ø | Mounting Type | Recommended PCB Hole Ø |
|------------------|------------------------|---------------|------------------------|
| 0,60 | 1,00 | All | 3,10 |

Product Safety Information

THIS NOTE SHOULD BE READ IN CONJUNCTION WITH THE PRODUCT DATA SHEET/CATALOGUE. FAILURE TO OBSERVE THE ADVICE IN THIS INFORMATION SHEET AND THE OPERATING CONDITIONS SPECIFIED IN THE PRODUCT DATA SHEET/CATALOGUE COULD RESULT IN HAZARDOUS SITUATIONS.

1. MATERIAL CONTENT AND PHYSICAL FORM

Electrical connectors do not usually contain hazardous materials. They contain conducting and non-conducting materials and can be divided into two groups.

a) Printed circuit types and low cost audio types which employ all plastic insulators and casings.

b) Rugged, Fire Barrier and High Reliability types with metal casings and either natural rubber, synthetic rubber, plastic or glass insulating materials.

Contact materials vary with type of connector and also application and are usually manufactured from either copper, copper alloys, nickel, alumel, chromel or steel. In special applications, other alloys may be specified.

2. FIRE CHARACTERISTICS AND ELECTRIC SHOCK HAZARD

There is no fire hazard when the connector is correctly wired and used within the specified parameters. Incorrect wiring or assembly of the connector or careless use of metal tools or conductive fluids, or transit damage to any of the component parts may cause electric shock or burns. Live circuits must not be broken by separating mated connectors as this may cause arcing, ionisation and burning.

Heat dissipation is greater at maximum resistance in a circuit. Hot spots may occur when resistance is raised locally by damage, e.g. cracked or deformed contacts, broken strands of wire. Local overheating may also result from the use of the incorrect application tools or from poor quality soldering or slack screw terminals. Overheating may occur if the ratings in the Product Data Sheet/Catalogue are exceeded and can cause breakdown of insulation and hence electric shock.

If heating is allowed to continue it intensifies by further increasing the local resistance through loss of temper of spring contacts, formation of oxide film on contacts and wires, and leakage currents through carbonisation of insulation and tracking paths. Fire can then result in the

presence of combustible materials and this may release noxious fumes. Overheating may not be visually apparent. Burns may result from touching overheated components.

3. HANDLING

Care must be taken to avoid damage to any component parts of electrical connectors during installation and use. Although there are normally no sharp edges, care must be taken when handling certain components to avoid injury to fingers.

Electrical connectors may be damaged in transit to the customers, and damage may result in creation of hazards. Products should therefore be examined prior to installation/use and rejected if found to be damaged.

4. DISPOSAL

Incineration of certain materials may release noxious or even toxic fumes.

5. APPLICATION

Connectors with exposed contacts should not be selected for use on the current supply side of an electrical circuit, because an electric shock could result from touching exposed contacts on an unmated connector. Voltages in excess of 30 V ac or 42.5 V dc are potentially hazardous and care should be taken to ensure that such voltages can not be transmitted in any way to exposed metal parts of the connector body. The connector and wiring should be checked, before making live, to have no damage to metal parts or insulators, no solder blobs, loose strands, conducting lubricants, swarf, or any other undersired conducting particles. Circuit resistance and continuity check should be made to make certain that there are no high resistance joints or spurious conducting paths. Always use the correct application tools as specified in the Data Sheet / Catalogue.

Do not permit untrained personnel to wire, assemble or tamper with connectors. For operation voltage please see appropriate national regulations.

IMPORTANT GENERAL INFORMATION.

1. Air and creepage paths/Operating voltage

The admissible operating voltages depend on the individual applications and the valid national and other applicable safety regulations.

For this reason the air and creepage path data are only reference values. Observe reduction of air and creepage paths due to PC board and/or harnessing.

2. Temperature

All information given are temperature limits. The operation temperature depends on the individual application.

3. Other important information

Cannon continuously endeavours to improve their products. Therefore, Cannon products may deviate from the description, technical data and shape as shown in this catalogue and data sheets.

ITT Cannon, a division of ITT Industries, Inc. manufactures the highest quality products available in the marketplace; however these products are intended to be used in accordance with the specifications in this publication. Any use or application that deviates from stated operating specifications is not recommended and may be unsafe. No information and data contained in this publication shall be construed to create any liability on the part of Cannon. Any new issue of this publication shall automatically invalidate and supersede any and all previous issues. **A limited warranty applies to Cannon products. Except for obligations assumed by Cannon under this warranty, Cannon shall not be liable for any loss, damage, cost of repairs, incidental or consequential damages of any kind, whether or not based on express or implied warranty, contract, negligence or strict liability arising in connection with the design, manufacture, sale, use or repair of the products.** Product availability, prices and delivery dates are exclusively subject to our respective order confirmation form; the same applies to orders based on development samples delivered. This publication is not to be construed as an offer. It is intended merely as an invitation to make an offer. By this publication, Cannon does not assume responsibility or any liability for any patent infringements or other rights of third parties which may result from its use. Reprinting this publication is generally permitted, indicating the source. However, Cannon's prior consent must be obtained in all cases.

Cannon is a trademark of ITT Industries, Inc