

# DIODE MODULE

# DD55F/KD55F

UL:E76102(M)

Power Diode Module **DD55F** series are designed for various rectifier circuits. **DD55F** has two diode chips connected in series in 25mm (1inch) width package and the mounting base is electrically isolated from elements for simple heatsink construction. Wide voltage rating up to, 1,600V is available for various input voltage.

- Isolated mounting base
- Two elements in a package for simple (single and three phase) bridge connections
- Highly reliable glass passivated chips
- High surge current capability

### (Applications)

Various rectifiers, Battery chargers, DC motor drives

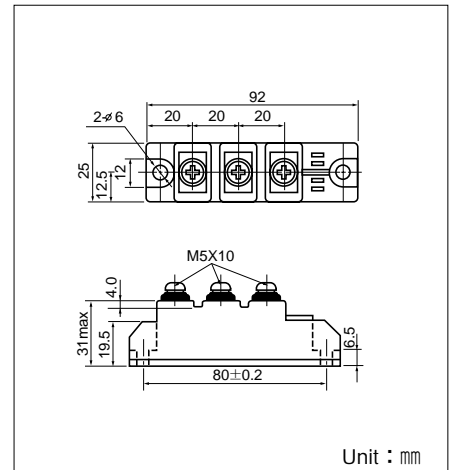
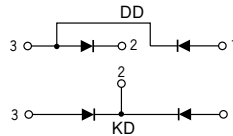

### Maximum Ratings

(T<sub>j</sub>=25°C unless otherwise specified)

Symbol	Item	Ratings				Unit
		DD55F40	DD55F80	DD55F120	DD55F160	
V <sub>RRM</sub>	Repetitive Peak Reverse Voltage	400	800	1200	1600	V
V <sub>RSM</sub>	Non-Repetitive Peak Reverse Voltage	480	960	1300	1700	V

Symbol	Item	Conditions	Ratings	Unit	
I <sub>F(AV)</sub>	Average Forward Current	Single phase, half wave, 180° conduction, T <sub>c</sub> : 89°C	55	A	
I <sub>F(RMS)</sub>	R.M.S. Forward Current	Single phase, half wave, 180° conduction, T <sub>c</sub> : 89°C	86	A	
I <sub>FSM</sub>	Surge Forward Current	1/2 cycle, 50/60Hz, peak value, non-repetitive	1600/1750	A	
I <sup>2</sup> t	I <sup>2</sup> t	Value for one cycle of surge current	12800	A <sup>2</sup> S	
V <sub>ISO</sub>	Isolation Breakdown Voltage (R.M.S.)	A.C. 1minute	2500	°C	
T <sub>j</sub>	Junction Temperature		-40 to +125	°C	
T <sub>stg</sub>	Storage Temperature		-40 to +125	V	
	Mounting Torque	Mounting (M5)	Recommended Value 1.5-2.5 (15-25)	2.7 (28)	N·m (kgf·cm)
		Terminal (M5)	Recommended Value 1.5-2.5 (15-25)	2.7 (28)	
	Mass			170	g

### Electrical Characteristics

Symbol	Item	Conditions	Ratings	Unit
I <sub>RRM</sub>	Repetitive Peak Reverse Current, max.	at V <sub>DRM</sub> , single phase, half wave. T <sub>j</sub> =125°C	15	mA
V <sub>FM</sub>	Forward Voltage Drop, max.	Forward current 170A, T <sub>j</sub> =25°C, Inst. measurement	1.40	V
R <sub>th(j-c)</sub>	Thermal Impedance, max.	Junction to case	0.50	°C/W

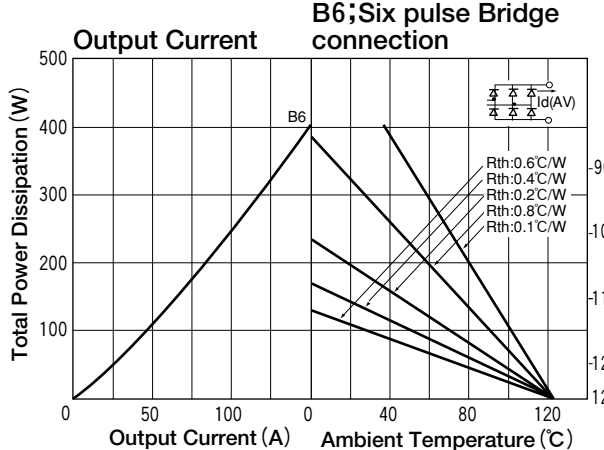
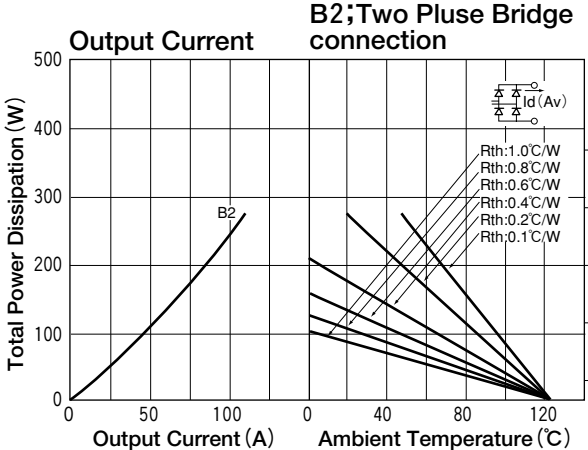
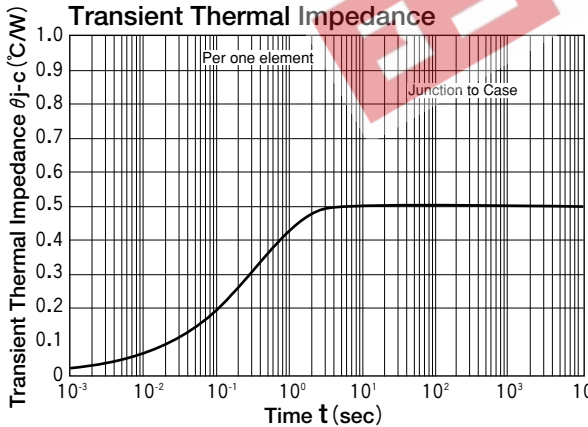
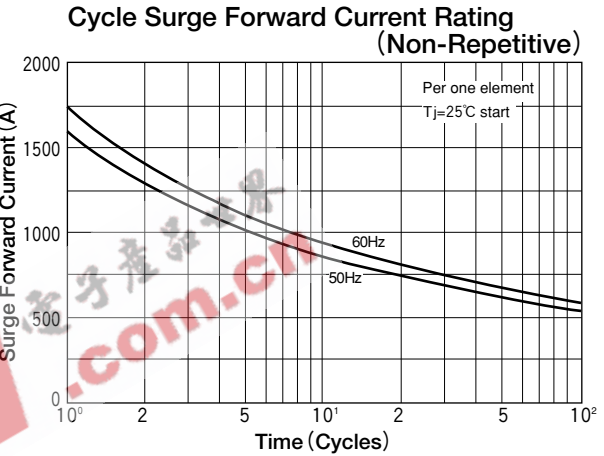
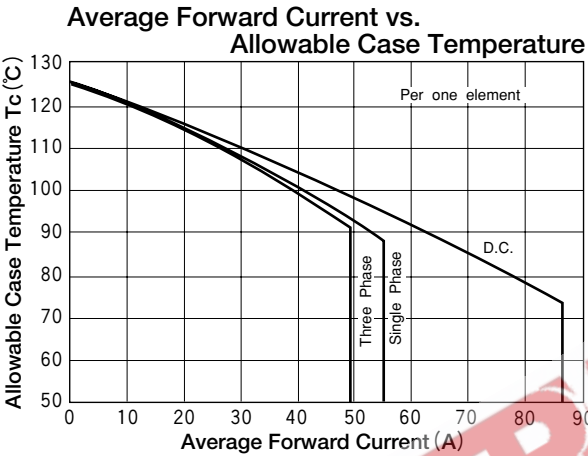
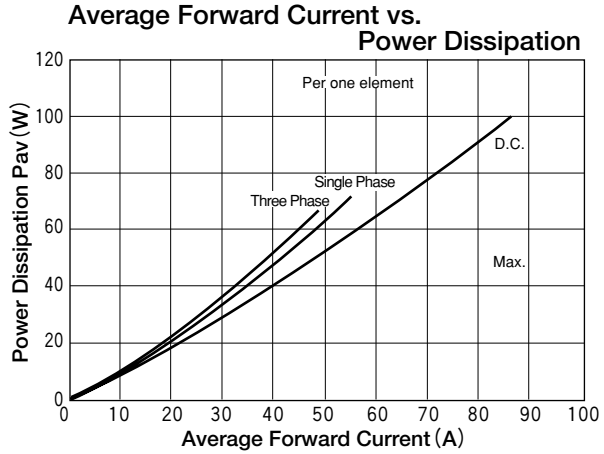
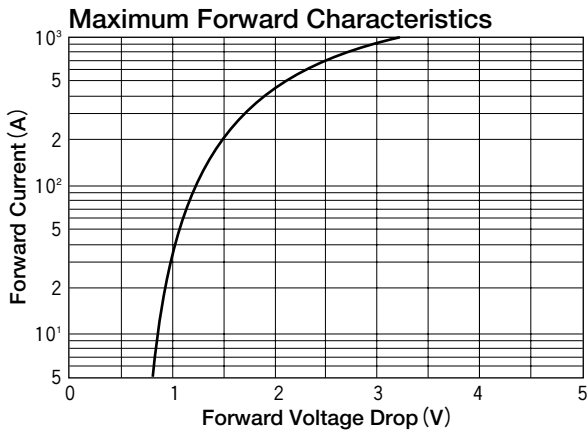

This datasheet has been download from:

[www.datasheetcatalog.com](http://www.datasheetcatalog.com)

Datasheets for electronics components.

EEPW 电子產品世界  
.com.cn