

# DDTC (R1≠R2 SERIES) CA

NPN PRE-BIASED SMALL SIGNAL SOT-23 SURFACE MOUNT TRANSISTOR

NEW PRODUCT

## Features

- Epitaxial Planar Die Construction
- Complementary PNP Types Available (DDTA)
- Built-In Biasing Resistors, R1≠R2

## Mechanical Data

- Case: SOT-23, Molded Plastic
- Case material - UL Flammability Rating 94V-0
- Moisture sensitivity: Level 1 per J-STD-020A
- Terminals: Solderable per MIL-STD-202, Method 208
- Terminal Connections: See Diagram
- Marking: Date Code and Marking Code (See Diagrams & Page 3)
- Weight: 0.008 grams (approx.)
- Ordering Information (See Page 2)

P/N	R1 (NOM)	R2 (NOM)	MARKING
DDTC113ZCA	1KΩ	10KΩ	N02
DDTC123YCA	2.2KΩ	10KΩ	N05
DDTC123JCA	2.2KΩ	47KΩ	N06
DDTC143XCA	4.7KΩ	10KΩ	N09
DDTC143FCA	4.7KΩ	22KΩ	N10
DDTC143ZCA	4.7KΩ	47KΩ	N11
DDTC114YCA	10KΩ	47KΩ	N14
DDTC114WCA	10KΩ	4.7KΩ	N15
DDTC124XCA	22KΩ	47KΩ	N18
DDTC144VCA	47KΩ	10KΩ	N21
DDTC144WCA	47KΩ	22KΩ	N22

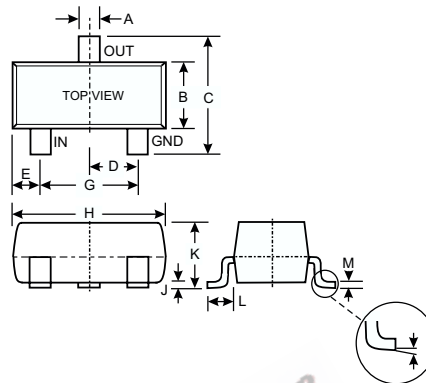

SOT-23		
Dim	Min	Max
A	0.37	0.51
B	1.20	1.40
C	2.30	2.50
D	0.89	1.03
E	0.45	0.60
G	1.78	2.05
H	2.80	3.00
J	0.013	0.10
K	0.903	1.10
L	0.45	0.61
M	0.85	0.80
α	0°	8°

All Dimensions in mm

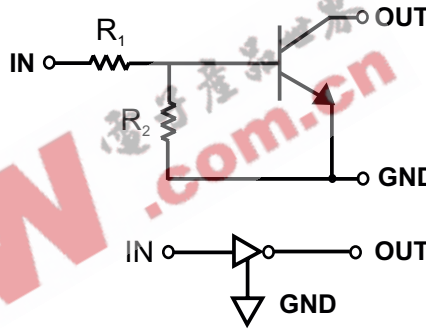

SCHEMATIC DIAGRAM

## Maximum Ratings @ T<sub>A</sub> = 25°C unless otherwise specified

Characteristic	Symbol	Value	Unit
Supply Voltage, (3) to (1)	V <sub>CC</sub>	50	V
Input Voltage, (2) to (1)	V <sub>IN</sub>	DDTC113ZCA: -5 to +10 DDTC123YCA: -5 to +12 DDTC123JCA: -5 to +12 DDTC143XCA: -7 to +20 DDTC143FCA: -6 to +30 DDTC143ZCA: -5 to +30 DDTC114YCA: -6 to +40 DDTC114WCA: -10 to +30 DDTC124XCA: -10 to +40 DDTC144VCA: -15 to +40 DDTC144WCA: -10 to +40	V
Output Current	I <sub>O</sub>	DDTC113ZCA: 100 DDTC123YCA: 100 DDTC123JCA: 100 DDTC143XCA: 100 DDTC143FCA: 100 DDTC143ZCA: 100 DDTC114YCA: 70 DDTC114WCA: 100 DDTC124XCA: 50 DDTC144VCA: 30 DDTC144WCA: 30	mA
Output Current	I <sub>C</sub> (Max)	100	mA
Power Dissipation	P <sub>d</sub>	200	mW
Thermal Resistance, Junction to Ambient Air (Note 1)	R <sub>θJA</sub>	625	°C/W
Operating and Storage and Temperature Range	T <sub>j</sub> , T <sub>STG</sub>	-55 to +150	°C

Note: 1. Mounted on FR4 PC Board with recommended pad layout at <http://www.diodes.com/datasheets/ap02001.pdf>.

**Electrical Characteristics** @ T<sub>A</sub> = 25°C unless otherwise specified

Characteristic		Symbol	Min	Typ	Max	Unit	Test Condition	
Input Voltage	DDTC113ZCA DDTC123YCA DDTC123JCA DDTC143XCA DDTC143FCA DDTC143ZCA DDTC114YCA DDTC114WCA DDTC124XCA DDTC144VCA DDTC144WCA	V <sub>I(off)</sub>	0.3 0.3 0.5 0.3 0.3 0.5 0.3 0.8 0.4 1.0 0.8	—	—	—	V	V <sub>CC</sub> = 5V, I <sub>O</sub> = 100μA
	DDTC113ZCA DDTC123YCA DDTC123JCA DDTC143XCA DDTC143FCA DDTC143ZCA DDTC114YCA DDTC114WCA DDTC124XCA DDTC144VCA DDTC144WCA	V <sub>I(on)</sub>	—	—	3.0 3.0 1.1 2.5 1.3 1.3 1.4 3.0 2.5 5.0 4.0	—	V	V <sub>O</sub> = 0.3V, I <sub>O</sub> = 20mA V <sub>O</sub> = 0.3V, I <sub>O</sub> = 20mA V <sub>O</sub> = 0.3V, I <sub>O</sub> = 5mA V <sub>O</sub> = 0.3V, I <sub>O</sub> = 20mA V <sub>O</sub> = 0.3V, I <sub>O</sub> = 3mA V <sub>O</sub> = 0.3V, I <sub>O</sub> = 5mA V <sub>O</sub> = 0.3V, I <sub>O</sub> = 1mA V <sub>O</sub> = 0.3V, I <sub>O</sub> = 2mA V <sub>O</sub> = 0.3V, I <sub>O</sub> = 2mA V <sub>O</sub> = 0.3V, I <sub>O</sub> = 2mA V <sub>O</sub> = 0.3V, I <sub>O</sub> = 2mA
Output Voltage		V <sub>O(on)</sub>	—	0.1	0.3	V	I <sub>O</sub> /I <sub>I</sub> = 5mA/0.25mA DDCT123JCA I <sub>O</sub> /I <sub>I</sub> = 5mA/0.25mA DDCT143ZCA I <sub>O</sub> /I <sub>I</sub> = 5mA/0.25mA DDCT114YCA I <sub>O</sub> /I <sub>I</sub> = 10mA/0.5mA All Others	
Input Current	DDTC113ZCA DDTC123YCA DDTC123JCA DDTC143XCA DDTC143FCA DDTC143ZCA DDTC114YCA DDTC114WCA DDTC124XCA DDTC144VCA DDTC144WCA	I <sub>I</sub>	—	—	7.2 3.8 3.6 1.8 1.8 1.8 0.88 0.88 0.36 0.16 0.16	mA	V <sub>I</sub> = 5V	
Output Current		I <sub>O(off)</sub>	—	—	0.5	μA	V <sub>CC</sub> = 50V, V <sub>I</sub> = 0V	
DC Current Gain	DDTC113ZCA DDTC123YCA DDTC123JCA DDTC143XCA DDTC143FCA DDTC143ZCA DDTC114YCA DDTC114WCA DDTC124XCA DDTC144VCA DDTC144WCA	G <sub>I</sub>	33 33 80 30 68 80 68 24 68 33 56	—	—	—	V <sub>O</sub> = 5V, I <sub>O</sub> = 10mA	
Input Resistor Tolerance		ΔR <sub>1</sub>	-30	—	+30	%	—	
Resistance Ratio Tolerance		ΔR <sub>2</sub> /R <sub>1</sub>	-20	—	+20	%	—	
Gain-Bandwidth Product*		f <sub>T</sub>	—	250	—	MHz	V <sub>CE</sub> = 10V, I <sub>E</sub> = 5mA, f = 100MHz	

\* Transistor - For Reference Only

**Ordering Information**

Device	Packaging	Shipping
DDTC113ZCA-7	SOT-23	3000/Tape & Reel
DDTC123YCA-7	SOT-23	3000/Tape & Reel
DDTC123JCA-7	SOT-23	3000/Tape & Reel
DDTC143XCA-7	SOT-23	3000/Tape & Reel
DDTC143FCA-7	SOT-23	3000/Tape & Reel
DDTC143ZCA-7	SOT-23	3000/Tape & Reel
DDTC114YCA-7	SOT-23	3000/Tape & Reel
DDTC114WCA-7	SOT-23	3000/Tape & Reel
DDTC124XCA-7	SOT-23	3000/Tape & Reel
DDTC144VCA-7	SOT-23	3000/Tape & Reel
DDTC144WCA-7	SOT-23	3000/Tape & Reel

Notes: 2. For Packaging Details, go to our website at <http://www.diodes.com/datasheets/ap02007.pdf>.

## Marking Information

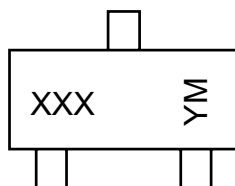

XXX = Product Type Marking Code  
 See Sheet 1 Diagrams  
 YM = Date Code Marking  
 Y = Year ex: N = 2002  
 M = Month ex: 9 = September

### Date Code Key

Year	2002	2003	2004	2005	2006	2007	2008	2009
Code	N	P	R	S	T	U	V	W

Month	Jan	Feb	March	Apr	May	Jun	Jul	Aug	Sep	Oct	Nov	Dec
Code	1	2	3	4	5	6	7	8	9	O	N	D

EEPW 电子产品世界  
 .com.cn

TYPICAL CURVES - DDTC123JCA

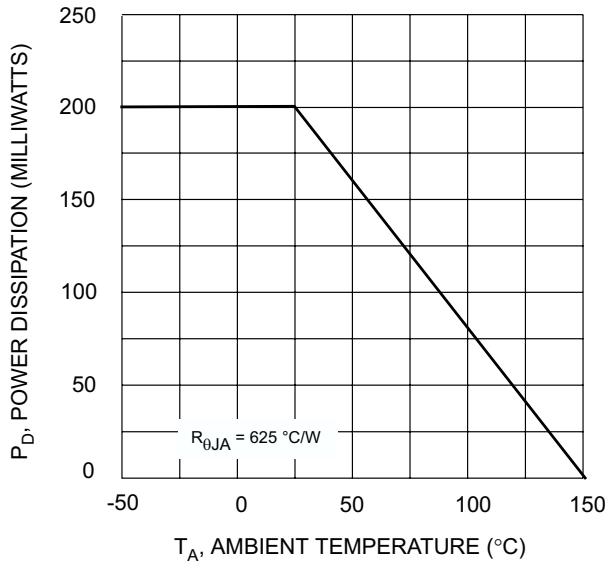

Fig. 1 Derating Curve

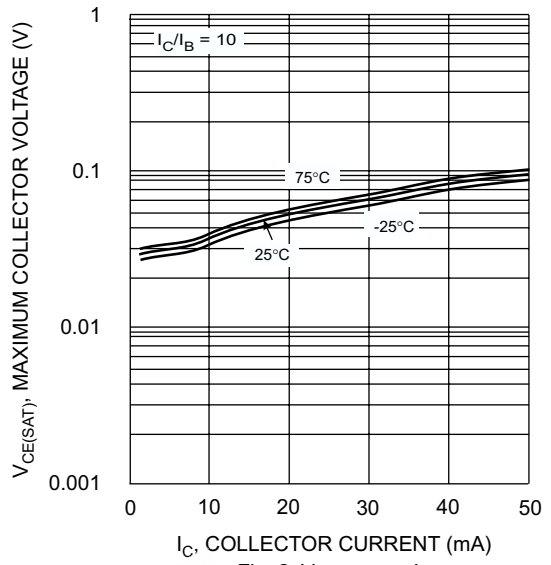

Fig. 2  $V_{CE(SAT)}$  vs.  $I_C$

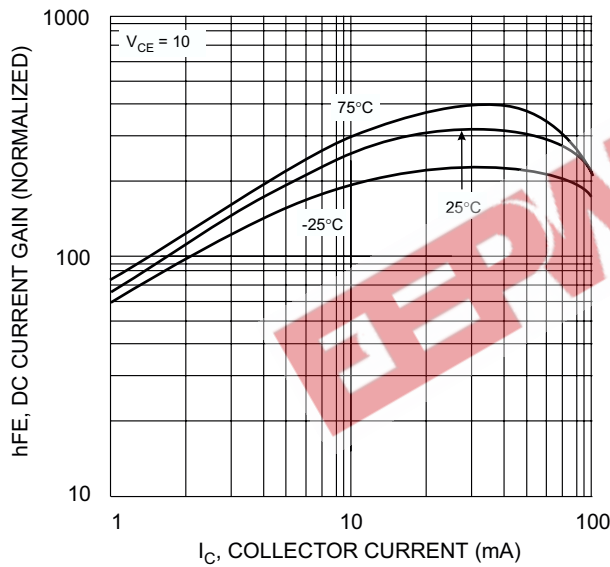

Fig. 3 DC CURRENT GAIN

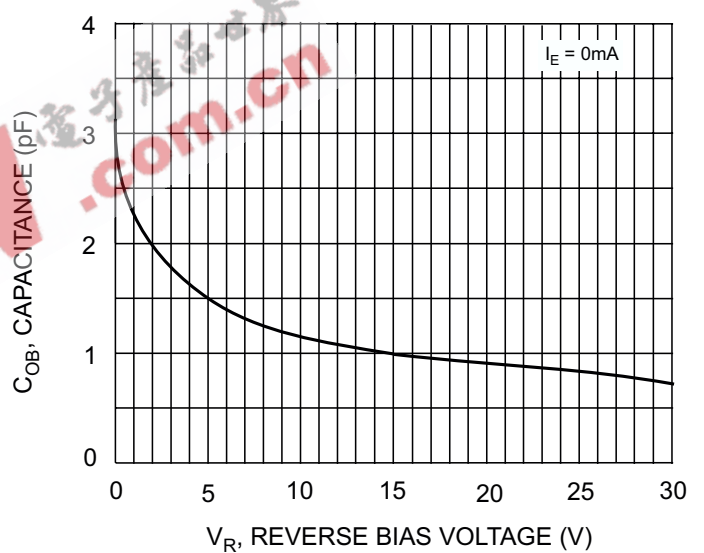

Fig. 4 Output Capacitance

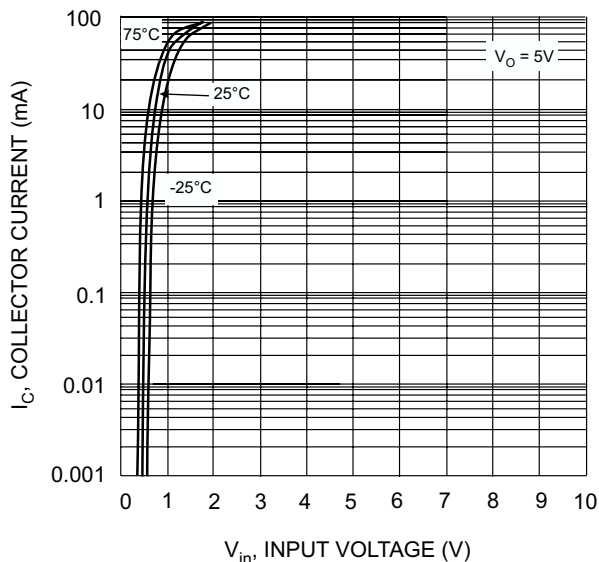

Fig. 5 Collector Current Vs. Input Voltage

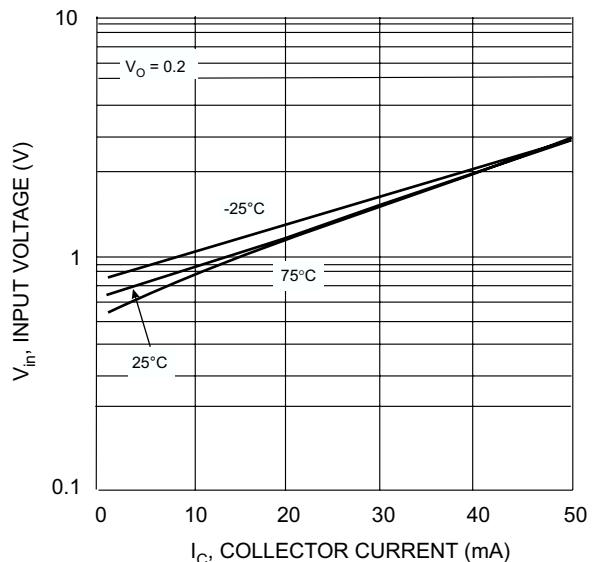

Fig. 6 Input Voltage vs. Collector Current