

Features

- Epitaxial Planar Die Construction
- Complementary PNP Types Available (DDTA)
- Built-In Biasing Resistor, R1 only

Mechanical Data

- Case: SOT-323, Molded Plastic
- Case Material - UL Flammability Rating 94V-0
- Moisture sensitivity: Level 1 per J-STD-020A
- Terminals: Solderable per MIL-STD-202, Method 208
- Terminal Connections: See Diagram
- Marking: Date Code and Marking Code (See Diagrams & Page 2)
- Weight: 0.006 grams (approx.)
- Ordering Information (See Page 2)

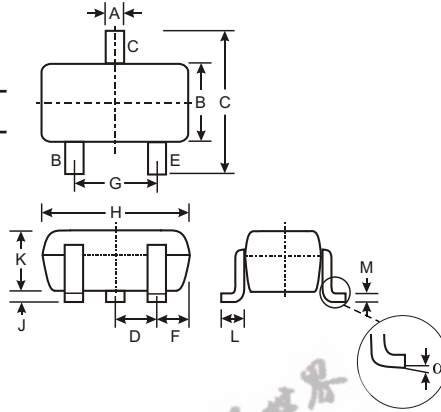

SOT-323		
Dim	Min	Max
A	0.25	0.40
B	1.15	1.35
C	2.00	2.20
D	0.65 Nominal	
E	0.30	0.40
G	1.20	1.40
H	1.80	2.20
J	0.0	0.10
K	0.90	1.00
L	0.25	0.40
M	0.10	0.18
	0	8

All Dimensions in mm

P/N	R1 (NOM)	MARKING
DDTC113TUA	1K	N01
DDTC123TUA	2.2K	N03
DDTC143TUA	4.7K	N07
DDTC114TUA	10K	N12
DDTC124TUA	22K	N16
DDTC144TUA	47K	N19
DDTC115TUA	100K	N23
DDTC125TUA	200K	N25

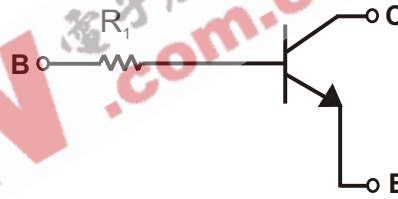

SCHMATIC DIAGRAM

Maximum Ratings @ T_A = 25 C unless otherwise specified

Characteristic	Symbol	Value	Unit
Collector-Base Voltage	V _{CBO}	50	V
Collector-Emitter Voltage	V _{CEO}	50	V
Emitter-Base Voltage	V _{EBO}	5	V
Collector Current	I _C (Max)	100	mA
Power Dissipation	P _d	200	mW
Thermal Resistance, Junction to Ambient Air (Note 1)	R _{JA}	833	C/W
Operating and Storage and Temperature Range	T _J , T _{STG}	-55 to +150	C

Note: 1. Mounted on FR4 PC Board with recommended pad layout at <http://www.diodes.com/datasheets/ap02001.pdf>.

Electrical Characteristics @ $T_A = 25\text{ C}$ unless otherwise specified

Characteristic	Symbol	Min	Typ	Max	Unit	Test Condition
Collector-Base Breakdown Voltage	BV_{CBO}	50			V	$I_C = 50\text{ A}$
Collector-Emitter Breakdown Voltage	BV_{CEO}	50			V	$I_C = 1\text{ mA}$
Emitter-Base Breakdown Voltage	BV_{EBO}	5			V	$I_E = 50\text{ A}$
Collector Cutoff Current	I_{CBO}			0.5	A	$V_{CB} = 50\text{ V}$
Emitter Cutoff Current	I_{EBO}			0.5	A	$V_{EB} = 4\text{ V}$
Collector-Emitter Saturation Voltage	$V_{CE(sat)}$			0.3	V	$I_C/I_B = 10\text{ mA}/1\text{ mA}$ DDTC113TUA $I_C/I_B = 5\text{ mA}/0.5\text{ mA}$ DDTC123TUA $I_C/I_B = 2.5\text{ mA}/.25\text{ mA}$ DDTC143TUA $I_C/I_B = 1\text{ mA}/.1\text{ mA}$ DDTC114TUA $I_C/I_B = 5\text{ mA}/0.5\text{ mA}$ DDTC124TUA $I_C/I_B = 2.5\text{ mA}/.25\text{ mA}$ DDTC144TUA $I_C/I_B = 1\text{ mA}/0.1\text{ mA}$ DDTC115TUA $I_C/I_B = .5\text{ mA}/.05\text{ mA}$ DDTC125TUA
DC Current Transfer Ratio	h_{FE}	100	250	600		$I_C = 1\text{ mA}, V_{CE} = 5\text{ V}$
Input Resistor (R_1) Tolerance	DR_1	-30		+30	%	
Gain-Bandwidth Product*	f_T		250		MHz	$V_{CE} = 10\text{ V}, I_E = -5\text{ mA}, f = 100\text{ MHz}$

* Transistor - For Reference Only

Ordering Information (Note 2)

Device	Packaging	Shipping
DDTC113TUA-7	SOT-323	3000/Tape & Reel
DDTC123TUA-7	SOT-323	3000/Tape & Reel
DDTC143TUA-7	SOT-323	3000/Tape & Reel
DDTC114TUA-7	SOT-323	3000/Tape & Reel
DDTC124TUA-7	SOT-323	3000/Tape & Reel
DDTC144TUA-7	SOT-323	3000/Tape & Reel
DDTC115TUA-7	SOT-323	3000/Tape & Reel
DDTC125TUA-7	SOT-323	3000/Tape & Reel

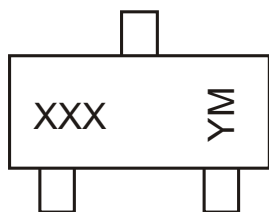
Notes: 2. For Packaging Details, go to our website at <http://www.diodes.com/datasheets/ap02007.pdf>.**Marking Information**

XXX = Product Type Marking Code
 See Sheet 1 Diagrams
 YM = Date Code Marking
 Y = Year ex: N = 2002
 M = Month ex: 9 = September

Date Code Key

Year	2002	2003	2004	2005	2006	2007	2008	2009
Code	N	P	R	S	T	U	V	W

Month	Jan	Feb	March	Apr	May	Jun	Jul	Aug	Sep	Oct	Nov	Dec
Code	1	2	3	4	5	6	7	8	9	O	N	D

TYPICAL CURVES - DDTC114TUA

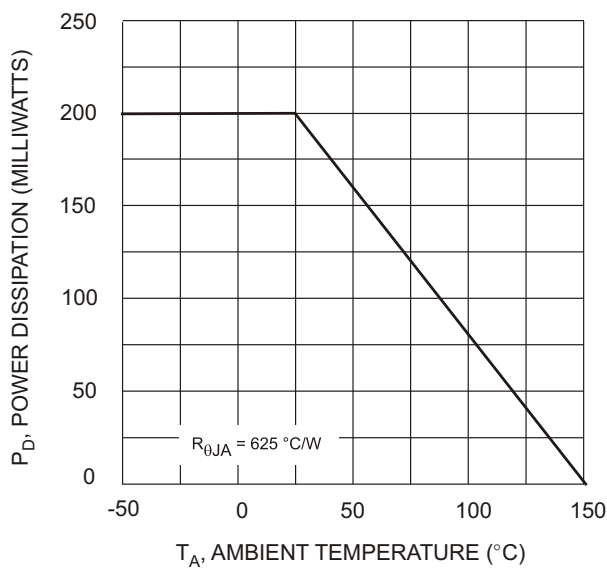

Fig. 1 Derating Curve

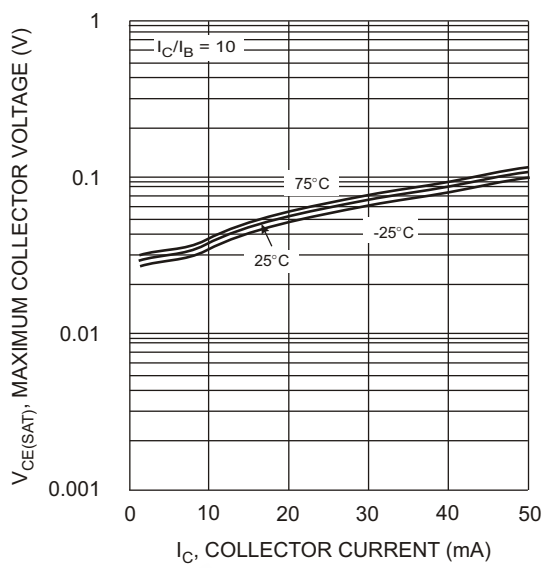

Fig. 2 $V_{CE(SAT)}$ vs. I_C

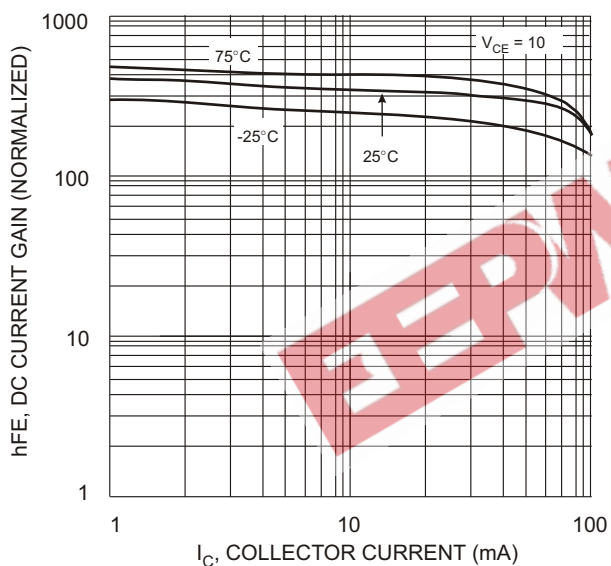

Fig. 3 DC Current Gain

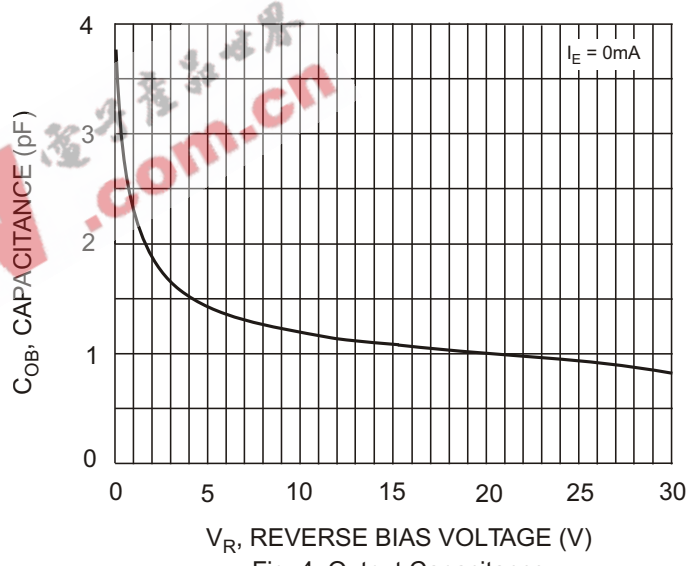

Fig. 4 Output Capacitance

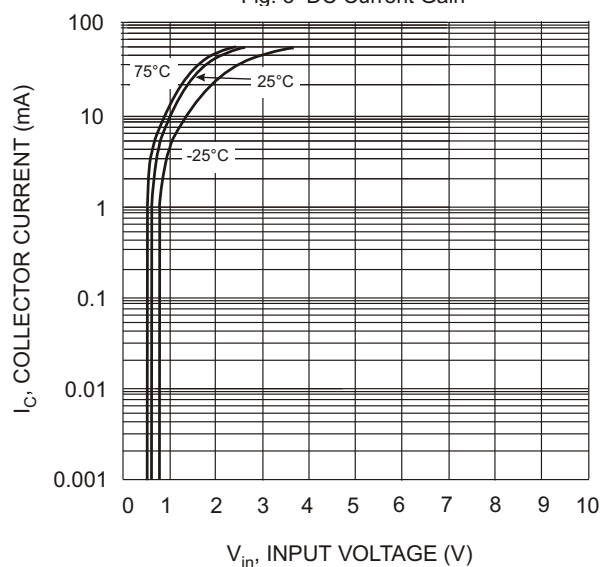

Fig. 5 Collector Current Vs. Input Voltage

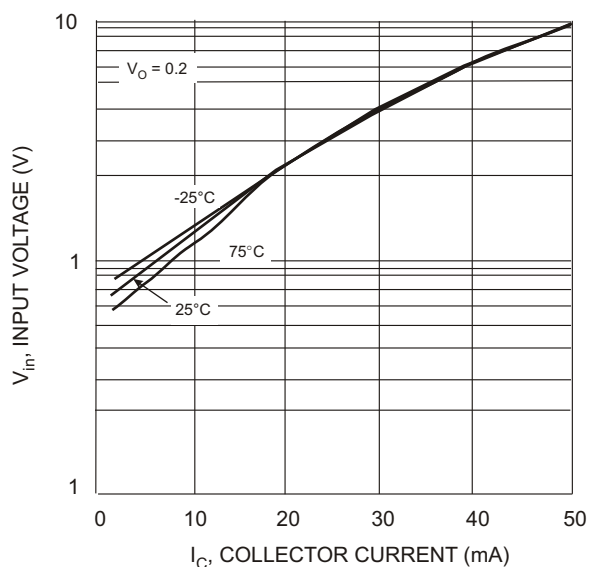

Fig. 6 Input Voltage vs. Collector Current