

# DDTC (R2-ONLY SERIES) E

NPN PRE-BIASED SMALL SIGNAL SOT-523 SURFACE MOUNT TRANSISTOR

NEW PRODUCT

## Features

- Epitaxial Planar Die Construction
- Complementary PNP Types Available (DDTA)
- Built-In Biasing Resistor, R2 only

## Mechanical Data

- Case: SOT-523, Molded Plastic
- Case material - UL Flammability Rating 94V-0
- Moisture sensitivity: Level 1 per J-STD-020A
- Terminals: Solderable per MIL-STD-202, Method 208
- Terminal Connections: See Diagram
- Marking: Date Code and Marking Code (See Diagrams & Page 2)
- Weight: 0.002 grams (approx.)
- Ordering Information (See Page 2)

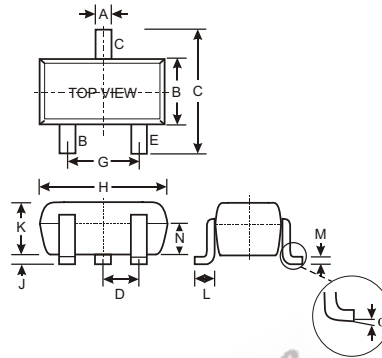

SOT-523			
Dim	Min	Max	Typ
A	0.15	0.30	0.22
B	0.75	0.85	0.80
C	1.45	1.75	1.60
D	—	—	0.50
G	0.90	1.10	1.00
H	1.50	1.70	1.60
J	0.00	0.10	0.05
K	0.60	0.80	0.75
L	0.10	0.30	0.22
M	0.10	0.20	0.12
N	0.45	0.65	0.50
$\alpha$	0°	8°	—
All Dimensions in mm			

P/N	R2 (NOM)	MARKING
DDTC114GE	10K $\Omega$	N26
DDTC124GE	22K $\Omega$	N27
DDTC144GE	47K $\Omega$	N28
DDTC115GE	100K $\Omega$	N29

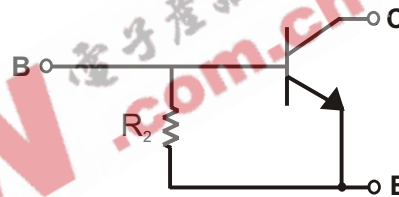

SCHMATIC DIAGRAM

## Maximum Ratings @ T<sub>A</sub> = 25°C unless otherwise specified

Characteristic	Symbol	Value	Unit
Collector-Base Voltage	V <sub>CBO</sub>	50	V
Collector-Emitter Voltage	V <sub>CEO</sub>	50	V
Emitter-Base Voltage	V <sub>EBO</sub>	5	V
Collector Current	I <sub>C</sub> (Max)	100	mA
Power Dissipation	P <sub>d</sub>	150	mW
Thermal Resistance, Junction to Ambient Air (Note 1)	R <sub>θJA</sub>	833	°C/W
Operating and Storage and Temperature Range	T <sub>J</sub> , T <sub>STG</sub>	-55 to +150	°C

Note: 1. Mounted on FR4 PC Board with recommended pad layout, which can be found on our website at <http://www.diodes.com/datasheets/ap02001.pdf>.

**Electrical Characteristics** @  $T_A = 25^\circ\text{C}$  unless otherwise specified

Characteristic		Symbol	Min	Typ	Max	Unit	Test Condition
Collector-Base Breakdown Voltage		$BV_{CBO}$	50	—	—	V	$I_C = 50\mu\text{A}$
Collector-Emitter Breakdown Voltage		$BV_{CEO}$	50	—	—	V	$I_C = 1\text{mA}$
Emitter-Base Breakdown Voltage		$BV_{EBO}$	5	—	—	V	$I_E = 720\mu\text{A}$ , DDTC114GE $I_E = 330\mu\text{A}$ , DDTC124GE $I_E = 160\mu\text{A}$ , DDTC144GE $I_E = 72\mu\text{A}$ , DDTC115GE
Collector Cutoff Current		$I_{CBO}$	—	—	0.5	$\mu\text{A}$	$V_{CB} = 50\text{V}$
Emitter Cutoff Current	DDTC114GE	$I_{EBO}$	300	—	580	$\mu\text{A}$	$V_{EB} = 4\text{V}$
	DDTC124GE		140		260		
	DDTC144GE		65		130		
	DDTC115GE		30		58		
Collector-Emitter Saturation Voltage		$V_{CE(sat)}$	—	—	0.3	V	$I_C = 10\text{mA}$ , $I_B = 0.5\text{mA}$
DC Current Transfer Ratio	DDTC114GE	$h_{FE}$	30	—	—	—	$I_C = 5\text{mA}$ , $V_{CE} = 5\text{V}$
	DDTC124GE		56				
	DDTC144GE		68				
	DDTC115GE		82				
Bleeder Resistor ( $R_2$ ) Tolerance		$DR_2$	-30	—	+30	%	—
Gain-Bandwidth Product*		$f_T$	—	250	—	MHz	$V_{CE} = 10\text{V}$ , $I_E = -5\text{mA}$ , $f = 100\text{MHz}$

\* Transistor - For Reference Only

**Ordering Information** (Note 2)

Device	Packaging	Shipping
DDTC114GE-7	SOT-523	3000/Tape & Reel
DDTC124GE-7	SOT-523	3000/Tape & Reel
DDTC144GE-7	SOT-523	3000/Tape & Reel
DDTC115GE-7	SOT-523	3000/Tape & Reel

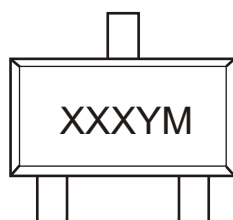
Notes: 2. For Packaging Details, go to our website at <http://www.diodes.com/datasheets/ap02007.pdf>.**Marking Information**

XXX = Product Type Marking Code (See Page 1, e.g. N26 = DDTC114GE)  
 YM = Date Code Marking  
 Y = Year (ex: N = 2002)  
 M = Month (ex: 9 = September)

## Date Code Key

Year	2002	2003	2004	2005	2006	2007	2008	2009
Code	N	P	R	S	T	U	V	W

Month	Jan	Feb	March	Apr	May	Jun	Jul	Aug	Sep	Oct	Nov	Dec
Code	1	2	3	4	5	6	7	8	9	O	N	D

TYPICAL CURVES - DDTC114GE

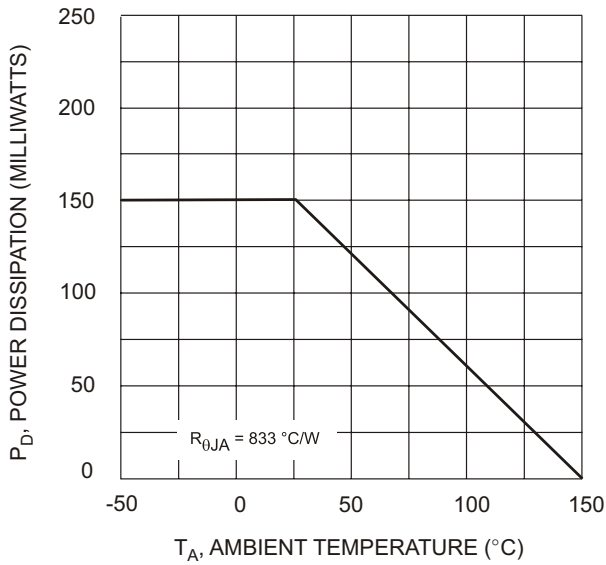

Fig. 1 Derating Curve

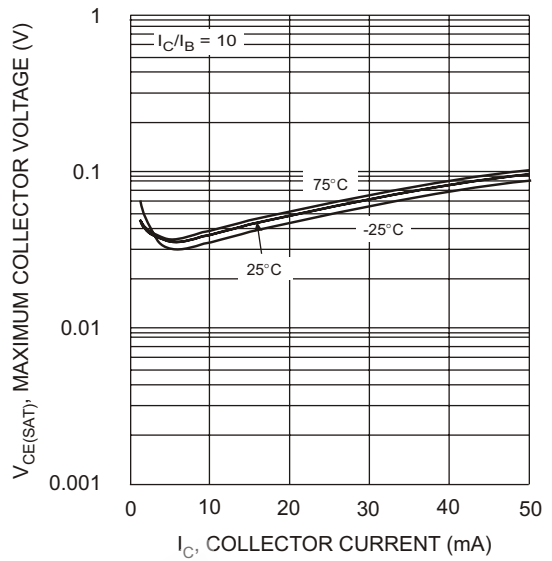

Fig. 2  $V_{CE(SAT)}$  vs.  $I_C$

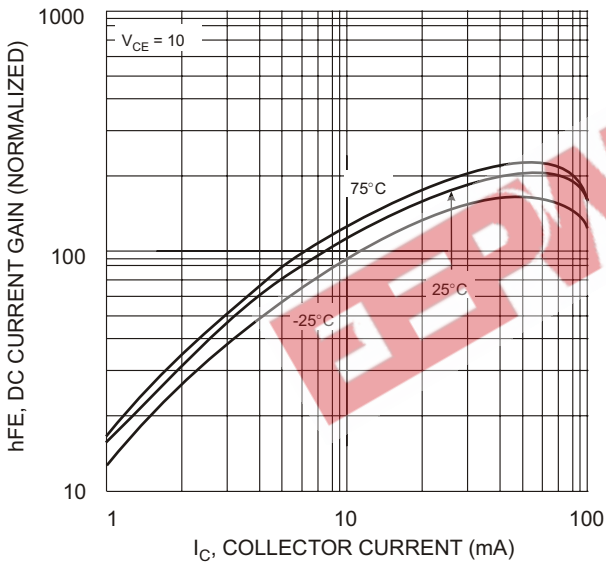

Fig. 3 DC CURRENT GAIN

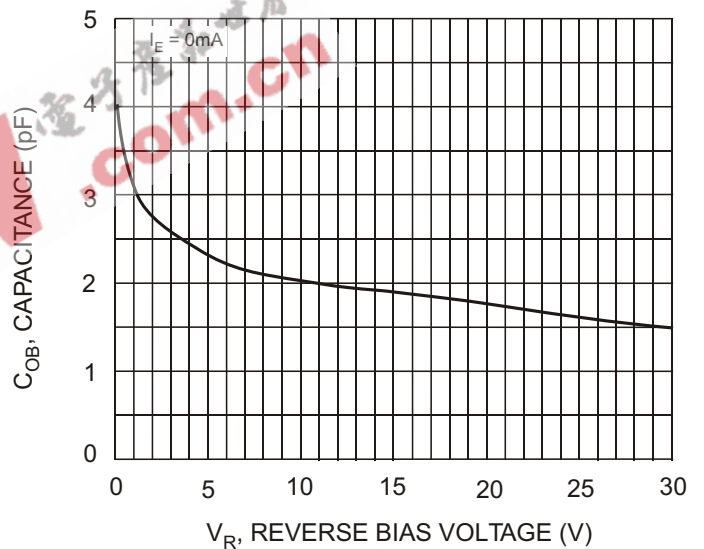

Fig. 4 Output Capacitance

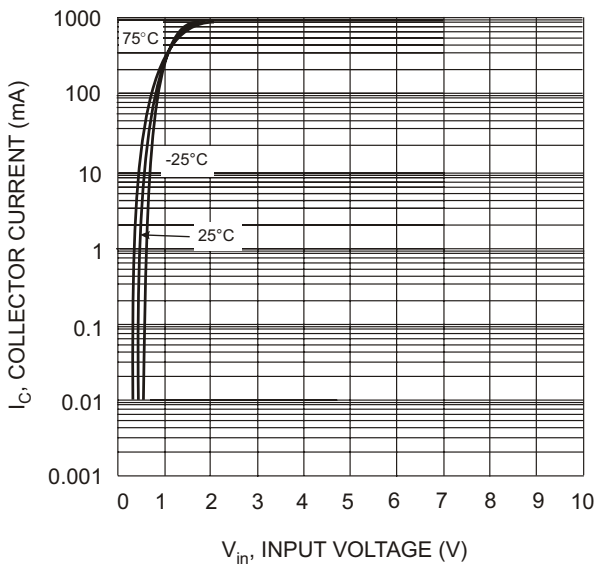

Fig. 5 Collector Current Vs. Input Voltage

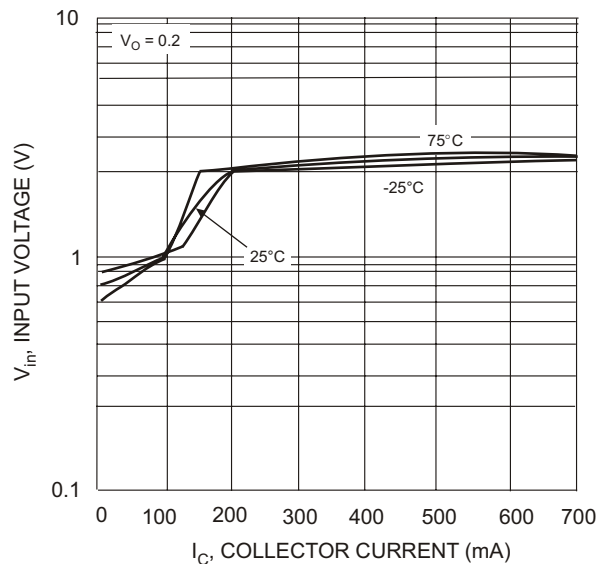

Fig. 6 Input Voltage vs. Collector Current