



M.S.KENNEDY CORP.

6W DUAL DC-DC CONVERTERS

DAC2800D SERIES

4707 Dey Road Liverpool, N.Y. 13088

(315) 701-6751

HI-REL DESIGN

- WAVE SOLDERABLE PACKAGE
- ALL CERAMIC CAPACITORS
- SURFACE MOUNT MAGNETICS

FEATURES — DUAL OUTPUT

- REPLACES APEX DHC2812D & DHC2815D
- BOTH OUTPUTS FULLY REGULATED
- NO DERATING — -55°C TO +125°C
- HIGH ISOLATION — 500V
- TRACKING OUTPUT V ADJUSTMENT — STANDARD
- REMOTE SHUTDOWN
- 11 TO 50V INPUT WITH 5 WATT OUTPUT
- AVAILABLE WITH ±12V OR ±15V OUTPUTS

DESCRIPTION

The DAC2800D series of DC-DC converters provides the ruggedness reliability and features required to meet the advanced design challenges of today's hi-rel market. This has been accomplished while retaining a power density of 15 W/in³ and 375 mW/gram of power/package performance. The use of advanced substrate and reflow soldering techniques during construction results in a rugged, cost-effective, and completely solderable package.

The DAC2800D hybrid converter series utilizes all ceramic capacitors, surface mount magnetics, and ultrasonically bonded wires to provide reliable operation at all operating temperatures while surviving G forces of up to 500 G.

The DAC2800D series has two fully regulated tracking outputs. Standard features include output fault monitoring and/or turn on voltage point programming via the shutdown pin. All three functions may be implemented simultaneously with a minimum of external components. An output voltage adjustment / load compensation pin which adjusts both outputs simultaneously is also standard.

Fault tolerant design protects these converters from most external circuit faults. The + output and output adjust pins will withstand + 25 V while the shutdown pin will withstand + 50 V, protecting the converters from a variety of system or board faults e.g. solder bridges etc. Unique load fault protection circuitry allows this converter to pull up loads having difficult static load line characteristics and allows short term load excursions significantly beyond ratings in most applications.

A transformer isolated flyback converter topology operating at a switching frequency of 400 kHz allows operation over a wide input voltage range. Internal filtering of outputs eliminates the need for external capacitors in many applications.

The 8-pin DIP package is hermetically sealed and isolated from the internal circuits. Heat sinking is recommended for full power operation at elevated ambient temperatures.

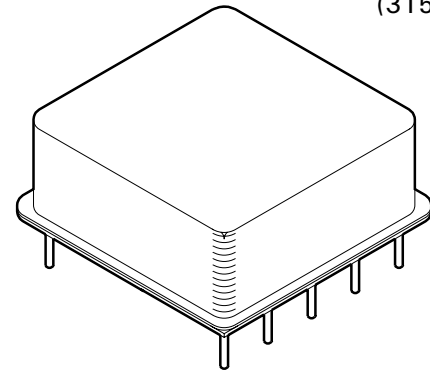

TYPICAL APPLICATION

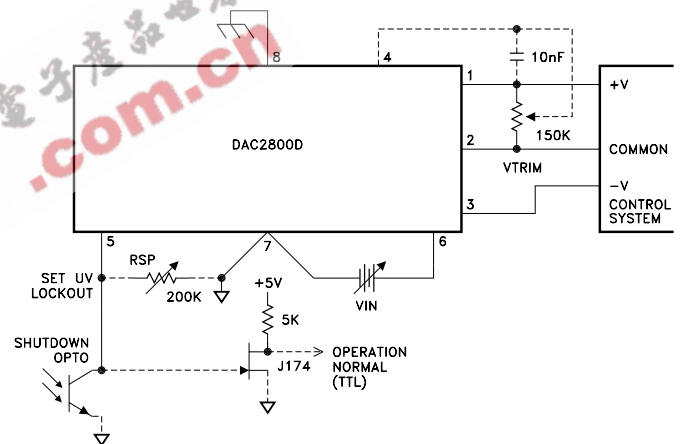

BLOCK DIAGRAM

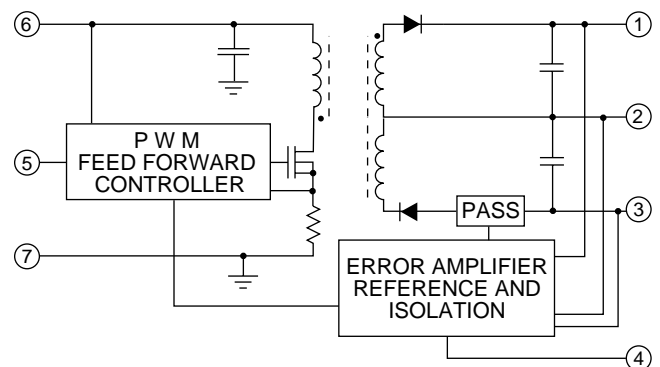

EXTERNAL CONNECTIONS

- | | |
|-----------------|----------|
| 1 + OUTPUT | 8 CASE |
| 2 OUTPUT COMMON | 7 -INPUT |
| 3 -OUTPUT | 6 +INPUT |
| 4 ADJUST/COMP | |
| 5 SHUTDOWN PLUS | |

DAC2812D • DAC2815D

ABSOLUTE MAXIMUM RATINGS SPECIFICATIONS

ABSOLUTE MAXIMUM RATINGS	INPUT VOLTAGE RANGE (Pin 7 to 6 or 5)	DAC2812D	DAC2815D
	INPUT TRANSIENT (Pin 7 to 6)	50Vdc	50Vdc
	OUTPUT CURRENT (Continuous)	80V @ 50ms	80V @ 50ms
	TEMPERATURE, Storage	360mA ⁴	288mA ⁴
	TEMPERATURE, Pin Soldering 10s	-65°C, 150°C	-65°C, 150°C
		300°C	300°C

SPECIFICATIONS

PARAMETER	TEST CONDITIONS ¹	DAC2812D			DAC2815D			UNITS
		MIN	TYP	MAX	MIN	TYP	MAX	
STEADY STATE CHARACTERISTICS								
INPUT VOLTAGE RANGE	-55°C ↔ 125°C	11	28	50	11	28	50	Vdc
OUTPUT VOLTAGE (+/-)	+I _o = -I _o = 10%	11.9	12	12.1	14.9	15	15.1	Vdc
OUTPUT CURRENT -55°C × 125°C	V _{IN} = 16 ↔ 40		±225	360 ⁴		±180	288 ⁴	mAdc
	V _{IN} = 11 ↔ 50		±208	333 ⁴		±167	267 ⁴	mAdc
OUTPUT POWER -55°C × 125°C	V _{IN} = 16 ↔ 40			5.4			5.4	W
	V _{IN} = 11 ↔ 50			5			5	W
EFFICIENCY	+I _o = -I _o = 100%	60	64		61	65		%
LINE REGULATION	V _{IN} = 11 ↔ 50; +I _o = -I _o = 100%		5			5		mV
LOAD REGULATION			5			5		mV
+ (+I _o = 0 - 160%)	-I _o = 40% ²		5			5		mV
- (-I _o = 0 - 160%)	+I _o = 40% ²		20			15		mV
OPERATING TEMPERATURE, CASE TEMPERATURE COEFFICIENT (V _{out} +/-)		-55		125	-55		125	°C
INPUT RIPPLE CURRENT			0.006			0.006		%/°C
WITH 1μH SERIES INDUCTANCE	Bandwidth = 10kHz → 1MHz		340			340		mArms
OUTPUT RIPPLE VOLTAGE	Bandwidth = 10kHz → 1MHz		45			45		mArms
LOAD CAPACITANCE ³ (PER OUTPUT OVER -55°C × 125°C)	Bandwidth = 10kHz → 1MHz		15	60		15	60	mVrms
SHORT CIRCUIT DISSIPATION	V _{IN} = 16 ↔ 40			100			100	μF
QUIESCENT INPUT CURRENT INHIBITED	V _{IN} = 11 ↔ 50			50			50	μF
			0.5			0.5		W
			50	70		50	70	mA
		0.9	1.25	2.5	0.09	1.25	2.5	mA
ISOLATION CHARACTERISTICS (INPUT/OUTPUT/CASE)								
LEAKAGE RESISTANCE	500 Vdc	100			100			MΩ
LEAKAGE CAPACITANCE	10kHz		400	500		400	500	pF
DYNAMIC CHARACTERISTICS								
LINE STEP RESPONSE	V _{IN} = 16 ↔ 40 Vdc							
VOLTAGE CHANGE			200			200		mV
RECOVERY TIME (99%)			250			250		μS
WITH 50 μF OUTPUT CAPACITORS ³								
VOLTAGE CHANGE			150			150		mV
RECOVERY TIME (99%)			400			400		μS
LOAD STEP RESPONSE	+I _o = -I _o = 50 ↔ 100%							
VOLTAGE CHANGE			400			400		mV
RECOVERY TIME (99%)			200			200		μS
WITH 50 μF OUTPUT CAPACITORS ³								
VOLTAGE CHANGE			300			300		mV
RECOVERY TIME (99%)			300			300		μS
START-UP OVERSHOOT	V _{IN} = 0 → 28 Vdc		0			0		mV
SHUTDOWN DELAY	Pin 5 = > 10 ↔ < 8 Vdc		250	500		250	500	μS
SHUTDOWN RECOVERY	Pin 5 = > 8 ↔ < 10 Vdc		40	60		40	60	mS

ABSOLUTE MAXIMUM RATINGS
SPECIFICATIONS

DAC2812D • DAC2815D

- NOTES: 1. Unless otherwise stated $T_C = 25^\circ$, $V_{IN} = 28V$, $-I_o = +I_o = 100\%$,
2. Regulation measured on output pins 1/16" from case. $I_o = 100\%$ means 2.5 or 2.7 watts.
3. Capacitors should be connected from + to common and - to common only.
Capacitance value imbalance should not be more than 4:1.
4. Up to 80% of total load may be drawn from either output.

PACKAGE & THERMAL SPECIFICATIONS

	MIN	TYP	MAX	UNITS
WEIGHT		14		GRAMS
TEMPERATURE RISE, junction to case		17	25	$^\circ C$
TEMPERATURE RISE, ambient		30		$^\circ C/W$

EEPW 电子产品世界
.com.cn

EFFICIENCY CONTOURS

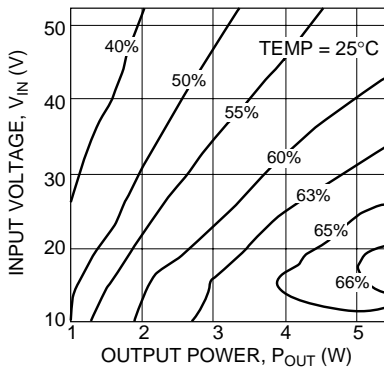

EFFICIENCY CONTOURS

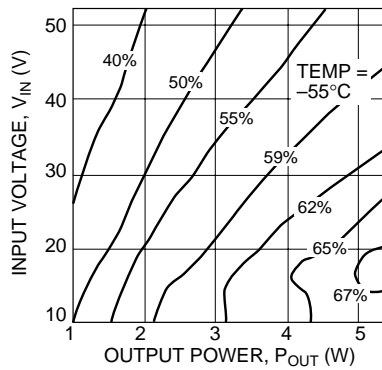

EFFICIENCY CONTOURS

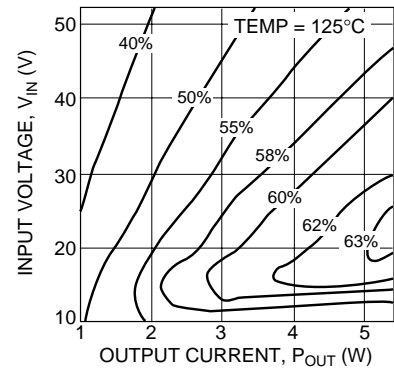

LOW LINE DROP OUT

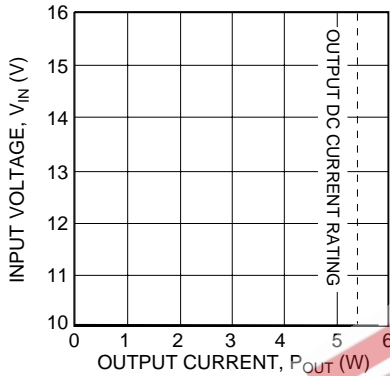

+ LOAD TRANSIENT RESPONSE

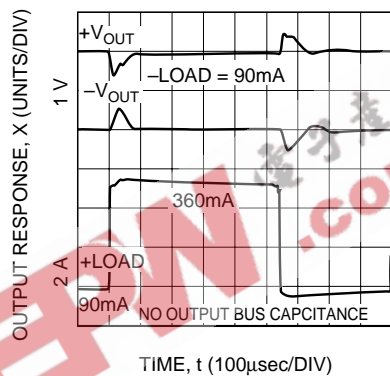

- LOAD TRANSIENT RESPONSE

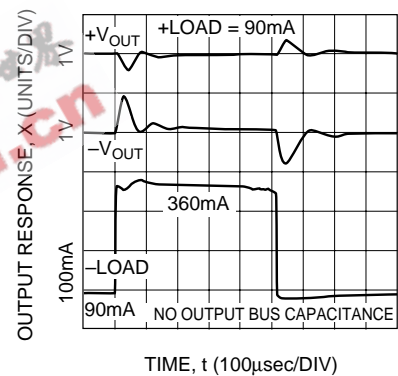

TURN ON THRESHOLD

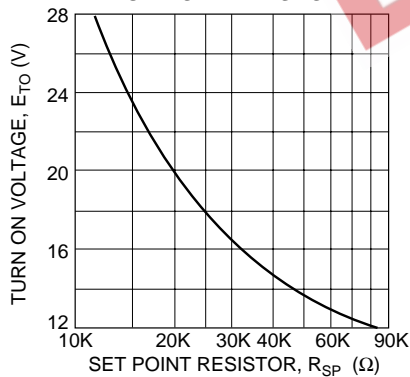

LINE TRANSIENT RESPONSE

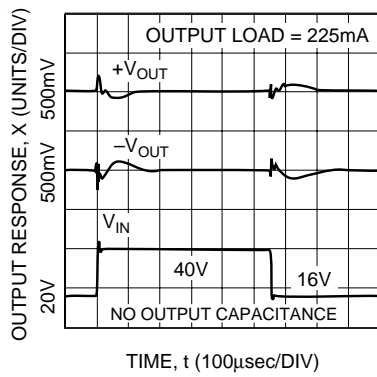

TURN ON RESPONSE

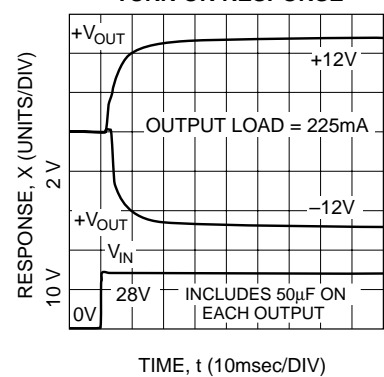

AUDIO REJECTION

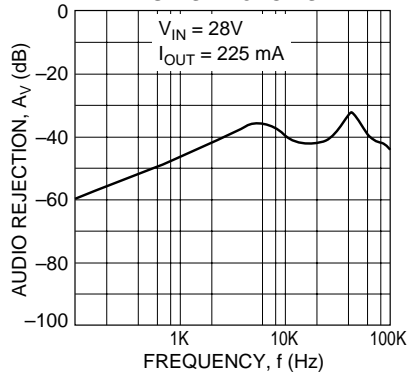

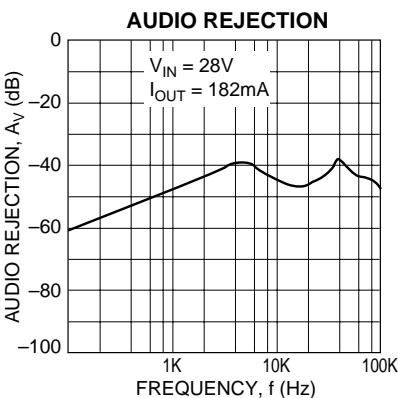
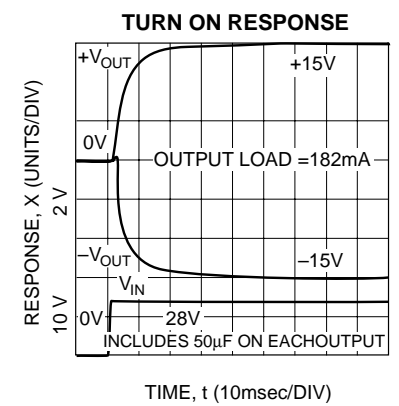
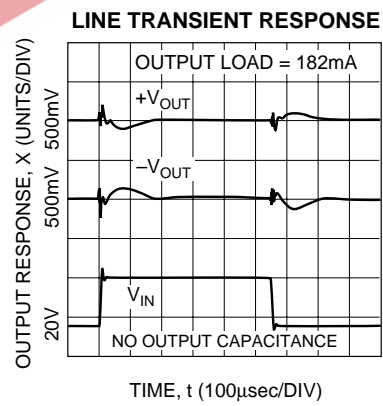
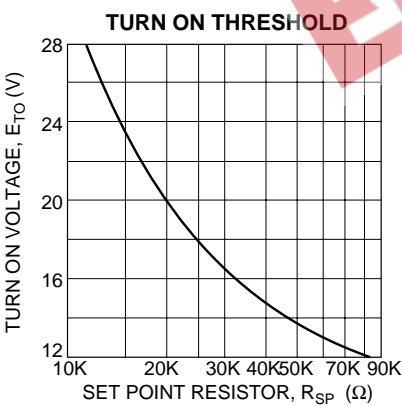
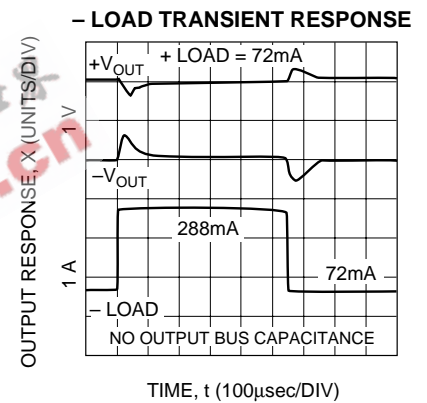
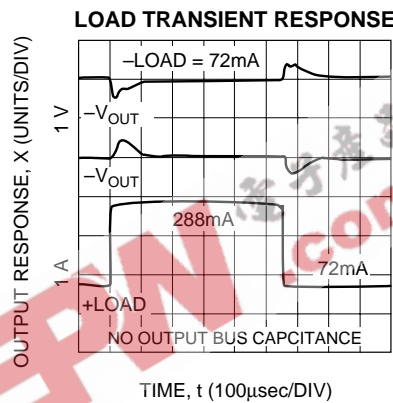
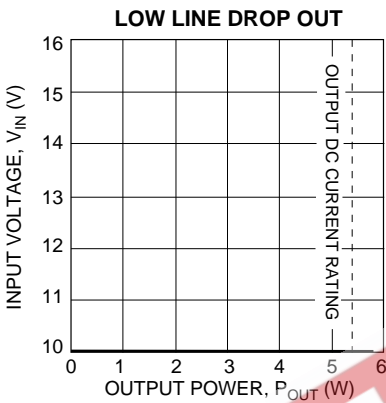
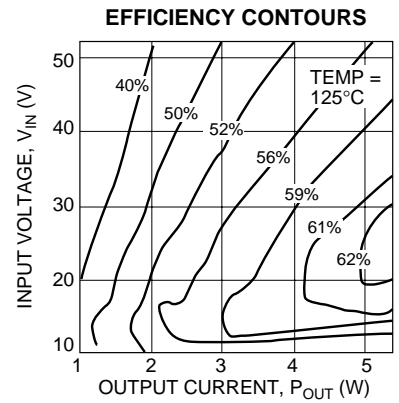
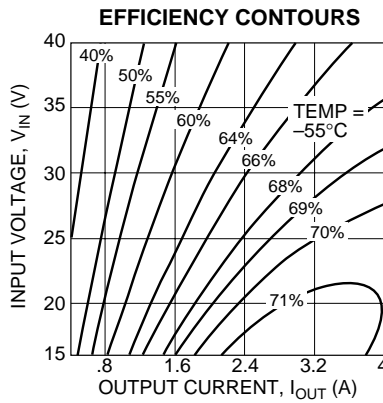
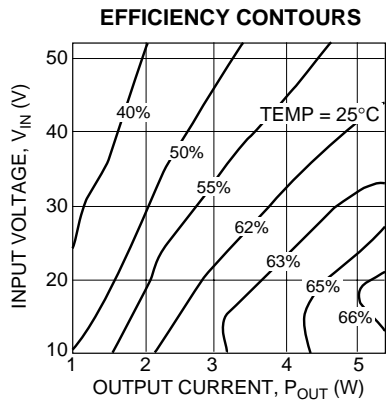

OUTPUT ADJUST / COMP

The output voltage of the DAC2800D may be adjusted from 90% to 110% of nominal value by the use of a 150K potentiometer as shown. Adjustment beyond this range is possible, however certain characteristics of the converter such as but not limited to input voltage range, efficiency, ripple and temperature performance will change. Characterization by the user is recommended in such applications.

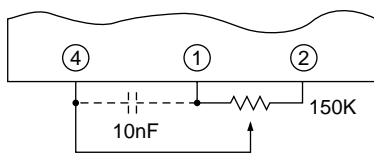

Adjust/comp (pin 4) may be driven by external circuitry referenced to pin 2 (-output) if desired. Grounding pin 4 causes voltage to increase (25% typically) while driving pin 4 above 1.3 V causes output voltage to decrease. Pin 4 may be driven negative without damage, however the resultant increase in converter output voltage should be considered. Pin 4 may be driven through 10K (or more if connection of the comp function is also required).

The comp function of pin 4 allows load transient response to be tailored to suit specific application requirements. This feature may be utilized by connecting a 10nF or less capacitor between pins 4 and 1.

SHUTDOWN PLUS

Pin 5 is used for remote shutdown, output fault detection, and/or setting the input voltage point at which the converter will turn on as shown in the typical application diagram. No connection to pin 5 is necessary for normal operation of the converter. Pin 5 is referenced to pin 7 (-input).

Shutdown may be implemented by simply connecting pin 5 to an open collector logic output or switch rated at 2.5 mA, 25 Vdc or higher.

Input voltage turn on point is programmed with a single resistor from pin 5 to 7. An input turn on/off hysteresis (typically 3.5% of V_{in}) will be observed. This should be considered when making or verifying set point adjustment. The value of the setpoint resistor may be determined by the following:

$$R = \frac{210 * 10^3}{E_{TO} - 9.5} \quad (+/- 10\% \text{ accuracy at } 25^{\circ}\text{C})$$

Set point temperature coefficient is typically + 400ppm/ $^{\circ}\text{C}$

Output fault monitoring is accomplished by observing pin 5 with a high impedance monitoring circuit. Pin 5 voltage drops from over 10 V to below 1 V when a load fault causes the converter's fault protection circuitry to activate. It will remain

low for at least 100 mS and return high. If the load fault is still present pin 5 will return low and the cycle will repeat. A resistor > 400K (from pin 5 to 7 provides pull down for pin 5 if there is no input setpoint programming resistor already in place.

LOAD FAULT RESPONSE

The DAC2800D series of DC-DC converters share load fault philosophies. Load fault conditions include short-circuit and severe overload conditions. The DAC2800D converter series responds to load faults by turning off all power conversion circuits for 250 mS and then attempting to restart for 10 mS (typical). The net "on" duty factor during a fault is very low resulting in low converter dissipation and immunity from overheating at 125 $^{\circ}\text{C}$. Current beyond rated can flow into the load at startup time. This allows the converter to bring up capacitive and other difficult load types more reliably than competing converters.

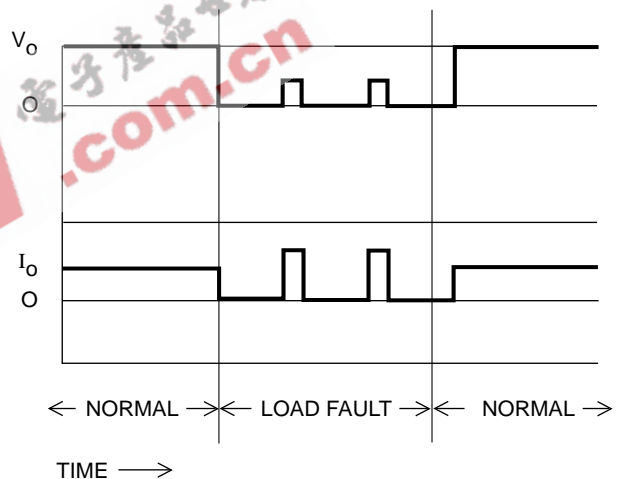

MECHANICAL SPECIFICATIONS

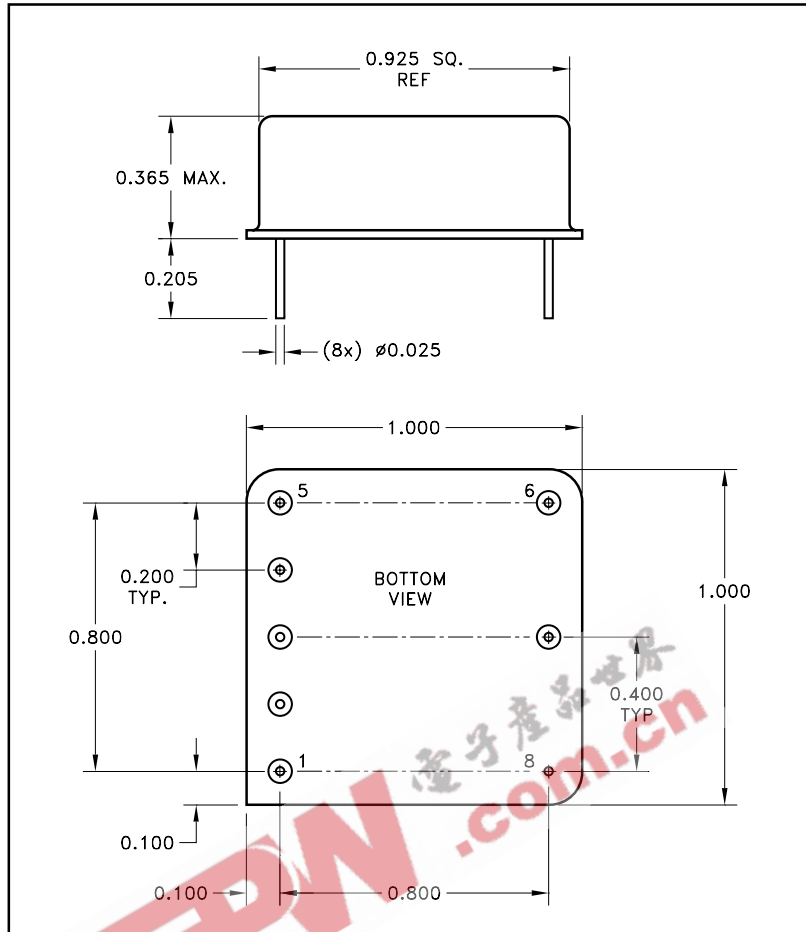

NOTE: ALL DIMENSIONS ARE ± 0.010 INCHES UNLESS OTHERWISE LABELED.
ESD Triangle indicates Pin 1.

ORDERING INFORMATION

DAC2812D

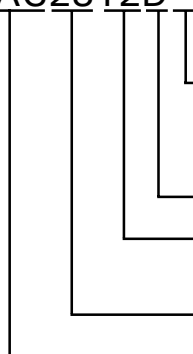

SCREENING

BLANK = INDUSTRIAL; E = EXTENDED RELIABILITY;
H = CLASS H

DUAL OUTPUT

OUTPUT VOLTAGE

12 = $\pm 12V$; 15 = $\pm 15V$

NOMINAL INPUT VOLTAGE

GENERAL PART NUMBER

The above example is an industrial grade $\pm 12V$ dual output converter

M.S. Kennedy Corp.
4707 Dey Road, Liverpool, New York 13088
Phone (315) 701-6751
FAX (315) 701-6752
www.mskennedy.com

The information contained herein is believed to be accurate at the time of printing. MSK reserves the right to make changes to its products or specifications without notice, however, and assumes no liability for the use of its products. Please visit our website for the most recent revision of this datasheet.