

MOS DIGITAL INTEGRATED CIRCUIT

μ PD1703C-013

PHASE LOCKED LOOP FREQUENCY SYNTHESIZER FM/AM DIGITAL TUNING SYSTEM CONTROLLER CMOS LSI

The μ PD1703C-013 is a single chip CMOS controller designed for using as a Phase Locked Loop Frequency Synthesizer Digital Tuning System Controller.

The μ PD1703C-013 is packaged in a 28 pin slim dual in-line package (DIP).

FEATURES

- Fluorescent indicator panel driver incorporated. (segment outputs)
- PLL, swallow counter and system controller are realized in a single chip.
- FM and AM bands ----- Japan and U.S. bands.
- High reference frequency. (FM: 25 kHz, AM: 9/10 kHz)
It results in a high carrier to noise ratio.
- External programmable IF offset for FM band.
- High speed and low power consumption due to CMOS.
- Stand-by mode ----- supply current $I_{DD} = 0.5$ mA (TYP.)
- Display brightness control (DIMMER) ----- Duty ratio 1 : 4
- Internal display decoder for 3.5 digit multiplexed display.
- Automatic power-on clear without any external components.

FUNCTION OF RADIO

- Automatic up search (SEEK)
- Automatic audition (SCAN)
- Manual up or down search
- Preset station memory call
- Preset station memory ----- FM: 6 stations, AM: 6 stations
- Last tuned station memory ----- FM: 1 station, AM: 1 station

FUNCTION OF CLOCK

- 12 hour display format ----- hours, minutes, AM/PM, colon
- Leading-zero blanking
- Hours and minutes set controls
- Minutes and seconds reset control

PACKAGE DIMENSIONS

in millimeters

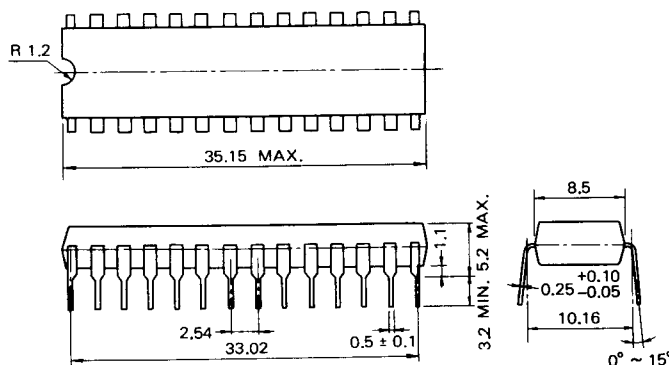

NEC cannot assume any responsibility for any circuits shown or represent that they are free from patent infringement.

NEC reserves the right to make changes at any time without notice in order to improve design and supply

Nippon Electric Co., Ltd.

ABSOLUTE MAXIMUM RATINGS

Supply Voltage	V _{DD}	-0.3 to +6.0	V
Input Voltage	V _I	-0.3 to V _{DD}	V
Output Voltage	V _O	-0.3 to V _{DD}	V
Output Breakdown Voltage *	V _{BDS}	-35	V
Output Current	I _{OH}	-10	mA
Storage Temperature	T _{stg}	-55 to +125	°C
Operating Temperature	T _{opt}	-35 to +75	°C

* : Segment Output Terminals (P-ch open drain)

ELECTRICAL CHARACTERISTICS (T_a= -35 to 75 °C, V_{DD}= 4.5 to 5.5 V)

CHARACTERISTIC	SYMBOL	MIN.	TYP.	MAX.	UNIT	TEST CONDITIONS
High Level Input Voltage	V _{IH1}	0.8V _{DD}		V _{DD}	V	SD terminal
	V _{IH2}	0.7V _{DD}		V _{DD}	V	CE terminal
	V _{IH3}	0.6V _{DD}		V _{DD}	V	K0 to K3 terminals
Low Level Input Voltage	V _{IL1}	0		0.3V _{DD}	V	CE terminal
	V _{IL2}	0		0.2V _{DD}	V	SD, K0 to K3 terminals
High Level Output Voltage	V _{OH1}	4.0			V	EO, \bar{D} , MUTE: I _{OH} =-0.5 mA
	V _{OH2}	3.0			V	SEG: I _{OH} =-0.5 mA
	V _{OH3}	4.0			V	PSC: I _{OH} =-0.2 mA
Low Level Output Voltage	V _{OL1}			0.5	V	EO: I _{OL} =0.5 mA
	V _{OL2}			0.5	V	\bar{D} , MUTE, PSC: I _{OL} =0.2 mA
Output Off Leak Current	I _{OFF}			-5.0	μA	SEG: V _{DS} =-30 V
High Level Input Current	I _{IH}	5.0	25	100	μA	K: V _I =V _{DD} =5.0 V
Frequency Response	fin1	0.5		2.5	MHz	AM: v _i =1.0 V _{p-p} , DC cut sine wave
	fin2	0.5		8.8	MHz	FM: v _i =0.8 V _{p-p} , DC cut square wave
Supply Voltage Rise Time	Tr			0.5	s	V _{DD} : 0 → 4.5 V
Supply Current	I _{DD}		0.5	2.0	mA	CE: Low Level

SYSTEM DESCRIPTION

NEC's Digital Tuning System provides full electronic control of a vari-cap tuned FM/AM radio receiver and stereo. The block diagram of the system is shown in Fig. 1. This is a Phase Locked Loop Digital Tuning System which consists of two integrated circuits; controller plus PLL in a single chip, and two-modulus prescaler.

The controller chip (μ PD1703C-013) provides Phase Locked Loop capability with on-chip frequency division, a reference oscillator whose frequency is controlled by an external crystal of 4.5 MHz, and phase comparator circuitry. It accepts directly an AM local oscillator signal and an FM signal from two-modulus prescaler (μ PB553AC), and outputs control signals for closed loop operation of these oscillators. The outputs drives filters for supplying analog voltages to the vari-cap tuners. The controller also provides the signals to drive the display. The frequency of the tuned station is displayed on a 3.5 digit multiplexed display. Six favorite stations on each band can be stored as well as "last stations tuned" information.

The two-modulus prescaler (μ PB553AC) is suitable for pulse swallowing in this system.

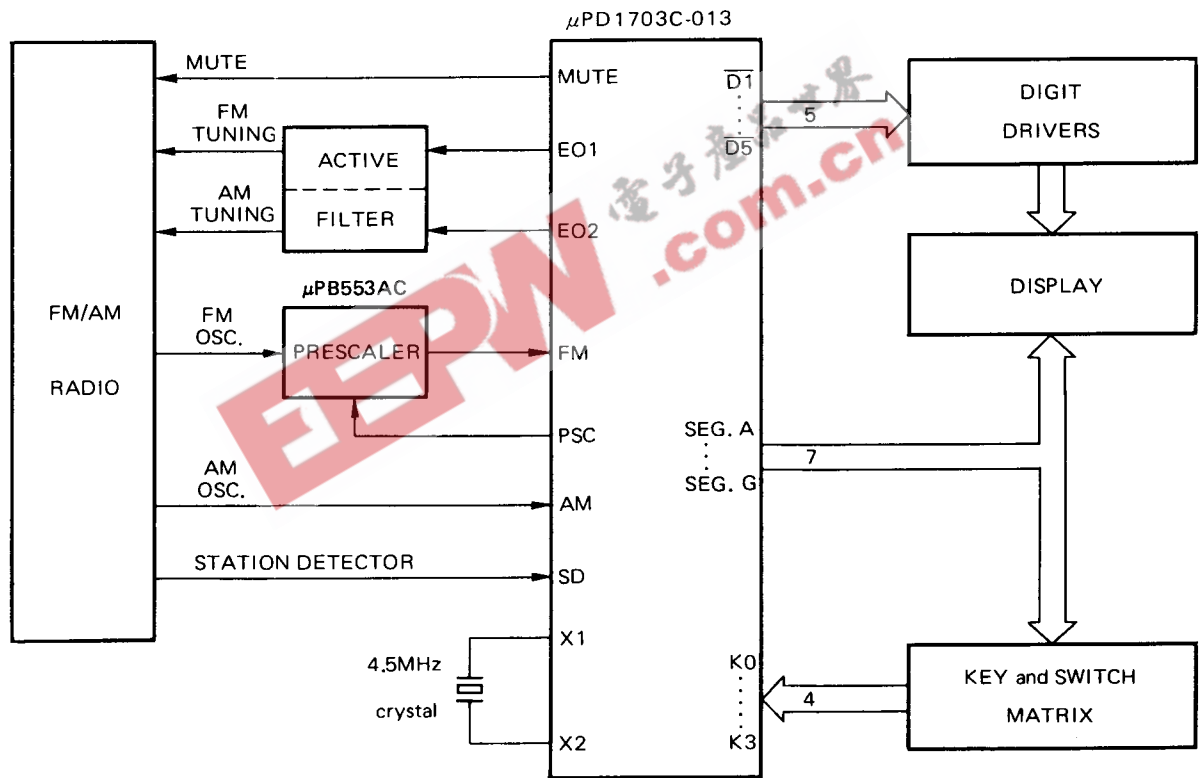
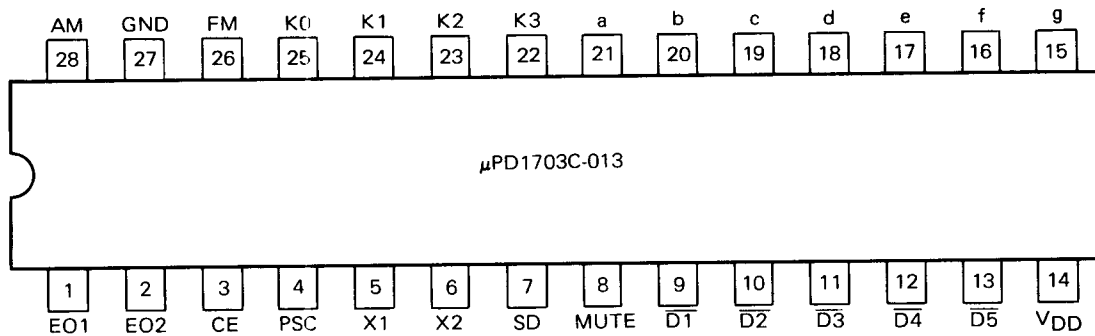

Fig. 1 Block Diagram

PIN CONNECTION (Top View)



EXPLANATION OF INPUT AND OUTPUT TERMINALS

EO1 EO2	These three-state outputs are used (via active filters) to supply analog voltages to the tuner varicap for controlling the local oscillators.
CE	This input is used to designate the stand-by mode to the chip. It is low to designate the stand-by mode. (display: off, PLL: disabled)
PSC	This output is used to control the division ratio of the FM two-modulus prescaler (μPB553AC).
X1, X2	These inputs are for connection to a 4.5 MHz crystal.
SD	This input is used to control the automatic station searching operation. It is high to indicate the presence of a station.
MUTE	This output line is high to mute the radio in the case of station change, band change, and so on.
D1 to D5	These outputs are used as digit drivers for the display. (Active low)
VDD	This is a 4.5 to 5.5 volt supply for the chip.
a to g	These outputs are used as segment drivers for the display. They are also used as vertical drive for the control key and mode switch matrix. (P-ch open drain, Active high)
K0 to K3	These inputs are from seven by four matrix. Various functions are entered through the matrix. See Fig. 2 for the matrix assignments.
FM	This is the FM band local oscillator input. The frequency is divided by 16/17 using a two-modulus prescaler (μPB553AC).
GND	System ground.
AM	This is the AM band local oscillator input.

CONTROL KEY AND MODE SWITCH MATRIX

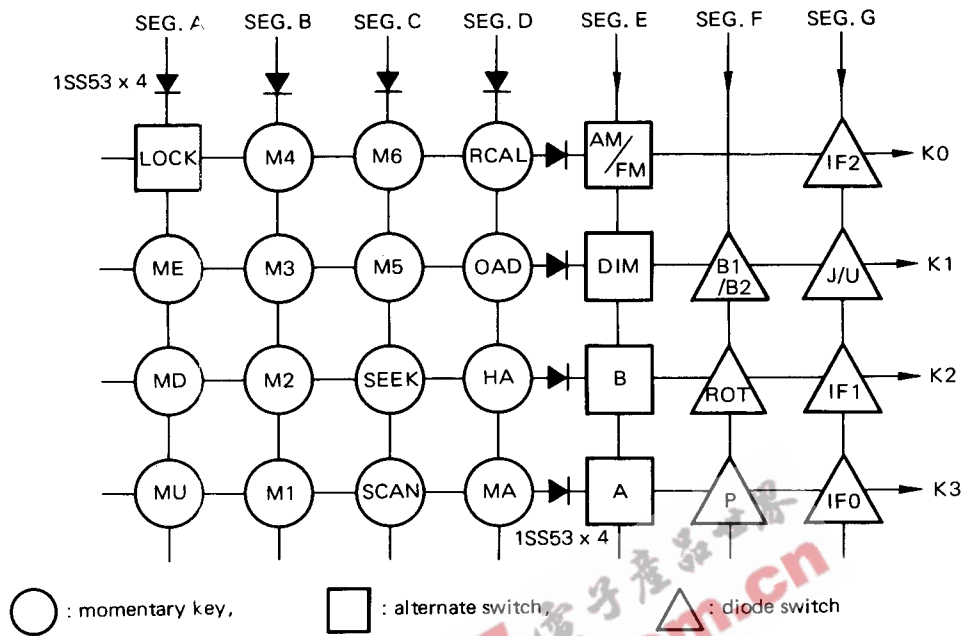

Fig. 2 Control Key and Mode Switch Matrix

* Manual up or down search

MU, MD A momentary depression will tune to next channel, and continuous depression more than 0.5 second allows traversing up or down the entire band until the key is released.

* Automatic up search (Saw-tooth search)

SEEK A momentary depression causes automatic up search which is terminated by activation of SD terminal (active high).

SCAN A momentary depression causes automatic station-to-station search.

* Preset of the station

ME The tuning information is stored into the internal RAM by depressing ME key and then the desired memory key (M1 to M6) within 5 seconds from the time ME key was initially depressed. If any other key is depressed in this period, the ME function is cancelled.

M1 to M6 Six favorite stations can be recalled from internal RAM for each band. When it is switched from one band to the other, it will tune to "last-tuned-to station" on that band. Each time a station is changed, the controller provides a signal to mute the radio.

* Clock set controls

HA, MA These keys are used for hours and minutes setting. (See note)

OAD A momentary depression will reset minutes and seconds.

Note MU and MD keys can be used to set minutes and hours, keeping depressing ME key when time is displayed.

* **Switching-over the display between radio and clock**

A, B, P Display mode switches A, B initial switch P and control key RCAL control the display mode as follows.
 RCAL

1. A: ON, B: ON, P: ANY

No priority on the display. A momentary depression of RCAL key causes alternate display change between time and frequency whenever it is performed. Whenever frequency is handled, frequency is displayed.

2. A: ON, B: OFF, P: OFF

Clock display is prior to frequency. A momentary depression of RCAL key causes alternative display change. When time is displayed, a depression of RCAL or one of the frequency handling key recalls frequency information on the display for 5 seconds. After that, the display turns back to clock automatically.

3. A: ON, B: OFF, P: ON

Frequency is prior to the clock. A momentary depression of RCAL key causes the alternative display change. When frequency is displayed, a momentary depression of RCAL key recalls clock display and it remains there for 5 seconds. If any other key is handled when time is displayed, handling of one of the time adjust keys (HA, MA, OAD) keeps the time display, the display turns back to frequency automatically 5 seconds after the time adjust is completed. Whenever frequency is handled, frequency is displayed.

4. A: OFF, B: OFF, P: ANY

Clock only.

5. A: OFF, B: ON, P: ANY

Disabled.

* **Switching-over the Manual UP/DOWN signal generator**

ROT ON: Pulse repetition rate more than 6 milisecond will be acceptable as MU or MD signal for an application of the endless-rotary switch as the signal generator.

OFF: Pulse repetition rate more than 60 milisecond will be acceptable preventing from miscounting by chattering of the momentary switches applied for UP/DOWN signal generator.

* **Protection from the miss key input**

LOCK This switch is for protection from miss key input.

ON All of the key input is disabled.

OFF All of the key input is enabled.

* **Protection from the key chattering**

Key make time less than 15 ms

Key break time less than 15 ms

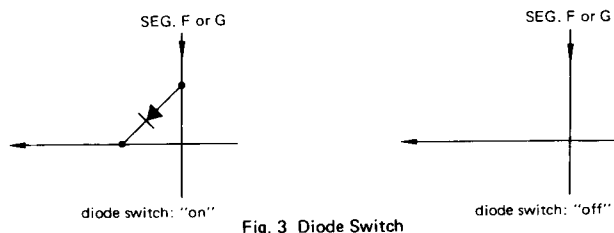

Fig. 3 Diode Switch

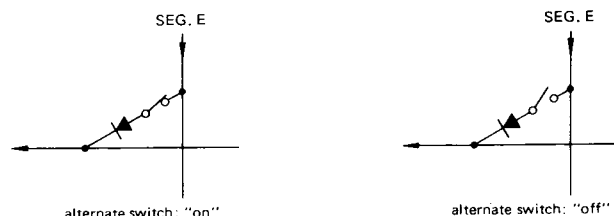

Fig. 4 Alternate Switch

*** Selection of the radio band**

J/U This switch is for selection of the district.

AM/FM This switch is for selection of the radio band.

Band Switch		Selected Band	
J/U	AM/FM		
off	off	FM U.S.	87.9 to 107.9 MHz, channel spacing 200 kHz
	on	AM U.S.	530 to 1620 kHz, channel spacing 10 kHz *3
on	off	FM Japan	76.1 to 89.9 MHz, channel spacing 100 kHz
	on	AM Japan	531 to 1602 kHz, channel spacing 9 kHz

*3: See AM band IF offset

Table 2

*** FM band IF offset**

IF0, IF1 These switches program the chip to accept 4 different intermediate frequencies.

IF0	IF1	Intermediate Frequency	
		Japan	U.S.
on	off	10.750 MHz	10.650 MHz
on	on	10.725 MHz	10.675 MHz
off	off	10.700 MHz	10.700 MHz
off	on	10.675 MHz	10.725 MHz

Table 3

*** AM band IF offset**

IF2 This switch programs the chip to accept 2 different intermediate frequencies.

B1/B2 This switch is for selection of the receiving band and channel spacing of AM radio for U.S. band.

J/U	B1/B2	IF2	Intermediate Frequency	Receiving Frequency	Channel Spacing	
on	X	on	261 kHz	531 to 1602 kHz	9 kHz	
		off	450 kHz			
off	on	on	261 kHz	531 to 1602 kHz	9 kHz	
		off	450 kHz			
	off	off	on	260 kHz	530 to 1620 kHz	10 kHz
			off	450 kHz		

X: Don't care.

Table 4

*** Display interface**

The center frequency of tuned station is displayed on a 3.5 digit FIP. The μ PD1703C-013 provides direct interface to the FIP. The μ PD1703C-013 interfaces with all the devices requiring up to 30 volt levels. The segment outputs go directly to the segments (anodes) of the multi-digit 7 segment FIP. The digit outputs go to PNP transistor array to drive the digits (grids) of the FIP. The LED display can be driven by using appropriate interface circuits.

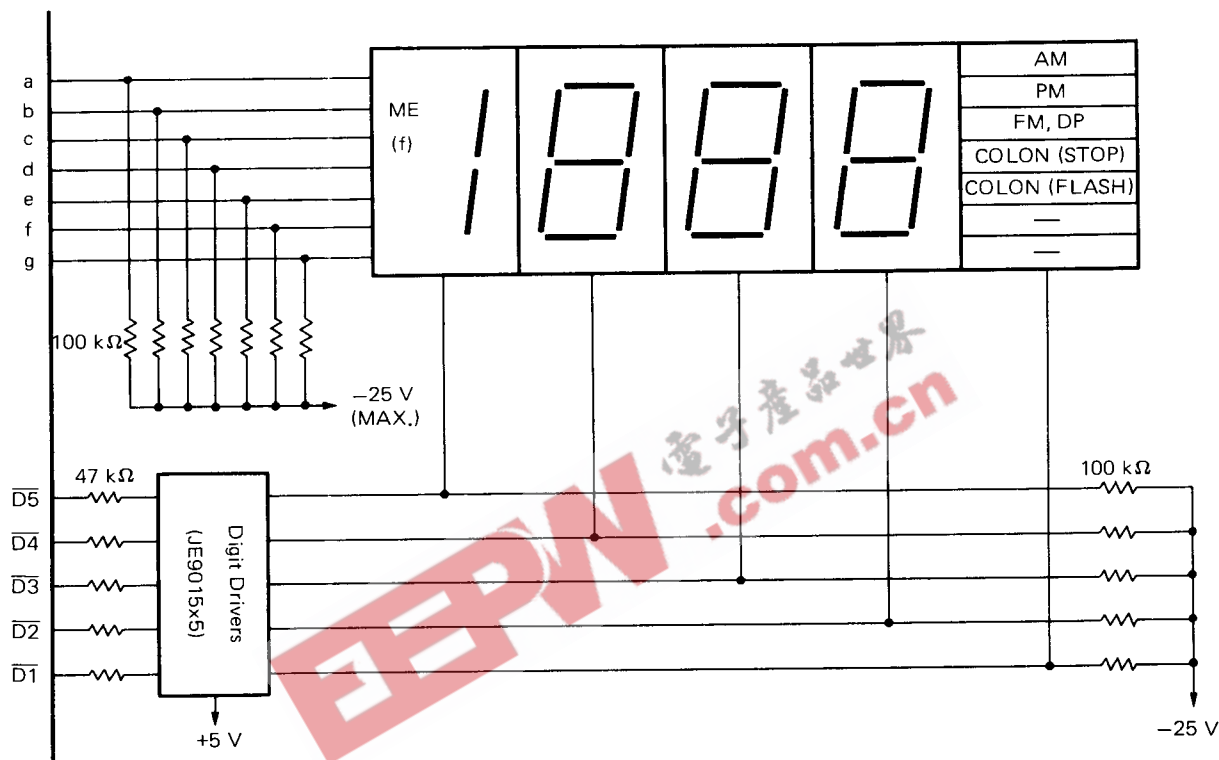
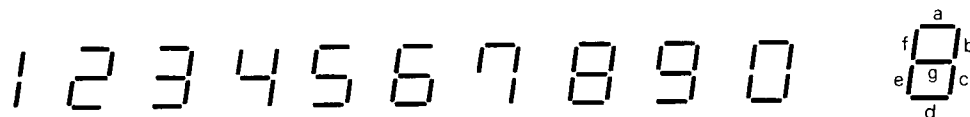

Fig. 4

*** Display format**

○ Segment Pattern



*** Display brightness control (DIMMER)**

- DIM This switch is for selection of display brightness.
- ON — — — — Display brightness is reduced. (Duty factor: 1/32)
 - OFF — — — — Display brightness is ordinary. (Duty factor: 1/8)

