

# DDTC (R2-ONLY SERIES) CA

## NPN PRE-BIASED SMALL SIGNAL SOT-23 SURFACE MOUNT TRANSISTOR

NEW PRODUCT

### Features

- Epitaxial Planar Die Construction
- Complementary PNP Types Available (DDTA)
- Built-In Biasing Resistor, R2 only
- **Lead Free/RoHS Compliant (Note 2)**

### Mechanical Data

- Case: SOT-23
- Case Material: Molded Plastic. UL Flammability Classification Rating 94V-0
- Moisture Sensitivity: Level 1 per J-STD-020C
- Terminal Connections: See Diagram
- Terminals: Solderable per MIL-STD-202, Method 208
- Lead Free Plating (Matte Tin Finish annealed over Alloy 42 leadframe).
- Marking: Date Code and Marking Code (See Table Below & Page 2)
- Ordering Information (See Page 2)
- Weight: 0.008 grams (approximate)

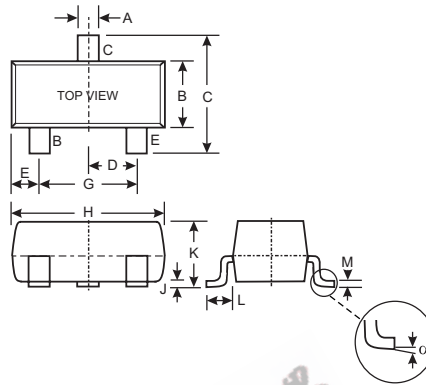

SOT-23		
Dim	Min	Max
A	0.37	0.51
B	1.20	1.40
C	2.30	2.50
D	0.89	1.03
E	0.45	0.60
G	1.78	2.05
H	2.80	3.00
J	0.013	0.10
K	0.903	1.10
L	0.45	0.61
M	0.085	0.180
$\alpha$	0°	8°
All Dimensions in mm		

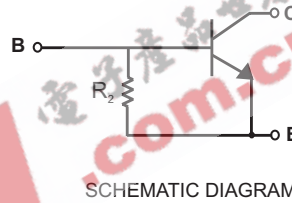

P/N	R2 (NOM)	MARKING
DDTC114GCA	10K $\Omega$	N26
DDTC124GCA	22K $\Omega$	N27
DDTC144GCA	47K $\Omega$	N28
DDTC115GCA	100K $\Omega$	N29

### Maximum Ratings @ T<sub>A</sub> = 25°C unless otherwise specified

Characteristic	Symbol	Value	Unit
Collector-Base Voltage	V <sub>CBO</sub>	50	V
Collector-Emitter Voltage	V <sub>CEO</sub>	50	V
Emitter-Base Voltage	V <sub>EBO</sub>	5	V
Collector Current	I <sub>C</sub> (Max)	100	mA
Power Dissipation	P <sub>d</sub>	200	mW
Thermal Resistance, Junction to Ambient Air (Note 1)	R <sub>θJA</sub>	625	°C/W
Operating and Storage and Temperature Range	T <sub>J</sub> , T <sub>STG</sub>	-55 to +150	°C

- Note: 1. Mounted on FR4 PC Board with recommended pad layout at <http://www.diodes.com/datasheets/ap02001.pdf>.  
2. No purposefully added lead.

**Electrical Characteristics** @ T<sub>A</sub> = 25°C unless otherwise specified

Characteristic		Symbol	Min	Typ	Max	Unit	Test Condition
Collector-Base Breakdown Voltage		BV <sub>CBO</sub>	50	—	—	V	I <sub>C</sub> = 50μA
Collector-Emitter Breakdown Voltage		BV <sub>CEO</sub>	50	—	—	V	I <sub>C</sub> = 1mA
Emitter-Base Breakdown Voltage		BV <sub>EBO</sub>	5	—	—	V	I <sub>E</sub> = 720μA, DDTC114GCA I <sub>E</sub> = 330μA, DDTC124GCA I <sub>E</sub> = 160μA, DDTC144GCA I <sub>E</sub> = 72μA, DDTC115GCA
Collector Cutoff Current		I <sub>CBO</sub>	—	—	0.5	μA	V <sub>CB</sub> = 50V
Emitter Cutoff Current	DDTC114GCA	I <sub>EBO</sub>	300	—	580	μA	V <sub>EB</sub> = 4V
	DDTC124GCA		140		260		
	DDTC144GCA		65		130		
	DDTC115GCA		30		58		
Collector-Emitter Saturation Voltage		V <sub>CE(sat)</sub>	—	—	0.3	V	I <sub>C</sub> = 10mA, I <sub>B</sub> = 0.5mA
DC Current Transfer Ratio	DDTC114GCA	h <sub>FE</sub>	30	—	—	—	I <sub>C</sub> = 5mA, V <sub>CE</sub> = 5V
	DDTC124GCA		56				
	DDTC144GCA		68				
	DDTC115GCA		82				
Bleeder Resistor (R <sub>2</sub> ) Tolerance		ΔR <sub>2</sub>	-30	—	+30	%	—
Gain-Bandwidth Product*		f <sub>T</sub>	—	250	—	MHz	V <sub>CE</sub> = 10V, I <sub>E</sub> = -5mA, f = 100MHz

\* Transistor - For Reference Only

**Ordering Information** (Note 3)

Device	Packaging	Shipping
DDTC114GCA-7-F	SOT-23	3000/Tape & Reel
DDTC124GCA-7-F	SOT-23	3000/Tape & Reel
DDTC144GCA-7-F	SOT-23	3000/Tape & Reel
DDTC115GCA-7-F	SOT-23	3000/Tape & Reel

Notes: 3. For Packaging Details, go to our website at <http://www.diodes.com/datasheets/ap02007.pdf>.

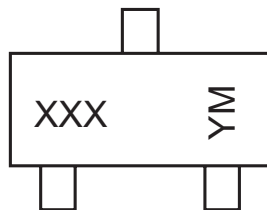
**Marking Information**

XXX = Product Type Marking Code, See Table on Page 1  
 YM = Date Code Marking  
 Y = Year ex: N = 2002  
 M = Month ex: 9 = September

Date Code Key

Year	2002	2003	2004	2005	2006	2007	2008	2009
Code	N	P	R	S	T	U	V	W

Month	Jan	Feb	March	Apr	May	Jun	Jul	Aug	Sep	Oct	Nov	Dec
Code	1	2	3	4	5	6	7	8	9	O	N	D

**TYPICAL CURVES - DDTC114GCA**

NEW PRODUCT

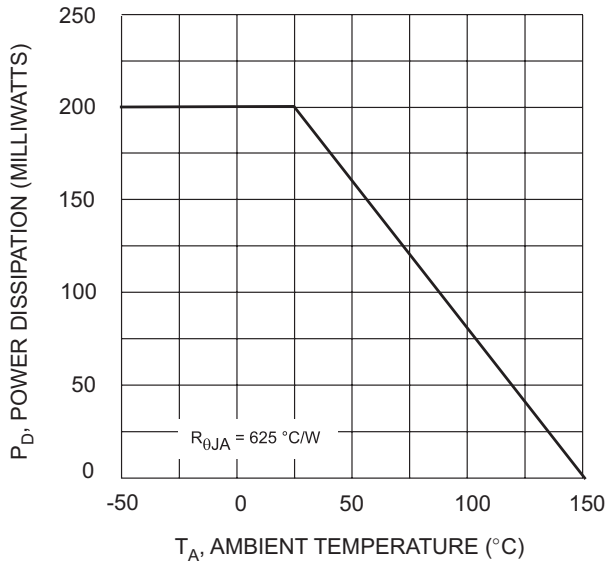

Fig. 1 Derating Curve

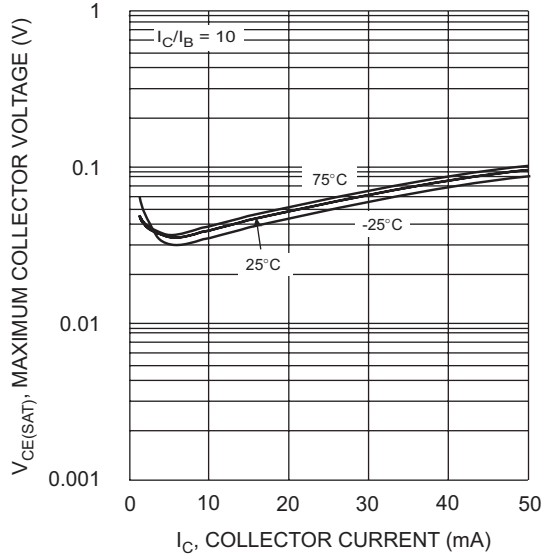

Fig. 2  $V_{CE(SAT)}$  vs.  $I_C$

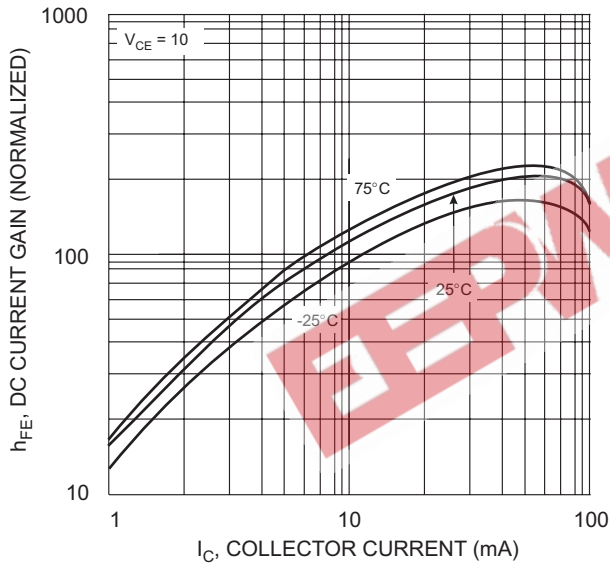

Fig. 3 DC CURRENT GAIN

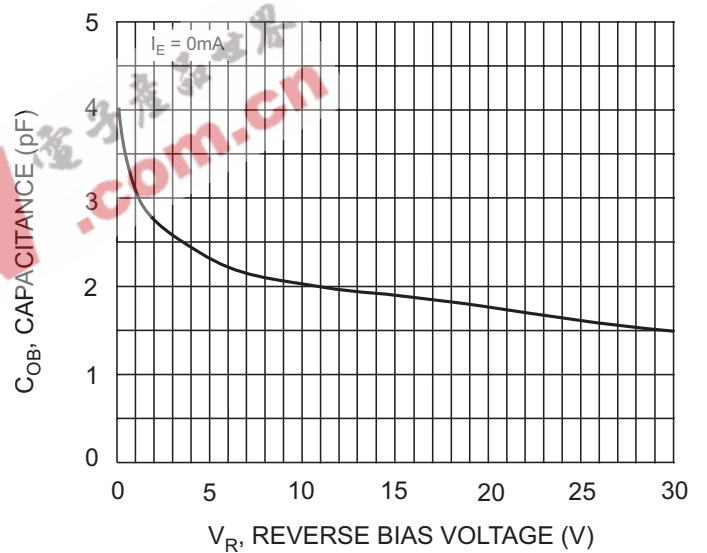

Fig. 4 Output Capacitance

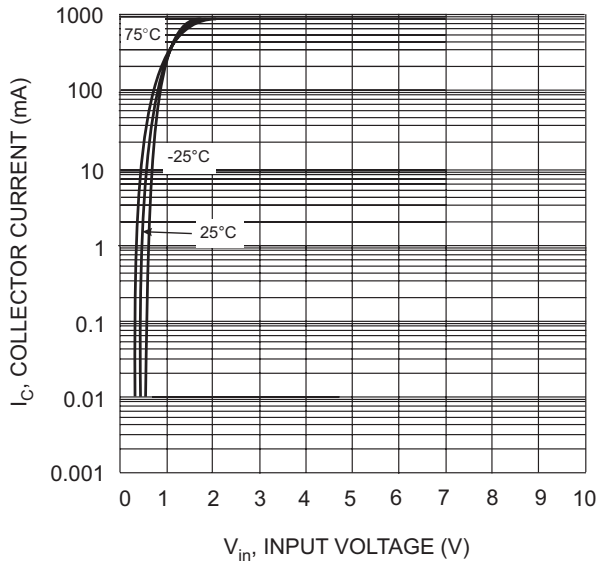

Fig. 5 Collector Current Vs. Input Voltage

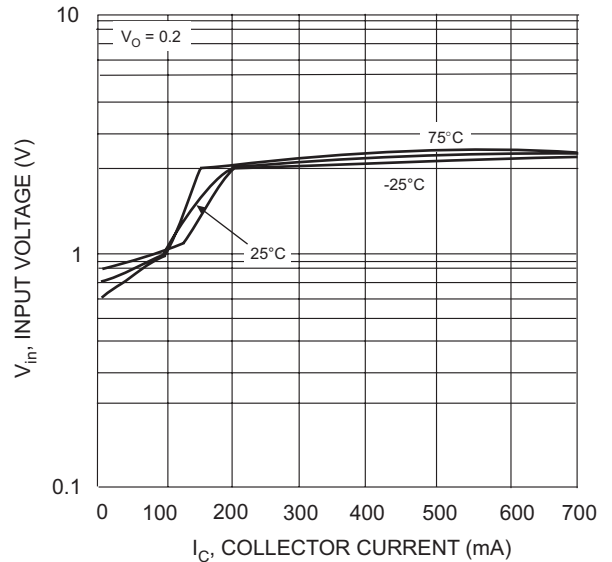

Fig. 6 Input Voltage vs. Collector Current



#### IMPORTANT NOTICE

Diodes, Inc. and its subsidiaries reserve the right to make changes without further notice to any product herein to make corrections, modifications, enhancements, improvements, or other changes. Diodes, Inc. does not assume any liability arising out of the application or use of any product described herein; neither does it convey any license under its patent rights, nor the rights of others. The user of products in such applications shall assume all risks of such use and will agree to hold Diodes Incorporated and all the companies whose products are represented on our website, harmless against all damages.

#### LIFE SUPPORT

The products located on our website at [www.diodes.com](http://www.diodes.com) are not recommended for use in life support systems where a failure or malfunction of the component may directly threaten life or cause injury without the expressed written approval of Diodes Incorporated.

EEPW 电子產品世界  
.com.cn