

54LS367A/DM54LS367A/DM74LS367A Hex TRI-STATE® Buffers

General Description

This device contains six independent gates each of which performs a non-inverting buffer function. The outputs have the TRI-STATE feature. When enabled, the outputs exhibit the low impedance characteristics of a standard LS output with additional drive capability to permit the driving of bus lines without external resistors. When disabled, both the output transistors are turned off presenting a high-impedance state to the bus line. Thus the output will act neither as a significant load nor as a driver. To minimize the possibility

that two outputs will attempt to take a common bus to opposite logic levels, the disable time is shorter than the enable time of the outputs.

Features

- Alternate military/aerospace device (54LS367A) is available. Contact a National Semiconductor sales office/distributor for specifications.

Connection Diagram

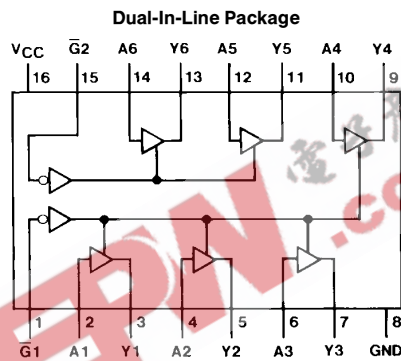

TL/F/6429-1

Order Number 54LS367ADMQB, 54LS367AFMQB, 54LS367ALMQB, DM54LS367AJ,
DM54LS367AW, DM74LS367AM or DM74LS367AN
See NS Package Number E20A, J16A, M16A, N16E or W16A

Function Table

$$Y = A$$

| Inputs | | Output |
|--------|-----------|--------|
| A | \bar{G} | Y |
| L | L | L |
| H | L | H |
| X | H | Hi-Z |

H = High Logic Level

L = Low Logic Level

X = Either Low or High Logic Level

Hi-Z = TRI-STATE (Outputs are disabled)

TRI-STATE® is a registered trademark of National Semiconductor Corporation.

Absolute Maximum Ratings (Note)

If Military/Aerospace specified devices are required, please contact the National Semiconductor Sales Office/Distributors for availability and specifications.

| | |
|--------------------------------------|-----------------|
| Supply Voltage | 7V |
| Input Voltage | 7V |
| Operating Free Air Temperature Range | |
| DM54LS | –55°C to +125°C |
| DM74LS | 0°C to +70°C |
| Storage Temperature Range | –65°C to +150°C |

Note: The "Absolute Maximum Ratings" are those values beyond which the safety of the device cannot be guaranteed. The device should not be operated at these limits. The parametric values defined in the "Electrical Characteristics" table are not guaranteed at the absolute maximum ratings. The "Recommended Operating Conditions" table will define the conditions for actual device operation.

Recommended Operating Conditions

| Symbol | Parameter | DM54LS367A | | | DM74LS367A | | | Units |
|-----------------|--------------------------------|------------|-----|-----|------------|-----|------|-------|
| | | Min | Nom | Max | Min | Nom | Max | |
| V _{CC} | Supply Voltage | 4.5 | 5 | 5.5 | 4.75 | 5 | 5.25 | V |
| V _{IH} | High Level Input Voltage | 2 | | | 2 | | | V |
| V _{IL} | Low Level Input Voltage | | | 0.7 | | | 0.8 | V |
| I _{OH} | High Level Output Current | | | –1 | | | –2.6 | mA |
| I _{OL} | Low Level Output Current | | | 12 | | | 24 | mA |
| T _A | Free Air Operating Temperature | –55 | | 125 | 0 | | 70 | °C |

Electrical Characteristics over recommended operating free air temperature range (unless otherwise noted)

| Symbol | Parameter | Conditions | Min | Typ (Note 1) | Max | Units | |
|------------------|---|--|-----------------|--------------|------|-------|----|
| V _I | Input Clamp Voltage | V _{CC} = Min, I _I = –18 mA | | | –1.5 | V | |
| V _{OH} | High Level Output Voltage | V _{CC} = Min, I _{OH} = Max V _{IL} = Max, V _{IH} = Min | 2.4 | 3.4 | | V | |
| V _{OL} | Low Level Output Voltage | V _{CC} = Min, I _{OL} = Max V _{IL} = Max, V _{IH} = Min | DM54 | 0.25 | 0.4 | V | |
| | | | DM74 | 0.35 | 0.5 | | |
| | | I _{OL} = 12 mA, V _{CC} = Min | DM74 | 0.25 | 0.4 | | |
| I _I | Input Current @ Max Input Voltage | V _{CC} = Max, V _I = 7V | | | 0.1 | mA | |
| I _{IH} | High Level Input Current | V _{CC} = Max, V _I = 2.7V | | | 20 | μA | |
| I _{IL} | Low Level Input Current | V _{CC} = Max, V _I = 0.5V (Note 4) | A Input | | | –20 | μA |
| | | V _{CC} = Max, V _I = 0.4V (Note 5) | A Input | | | –0.4 | mA |
| | | V _{CC} = Max, V _I = 0.4V | \bar{G} Input | | | –0.4 | |
| I _{OZH} | Off-State Output Current with High Level Output Voltage Applied | V _{CC} = Max, V _O = 2.4V V _{IH} = Min, V _{IL} = Max | | | 20 | μA | |
| I _{OZL} | Off-State Output Current with Low Level Output Voltage Applied | V _{CC} = Max, V _O = 0.4V V _{IH} = Min, V _{IL} = Max | | | –20 | μA | |
| I _{OS} | Short Circuit Output Current | V _{CC} = Max (Note 2) | DM54 | –20 | | –100 | mA |
| | | | DM74 | –20 | | –100 | |
| I _{CC} | Supply Current | V _{CC} = Max (Note 3) | | 14 | 24 | mA | |

Note 1: All typicals are at V_{CC} = 5V, T_A = 25°C.

Note 2: Not more than one output should be shorted at a time, and the duration should not exceed one second.

Note 3: I_{CC} is measured with the DATA inputs grounded and the OUTPUT CONTROLS at 4.5V.

Note 4: Both \bar{G} inputs are at 2V.

Note 5: Both \bar{G} inputs at 0.4V.

Switching Characteristics at $V_{CC} = 5V$ and $T_A = 25^\circ C$ (See Section 1 for Test Waveforms and Output Load)

| Symbol | Parameter | $R_L = 667\Omega$ | | | | Units |
|-----------|---|----------------------|-----|-----------------------|-----|-------|
| | | $C_L = 50\text{ pF}$ | | $C_L = 150\text{ pF}$ | | |
| | | Min | Max | Min | Max | |
| t_{PLH} | Propagation Delay Time Low to High Level Output | | 16 | | 25 | ns |
| t_{PHL} | Propagation Delay Time High to Low Level Output | | 16 | | 25 | ns |
| t_{PZH} | Output Enable Time to High Level Output | | 30 | | 40 | ns |
| t_{PZL} | Output Enable Time to Low Level Output | | 30 | | 40 | ns |
| t_{PHZ} | Output Disable Time from High Level Output (Note 6) | | 20 | | | ns |
| t_{PLZ} | Output Disable Time from Low Level Output (Note 6) | | 20 | | | ns |

Note 6: $C_L = 5\text{ pF}$.

EEPW 电子产品世界
.com.cn

Physical Dimensions inches (millimeters)

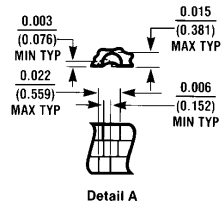
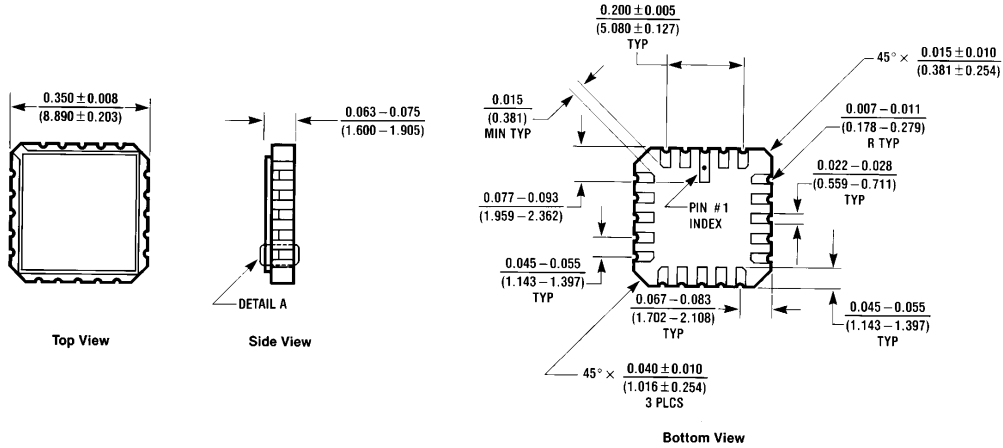

Ceramic Leadless Chip Carrier Package (E)
 Order Number 54LS367ALMQB
 NS Package Number E20A

E20A (REV D)

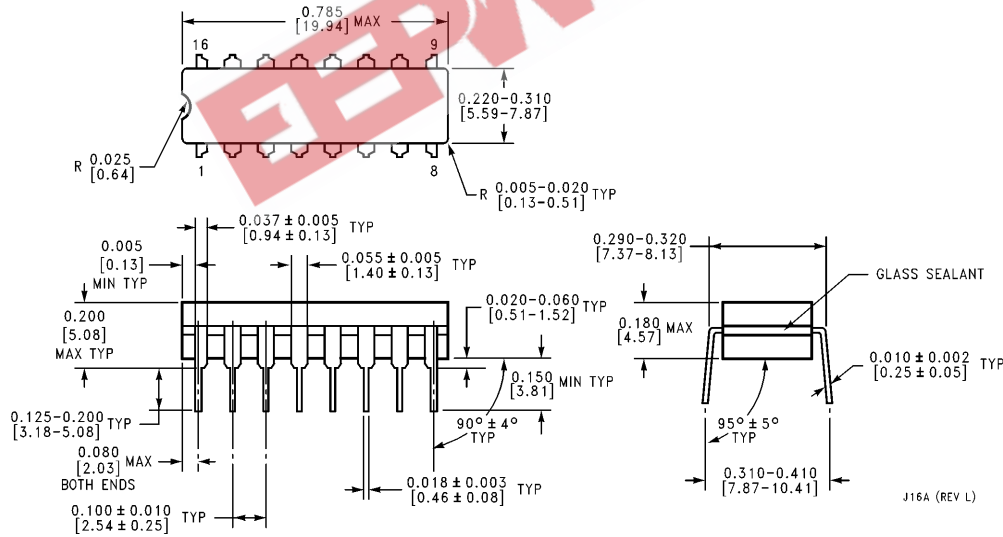

Ceramic Dual-In-Line Package (J)
 Order Number 54LS367ADMQB or DM54LS367AJ
 NS Package Number J16A

J16A (REV L)

Physical Dimensions inches (millimeters) (Continued)

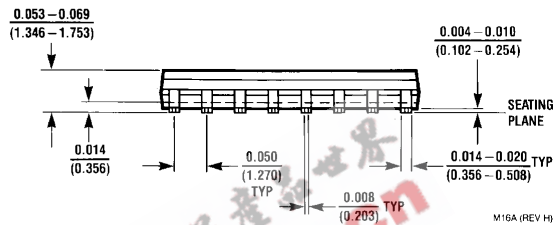
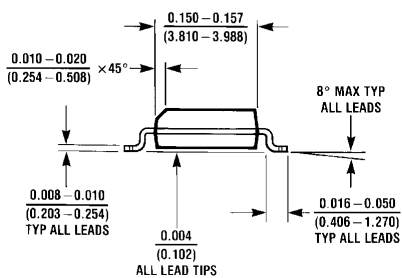
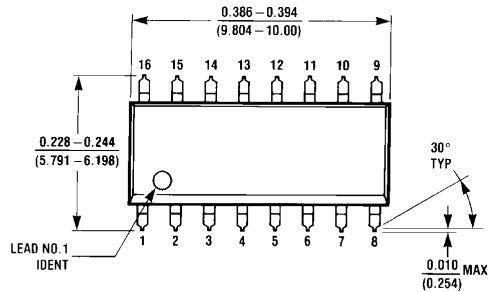

M16A (REV H)

16-Lead Small Outline Molded Package (M)
Order Number DM74LS367AM
NS Package Number M16A

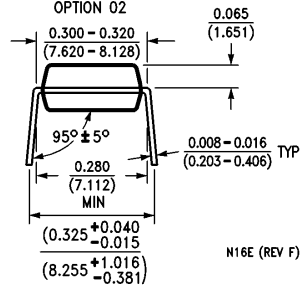
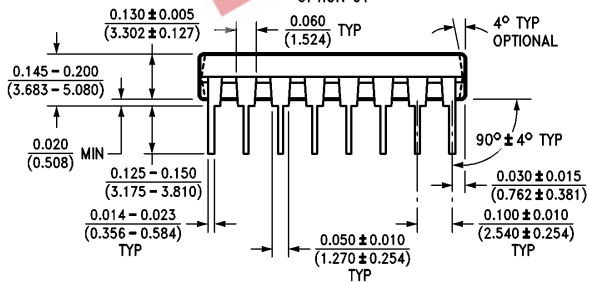
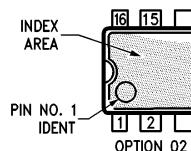
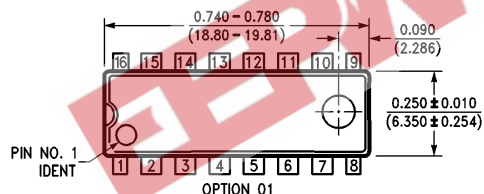

N16E (REV F)

16-Lead Molded Dual-In-Line Package (N)
Order Number DM74LS367AN
NS Package Number N16E

Physical Dimensions inches (millimeters) (Continued)

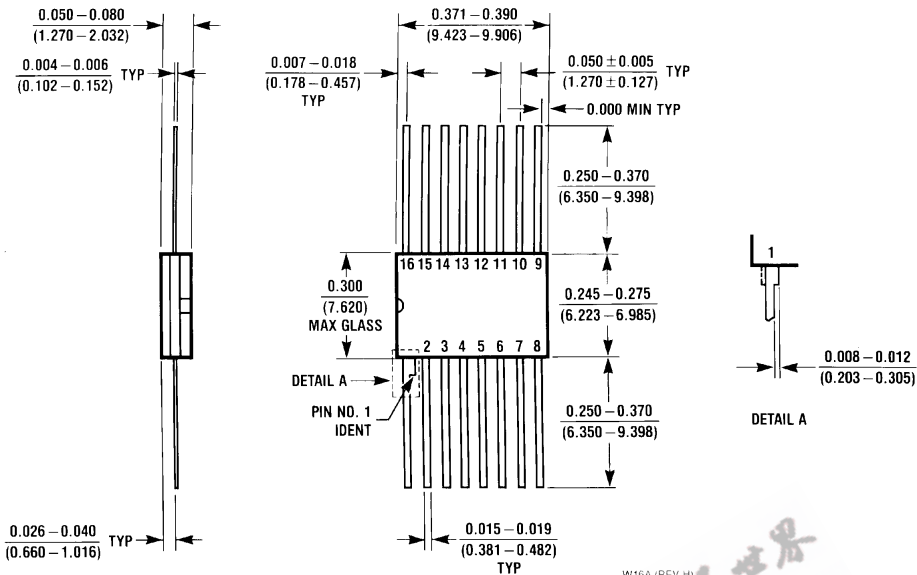

16-Lead Ceramic Flat Package (W)
Order Number 54LS367AFMQB or DM54LS367AW
NS Package Number W16A

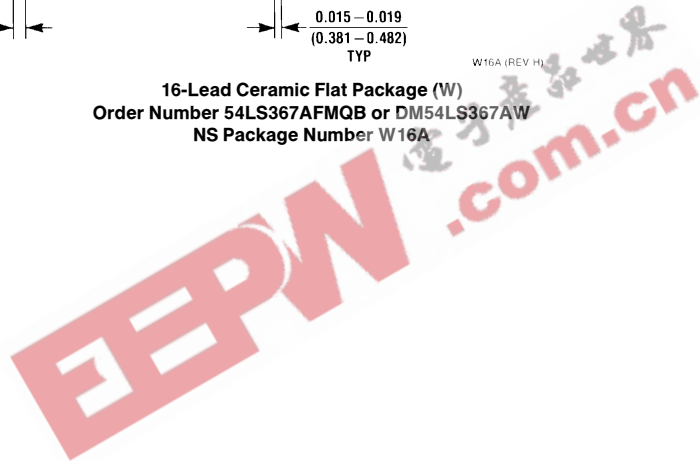

LIFE SUPPORT POLICY

NATIONAL'S PRODUCTS ARE NOT AUTHORIZED FOR USE AS CRITICAL COMPONENTS IN LIFE SUPPORT DEVICES OR SYSTEMS WITHOUT THE EXPRESS WRITTEN APPROVAL OF THE PRESIDENT OF NATIONAL SEMICONDUCTOR CORPORATION. As used herein:

1. Life support devices or systems are devices or systems which, (a) are intended for surgical implant into the body, or (b) support or sustain life, and whose failure to perform, when properly used in accordance with instructions for use provided in the labeling, can be reasonably expected to result in a significant injury to the user.
2. A critical component is any component of a life support device or system whose failure to perform can be reasonably expected to cause the failure of the life support device or system, or to affect its safety or effectiveness.



National Semiconductor Corporation
 1111 West Bardin Road
 Arlington, TX 76017
 Tel: 1(800) 272-9959
 Fax: 1(800) 737-7018

National Semiconductor Europe
 Fax: (+49) 0-180-530 85 86
 Email: cnjwge@levm2.nsc.com
 Deutsch Tel: (+49) 0-180-530 85 85
 English Tel: (+49) 0-180-532 78 32
 Français Tel: (+49) 0-180-532 93 58
 Italiano Tel: (+49) 0-180-534 16 80

National Semiconductor Hong Kong Ltd.
 13th Floor, Straight Block,
 Ocean Centre, 5 Canton Rd.
 Tsimshatsui, Kowloon
 Hong Kong
 Tel: (852) 2737-1600
 Fax: (852) 2736-9960

National Semiconductor Japan Ltd.
 Tel: 81-043-299-2309
 Fax: 81-043-299-2408

National does not assume any responsibility for use of any circuitry described, no circuit patent licenses are implied and National reserves the right at any time without notice to change said circuitry and specifications.