

54LS379/DM74LS379 Quad Parallel Register with Enable

General Description

The LS379 is a 4-bit register with buffered common Enable. This device is similar to the LS175 but features the common Enable rather than common Master Reset.

Features

- Edge-triggered D-type inputs
- Buffered positive edge-triggered clock
- Buffered common enable input
- True and complement outputs

Connection Diagram

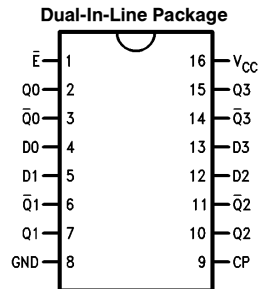

Logic Symbol

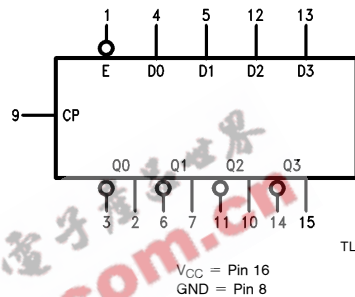

Order Number 54LS379DMQB, 54LS379FMQB,
54LS379LMQB, DM74LS379M or DM74LS379N
See NS Package Number E20A,
J16A, M16A, N16E or W16A

Pin Names	Description
\bar{E}	Enable Input (Active LOW)
D0–D3	Data Inputs
CP	Clock Pulse Input (Active Rising Edge)
Q0–Q3	Flip-Flop Outputs
$\bar{Q}0$ – $\bar{Q}3$	Complement Outputs

Absolute Maximum Ratings (Note)

If Military/Aerospace specified devices are required, please contact the National Semiconductor Sales Office/Distributors for availability and specifications.

Supply Voltage	7V
Input Voltage	7V
Operating Free Air Temperature Range	
54LS	–55°C to +125°C
DM74LS	0°C to +70°C
Storage Temperature Range	–65°C to +150°C

Note: The "Absolute Maximum Ratings" are those values beyond which the safety of the device cannot be guaranteed. The device should not be operated at these limits. The parametric values defined in the "Electrical Characteristics" table are not guaranteed at the absolute maximum ratings. The "Recommended Operating Conditions" table will define the conditions for actual device operation.

Recommended Operating Conditions

Symbol	Parameter	54LS379			DM74LS379			Units
		Min	Nom	Max	Min	Nom	Max	
V _{CC}	Supply Voltage	4.5	5	5.5	4.75	5	5.25	V
V _{IH}	High Level Input Voltage	2			2			V
V _{IL}	Low Level Input Voltage			0.7			0.8	V
I _{OH}	High Level Output Current			–0.4			–0.4	mA
I _{OL}	Low Level Output Current			4			8	mA
T _A	Free Air Operating Temperature	–55		125	0		70	°C
t _s (H) t _s (L)	Setup Time HIGH or LOW Dn to CP	20			20			ns
t _h (H) t _h (L)	Hold Time HIGH or LOW Dn to CP	5			5			ns
t _s (H) t _s (L)	Setup Time HIGH or LOW E̅ to CP	25			25			ns
t _h (H) t _h (L)	Hold Time HIGH or LOW E̅ to CP	5			5			ns
t _w (L)	CP Pulse Width LOW	17			17			ns

Electrical Characteristics over recommended operating free air temperature range (unless otherwise noted)

Symbol	Parameter	Conditions	Min	Typ (Note 1)	Max	Units
V _I	Input Clamp Voltage	V _{CC} = Min, I _I = –18 mA			–1.5	V
V _{OH}	High Level Output Voltage	V _{CC} = Min, I _{OH} = Max, V _{IL} = Max	54LS 2.5 DM74 2.7			V
V _{OL}	Low Level Output Voltage	V _{CC} Min, I _{OL} = Max, V _{IH} = Min	54LS DM74		0.4 0.5	V
		I _{OL} = 4 mA, V _{CC} = Min	DM74		0.4	
I _I	Input Current @ Max Input Voltage	V _{CC} = Max, V _I = 10V			0.1	mA
I _{IH}	High Level Input Current	V _{CC} = Max, V _I = 2.7V			20	μA
I _{IL}	Low Level Input Current	V _{CC} = Max, V _I = 0.4V			–0.4	mA
I _{OS}	Short Circuit Output Current	V _{CC} = Max (Note 2)	54LS –20 DM74 –20		–100 –100	mA
I _{CC}	Supply Current	V _{CC} = Max			18	mA

Note 1: All typicals are at V_{CC} = 5V, T_A = 25°C.

Note 2: Note more than one output should be shorted at a time, and the duration should not exceed one second.

Switching Characteristics



$V_{CC} = +5.0V$, $T_A = +25^\circ C$ (See Section 1 for test waveforms and output load)

Symbol	Parameter	$R_L = 2\text{ k}\Omega$, $C_L = 15\text{ pF}$		Units
		Min	Max	
f_{\max}	Maximum Clock Frequency	30		MHz
t_{PLH} t_{PHL}	Propagation Delay CP to Qn		27 27	ns

Functional Description

The LS379 consists of four edge-triggered D-type flip-flops with individual D inputs and Q and \bar{Q} outputs. The Clock (CP) and Enable (\bar{E}) inputs are common to all flip-flops. When the \bar{E} input is HIGH, the register will retain the present data independent of the CP input. The Dn and \bar{E} inputs can change when the clock is in either state, provided that the recommended setup and hold times are observed.

Truth Table

Inputs			Outputs	
\bar{E}	CP	Dn	Qn	$\bar{Q}n$
H		X	No Change	No Change
L		H	H	L
L		L	L	H

H = HIGH Voltage Level
L = LOW Voltage Level
X = Immaterial

Logic Diagram

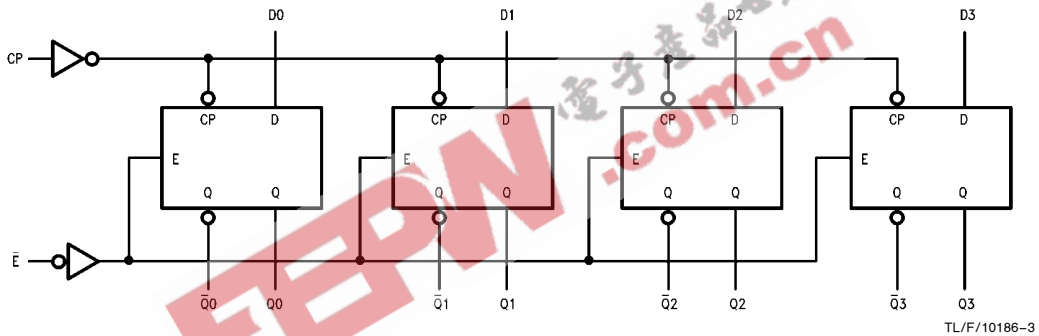

Physical Dimensions inches (millimeters)

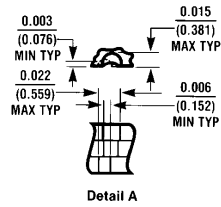
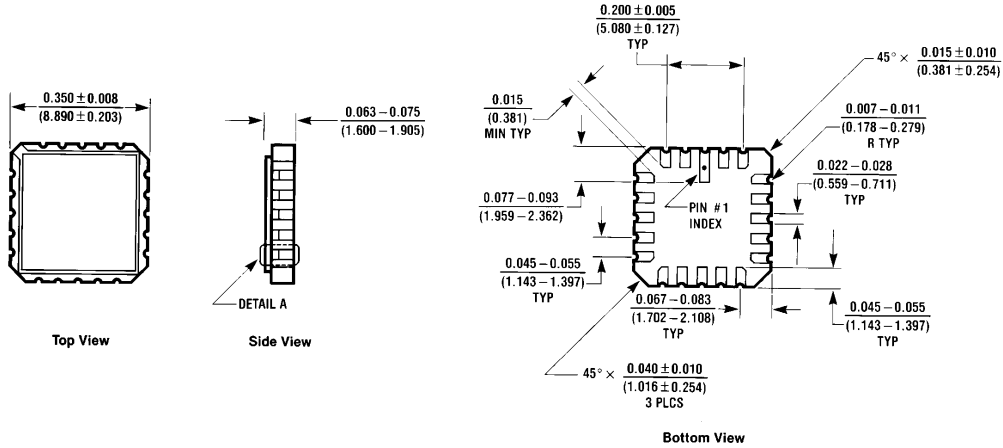

Ceramic Leadless Chip Carrier Package (E)
 Order Number 54LS379LMQB
 NS Package Number E20A

E20A (REV D)

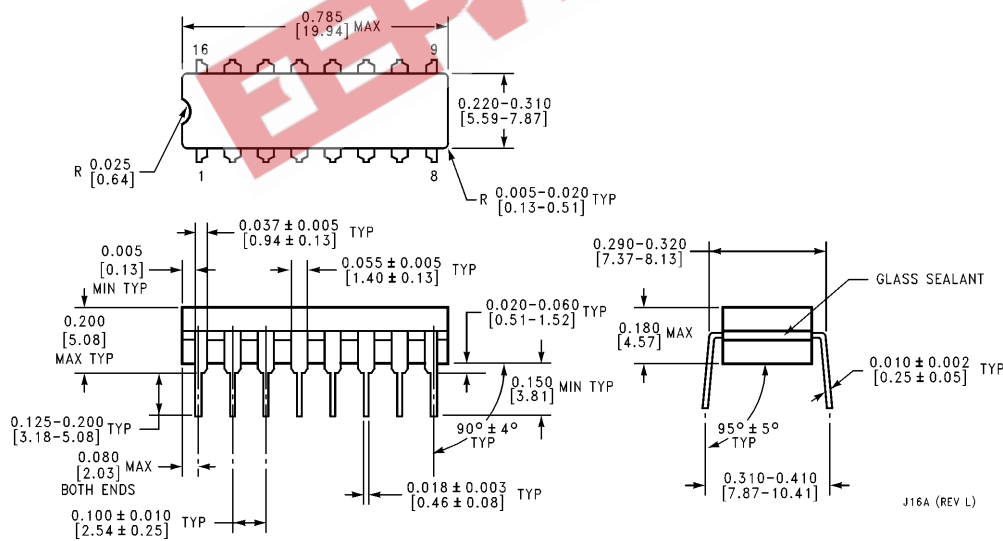

16-Lead Ceramic Dual-In-Line Package (J)
 Order Number 54LS379DMQB
 NS Package Number J16A

J16A (REV L)

Physical Dimensions inches (millimeters)

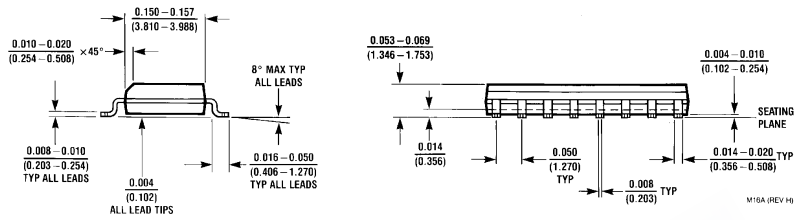
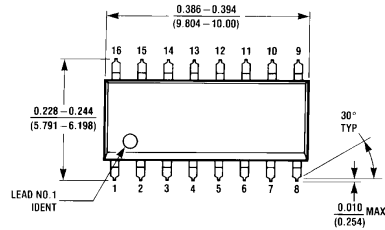

16-Lead Small Outline Molded Package (M)
Order Number DM74LS379M
NS Package Number M16A

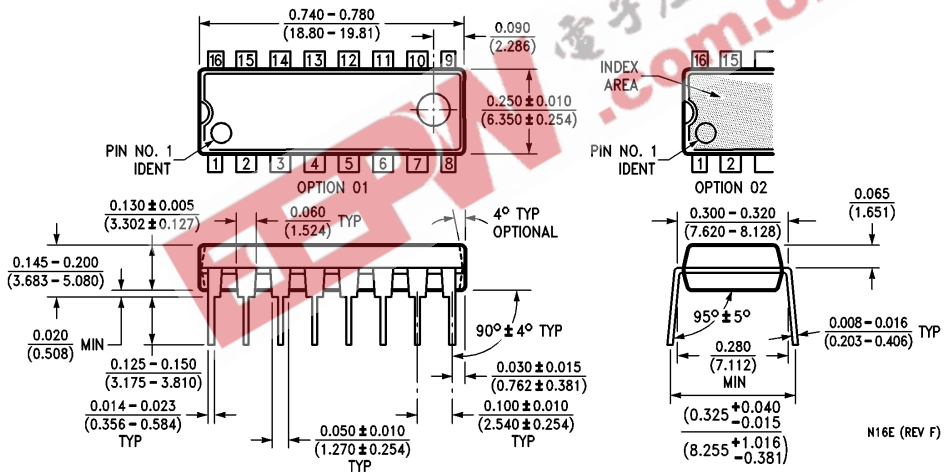

16-Lead Molded Dual-In-Line Package (N)
Order Number DM74LS379N
NS Package Number N16E

Physical Dimensions inches (millimeters)

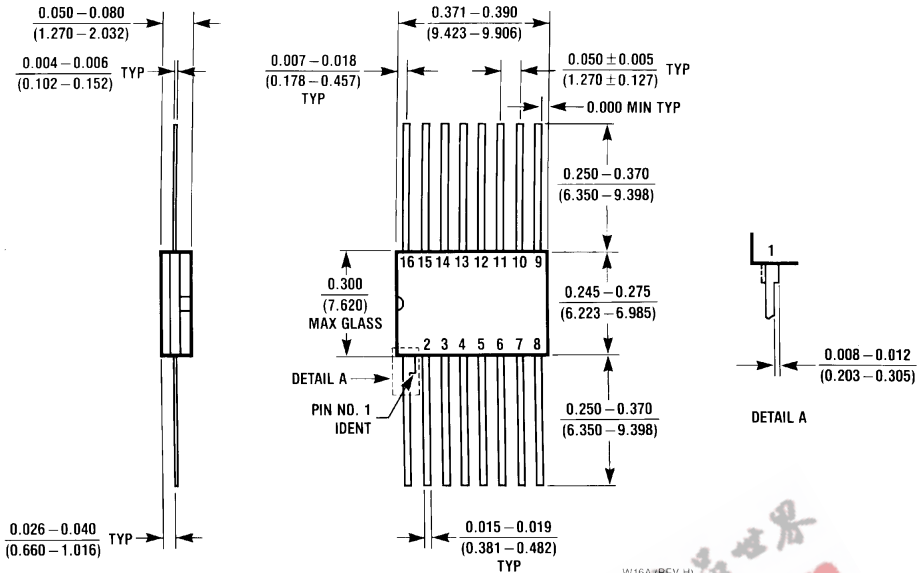

16-Lead Ceramic Flat Package (W)
Order Number 54LS379FMB
NS Package Number W16A

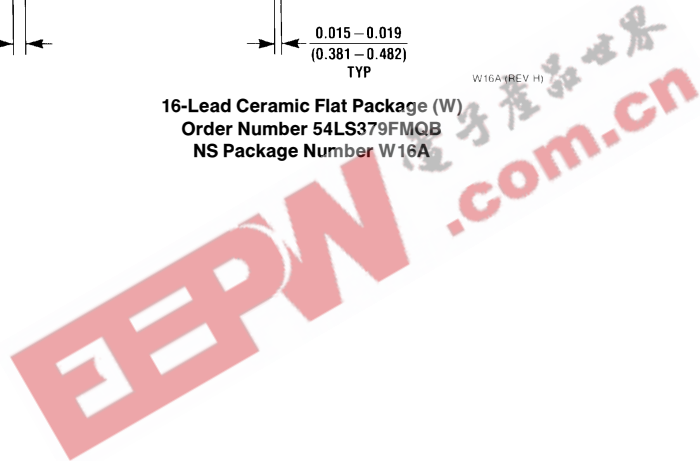

LIFE SUPPORT POLICY

NATIONAL'S PRODUCTS ARE NOT AUTHORIZED FOR USE AS CRITICAL COMPONENTS IN LIFE SUPPORT DEVICES OR SYSTEMS WITHOUT THE EXPRESS WRITTEN APPROVAL OF THE PRESIDENT OF NATIONAL SEMICONDUCTOR CORPORATION. As used herein:

1. Life support devices or systems are devices or systems which, (a) are intended for surgical implant into the body, or (b) support or sustain life, and whose failure to perform, when properly used in accordance with instructions for use provided in the labeling, can be reasonably expected to result in a significant injury to the user.
2. A critical component is any component of a life support device or system whose failure to perform can be reasonably expected to cause the failure of the life support device or system, or to affect its safety or effectiveness.



National Semiconductor Corporation
 1111 West Bardin Road
 Arlington, TX 76017
 Tel: 1(800) 272-9959
 Fax: 1(800) 737-7018

National Semiconductor Europe
 Fax: (+49) 0-180-530 85 86
 Email: cnjwge@levm2.nsc.com
 Deutsch Tel: (+49) 0-180-530 85 85
 English Tel: (+49) 0-180-532 78 32
 Français Tel: (+49) 0-180-532 93 58
 Italiano Tel: (+49) 0-180-534 16 80

National Semiconductor Hong Kong Ltd.
 13th Floor, Straight Block,
 Ocean Centre, 5 Canton Rd.
 Tsimshatsui, Kowloon
 Hong Kong
 Tel: (852) 2737-1600
 Fax: (852) 2736-9960

National Semiconductor Japan Ltd.
 Tel: 81-043-299-2309
 Fax: 81-043-299-2408

National does not assume any responsibility for use of any circuitry described, no circuit patent licenses are implied and National reserves the right at any time without notice to change said circuitry and specifications.