

54LS192/DM74LS192 Up/Down Decade Counter with Separate Up/Down Clocks

General Description

The 'LS192 is an up/down BCD decade (8421) counter. Separate Count Up and Count Down Clocks are used and in either counting mode the circuits operate synchronously. The outputs change state synchronous with the LOW-to-HIGH transitions on the clock inputs.

Separate Terminal Count Up and Terminal Count Down outputs are provided which are used as the clocks for a subsequent stage without extra logic, thus simplifying multistage counter designs. Individual preset inputs allow the circuits to be used as programmable counters. Both the Parallel Load (\overline{PL}) and the Master Reset (MR) inputs asynchronously override the clocks.

Connection Diagram

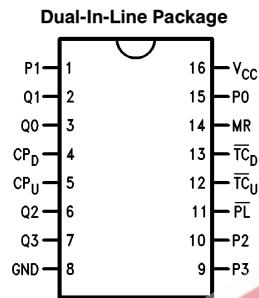

TL/F/10178-1

Order Number 54LS192DMQB, 54LS192FMQB,
54LS192LMQB, DM74LS192M or DM74LS192N
See NS Package Number E20A, J16A,
M16A, N16E or W16A

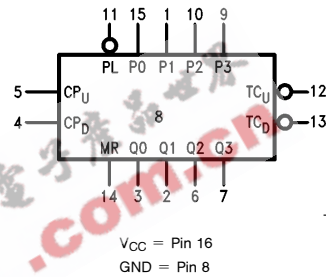

Logic Symbol



TL/F/10178-2

Pin Names	Description
CP _U	Count Up Clock Input (Active Rising Edge)
CP _D	Count Down Clock Input (Active Rising Edge)
MR	Asynchronous Master Reset Input (Active HIGH)
\overline{PL}	Asynchronous Parallel Load Input (Active LOW)
P0-P3	Parallel Data Inputs
Q0-Q3	Flip-Flop Outputs
\overline{TC}_D	Terminal Count Down (Borrow) Output (Active LOW)
\overline{TC}_U	Terminal Count Up (Carry) Output (Active LOW)

Mode Select Table

MR	\overline{PL}	CP _U	CP _D	Mode
H	X	X	X	Reset (Asyn.)
L	L	X	X	Preset (Asyn.)
L	H	H	H	No Change
L	H		H	Count Up
L	H	H		Count Down

H = HIGH Voltage Level
L = LOW Voltage Level
X = Immaterial

Absolute Maximum Ratings (Note)

If Military/Aerospace specified devices are required, please contact the National Semiconductor Sales Office/Distributors for availability and specifications.

Supply Voltage	7V
Input Voltage	7V
Operating Free Air Temperature Range	
54LS	−55°C to +125°C
DM74LS	0°C to +70°C
Storage Temperature Range	−65°C to +150°C

Note: The "Absolute Maximum Ratings" are those values beyond which the safety of the device cannot be guaranteed. The device should not be operated at these limits. The parametric values defined in the "Electrical Characteristics" table are not guaranteed at the absolute maximum ratings. The "Recommended Operating Conditions" table will define the conditions for actual device operation.

Recommended Operating Conditions

Symbol	Parameter	54LS192			DM74LS192			Units
		Min	Nom	Max	Min	Nom	Max	
V _{CC}	Supply Voltage	4.5	5	5.5	4.75	5	5.25	V
V _{IH}	High Level Input Voltage	2			2			V
V _{IL}	Low Level Input Voltage			0.7			0.8	V
I _{OH}	High Level Output Voltage			−0.4			−0.4	mA
I _{OL}	Low Level Output Current			4			8	mA
T _A	Free Air Operating Temperature	−55		125	0		70	°C
t _s (H)	Setup Time HIGH or LOW	20			20			ns
t _s (L)	Pn to \overline{PL}	20			10			ns
t _h (H)	Hold Time HIGH or LOW	3			3			ns
t _h (L)	Pn to \overline{PL}	3			3			ns
t _w (L)	CP Pulse Width LOW	17			17			ns
t _w (L)	\overline{PL} Pulse Width LOW	20			20			ns
t _w (H)	MR Pulse Width HIGH	15			15			ns
t _{rec}	Recovery Time, MR to CP	3			3			ns
t _{rec}	Recovery Time, \overline{PL} to CP	10			10			ns

Electrical Characteristics over recommended operating free air temperature range (unless otherwise noted)

Symbol	Parameter	Conditions	Min	Typ (Note 1)	Max	Units
V _I	Input Clamp Voltage	V _{CC} = Min, I _I = −18 mA			−1.5	V
V _{OH}	High Level Output Voltage	V _{CC} = Min, I _{OH} = Max, V _{IL} = Max	54LS 2.5			V
			DM74 2.7			
V _{OL}	Low Level Output Voltage	V _{CC} = Min, I _{OL} = Max, V _{IH} = Min	54LS		0.4	V
			DM74		0.5	
		I _{OL} = 4 mA, V _{CC} = Min	DM74		0.4	
I _I	Input Current @ Max Input Voltage	V _{CC} = Max, V _I = 10V V _I = 7V	DM54		0.1	mA
			DM74			
I _{IH}	High Level Input Current	V _{CC} = Max, V _I = 2.7V			20	μA
I _{IL}	Low Level Input Current	V _{CC} = Max, V _I = 0.4V			−0.4	mA
I _{OS}	Short Circuit Output Current	V _{CC} = Max (Note 2)	54LS −20		−100	mA
			DM74 −20		−100	
I _{CC}	Supply Current	V _{CC} = Max, MR, \overline{PL} = GND Other Inputs = 4.5V			31	mA

Note 1: All typicals are at V_{CC} = 5V, T_A = 25°C.

Note 2: Not more than one output should be shorted at a time, and the duration should not exceed one second.

Switching Characteristics

$V_{CC} = +0.5V$, $T_A = +25^\circ C$ (See Section 1 for waveforms and load configurations)

Symbol	Parameter	$R_L = 2k$ $C_L = 15 \text{ pF}$		Units
		Min	Max	
f_{max}	Maximum Count Frequency	30		MHz
t_{PLH} t_{PHL}	Propagation Delay CP _U or CP _D to Q _n		31 28	ns
t_{PLH} t_{PHL}	Propagation Delay CP _U to \overline{TC}_U		16 21	ns
t_{PLH} t_{PHL}	Propagation Delay CP _D to \overline{TC}_D		16 24	
t_{PLH} t_{PHL}	Propagation Delay P _n to Q _n		20 30	ns
t_{PLH} t_{PHL}	Propagation Delay \overline{PL} to Q _n		32 30	ns
t_{PHL}	Propagation Delay, MR to Q _n		25	

Functional Description

The '192 is an asynchronously presettable decade and 4-bit binary synchronous up/down (reversible) counter. The operating modes of the '192 decade counter and the '193 binary counter are identical, with the only difference being the count sequences as noted in the State Diagram. Each circuit contains four master/slave flip-flops, with internal gating and steering logic to provide master reset, individual preset, count up, and count down operations.

Each flip-flop contains JK feedback from slave to master such that a LOW-to-HIGH transition on its T input causes the slave, and thus the Q output to change state. Synchronous switching, as opposed to ripple counting, is achieved by driving the steering gates of all stages from a common Count Up line and a common Count Down line, thereby causing all state changes to be initiated simultaneously. A LOW-to-HIGH transition on the Count Up input will advance the count by one; a similar transition on the Count Down input will decrease the count by one. While counting with one clock input, the other should be held HIGH. Otherwise, the circuit will either count by twos or not at all, depending on the state of the first flip-flop, which cannot toggle as long as either Clock input is LOW.

The Terminal Count Up (\overline{TC}_U) and Terminal Count Down (\overline{TC}_D) outputs are normally HIGH. When a circuit has reached the maximum count state (9 for the '192, 15 for the '193), the next HIGH-to-LOW transition of the Count Up Clock will cause \overline{TC}_U to go LOW. \overline{TC}_U will stay LOW until CP_U goes HIGH again, thus effectively repeating the Count Up Clock, but delayed by two gate delays. Similarly, the \overline{TC}_D output will go LOW when the circuit is in the zero state and the Count Down Clock goes LOW. Since the \overline{TC} outputs repeat the clock waveforms, they can be used as the clock input signals to the next higher order circuit in a multistage counter.

$$\overline{TC}_U = Q_0 \cdot Q_3 \cdot \overline{CP}_U$$

$$\overline{TC}_D = \overline{Q_0} \cdot \overline{Q_1} \cdot \overline{Q_2} \cdot \overline{Q_3} \cdot \overline{CP}_D$$

Each circuit has an asynchronous parallel load capability permitting the counter to be reset. When the Parallel Load (\overline{PL}) and the Master Reset (MR) inputs are LOW, information present on the Parallel Data inputs (P0-P3) is loaded into the counter and appears on the outputs regardless of the conditions of the clock inputs. A HIGH signal on the Master Reset input will disable the preset gates, override both Clock inputs, and latch each Q output in the LOW state. If one of the Clock inputs is LOW during and after a reset or load operation, the next LOW-to-HIGH transition of that Clock will be interpreted as a legitimate signal and will be counted.

State Diagram

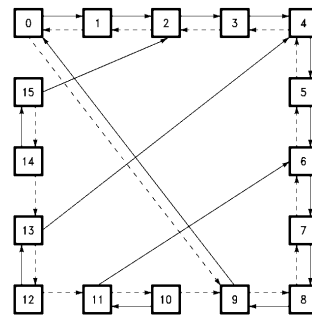

TL/F/10178-4

Logic Diagram

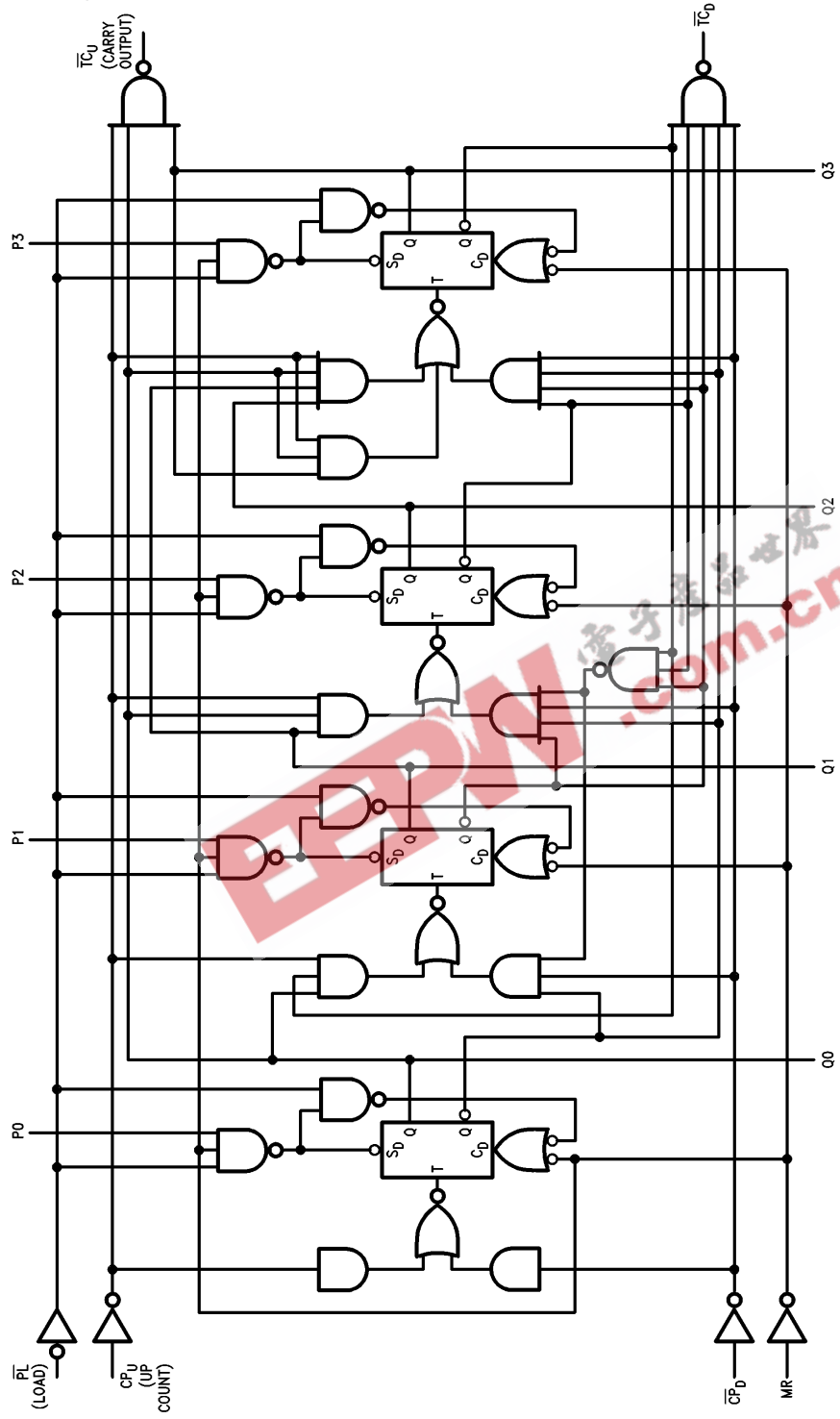

TL/F/10178-3

EEPW 电子产品世界
.com.cn

Physical Dimensions inches (millimeters)

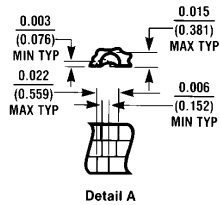
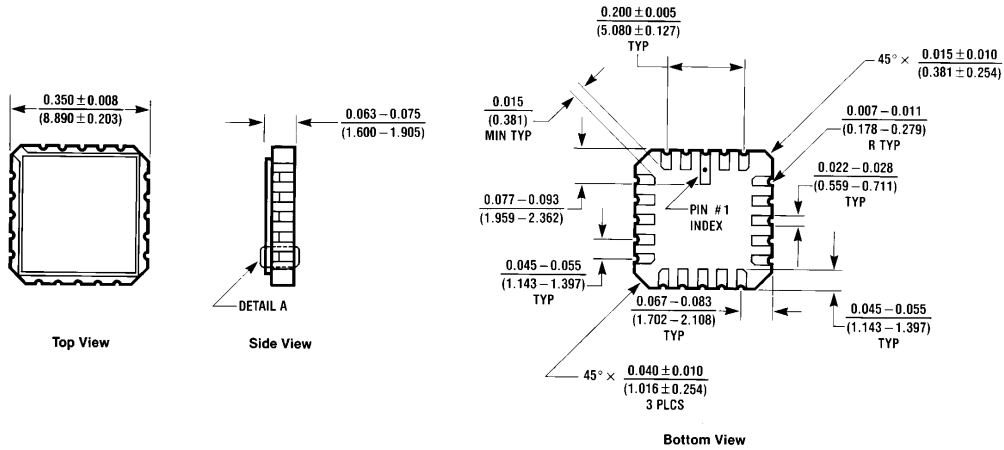

Ceramic Leadless Chip Carrier Package (E)
Order Number 54LS192LMQB
NS Package Number E20A

E20A (REV D)

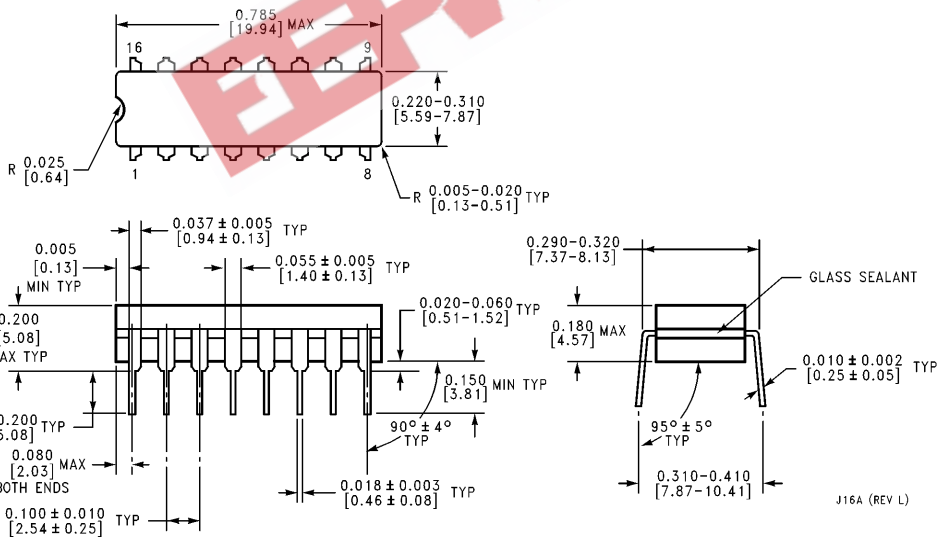

16-Lead Ceramic Dual-In-Line Package (J)
Order Number 54LS192DMQB
NS Package Number J16A

J16A (REV L)

Physical Dimensions inches (millimeters) (Continued)

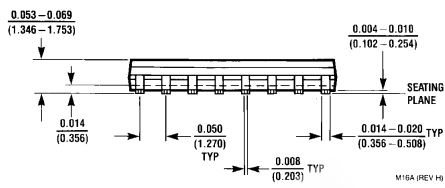
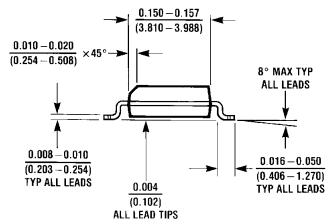
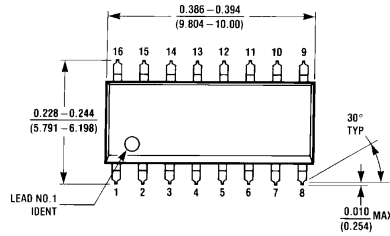

16-Lead Small Outline Molded Package (M)
Order Number DM74LS192M
NS Package Number M16A

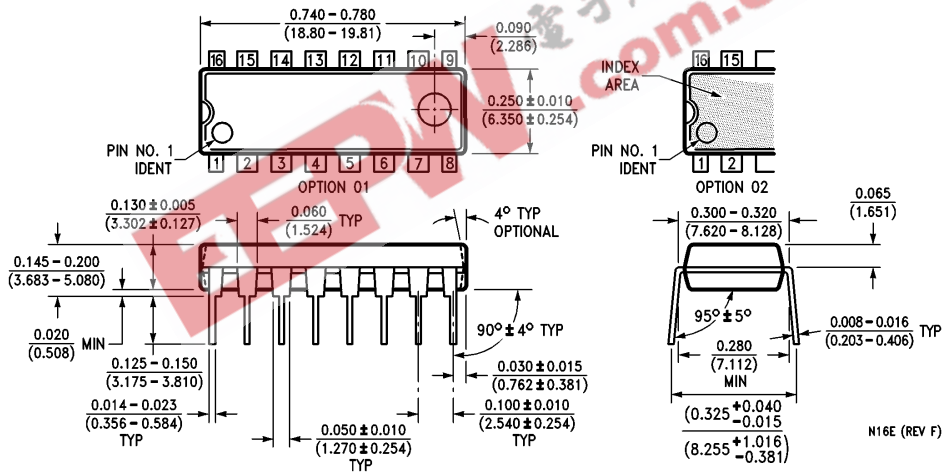

16-Lead Molded Dual-In-Line Package (N)
Order Number DM74LS192N
NS Package Number N16E

Physical Dimensions inches (millimeters) (Continued)

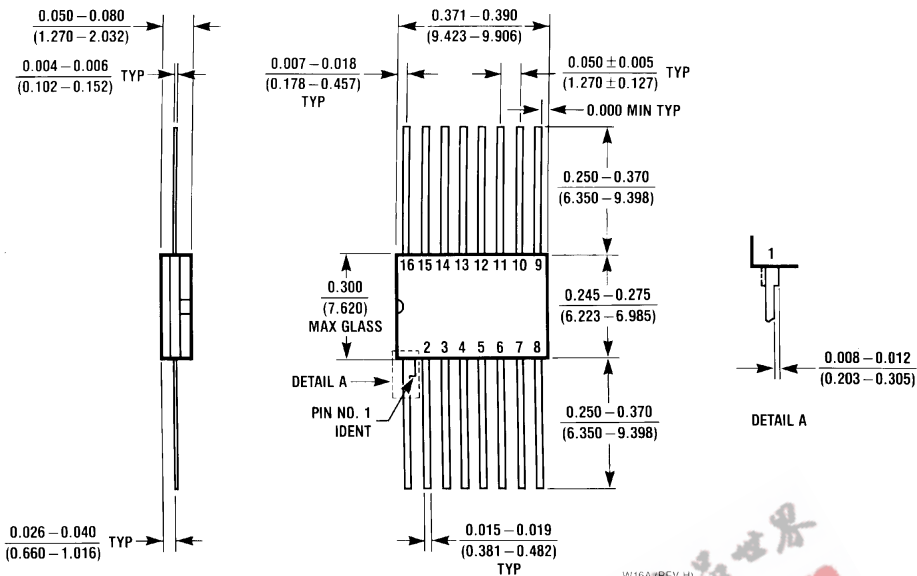

16-Lead Ceramic Flat Package (W)
Order Number 54LS192FMB
NS Package Number W16A

LIFE SUPPORT POLICY

NATIONAL'S PRODUCTS ARE NOT AUTHORIZED FOR USE AS CRITICAL COMPONENTS IN LIFE SUPPORT DEVICES OR SYSTEMS WITHOUT THE EXPRESS WRITTEN APPROVAL OF THE PRESIDENT OF NATIONAL SEMICONDUCTOR CORPORATION. As used herein:

1. Life support devices or systems are devices or systems which, (a) are intended for surgical implant into the body, or (b) support or sustain life, and whose failure to perform, when properly used in accordance with instructions for use provided in the labeling, can be reasonably expected to result in a significant injury to the user.
2. A critical component is any component of a life support device or system whose failure to perform can be reasonably expected to cause the failure of the life support device or system, or to affect its safety or effectiveness.



National Semiconductor Corporation
 1111 West Bardin Road
 Arlington, TX 76017
 Tel: 1(800) 272-9959
 Fax: 1(800) 737-7018

National Semiconductor Europe
 Fax: (+49) 0-180-530 85 86
 Email: cnjwge@levm2.nsc.com
 Deutsch Tel: (+49) 0-180-530 85 85
 English Tel: (+49) 0-180-532 78 32
 Français Tel: (+49) 0-180-532 93 58
 Italiano Tel: (+49) 0-180-534 16 80

National Semiconductor Hong Kong Ltd.
 13th Floor, Straight Block,
 Ocean Centre, 5 Canton Rd.
 Tsimshatsui, Kowloon
 Hong Kong
 Tel: (852) 2737-1600
 Fax: (852) 2736-9960

National Semiconductor Japan Ltd.
 Tel: 81-043-299-2309
 Fax: 81-043-299-2408

National does not assume any responsibility for use of any circuitry described, no circuit patent licenses are implied and National reserves the right at any time without notice to change said circuitry and specifications.