

## Dual Common-Cathode Zener Diodes

V<sub>Z</sub> Range 2.7 to 51V  
Power Dissipation 300mW

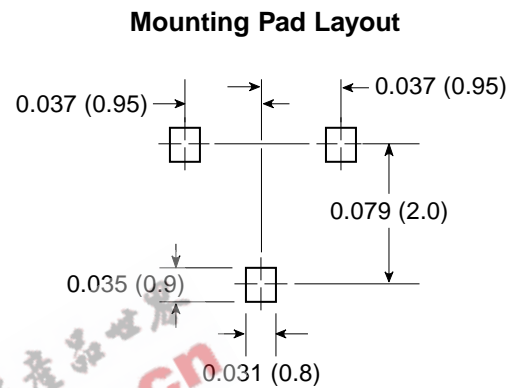

### TO-236AB (SOT-23)

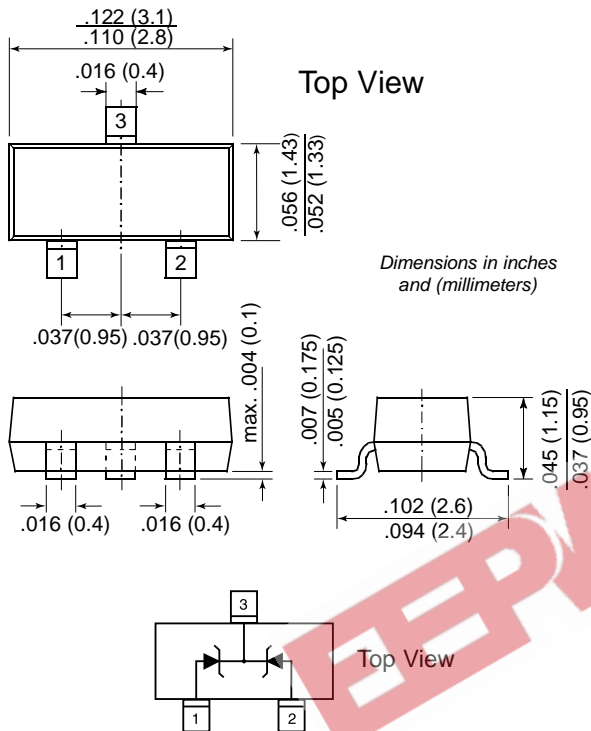

### Features

- Dual Silicon Planar Zener Diodes, Common Cathode
- The Zener voltages are graded according to the international E 24 standard. Standard Zener voltage tolerance is  $\pm 5\%$ . Replace "C" with "B" for 2% tolerance. Other voltage tolerances and other Zener voltages are available upon request.
- The parameters are valid for both diodes in one case.  $\Delta V_Z$  and  $\Delta r_{zj}$  of the two diodes in one case is  $\leq 5\%$
- This diode is also available in other case styles and configurations including: the dual diode common cathode configuration with type designation AZ23, the single diode SOT-23 case with the type designation BZX84C, and the single diode SOD-123 case with the type designation BZT52C.

### Mechanical Data

**Case:** SOT-23 Plastic Package

**Weight:** Approx. 0.008g

**Packaging Codes/Options:**

E8/10K per 13" reel (8mm tape), 30K/box  
E9/3K per 7" reel (8mm tape), 30K/box

### Maximum Ratings and Thermal Characteristics (T<sub>A</sub> = 25°C unless otherwise noted)

Parameter	Symbol	Value	Unit
Power Dissipation at T <sub>amb</sub> = 25°C	P <sub>tot</sub>	300 <sup>(1)</sup>	mW
Thermal Resistance Junction to Ambient Air	R <sub>θJA</sub>	420 <sup>(1)</sup>	°C/W
Junction Temperature	T <sub>j</sub>	150	°C
Storage Temperature Range	T <sub>S</sub>	-65 to +150	°C

**Note:**

(1) Device on fiberglass substrate, see layout

## Dual Common-Cathode Zener Diodes

### Electrical Characteristics (T<sub>A</sub> = 25°C unless otherwise noted)

Type y = C for 5% y = B for 2%	Marking	Dynamic Resistance		Temp. Coeff. of Zener Voltage at I <sub>Z</sub> = 5mA α <sub>VZ</sub> (10 <sup>-4</sup> /°C)	Reverse Voltage at I <sub>R</sub> = 100nA V <sub>R</sub> (V)
		at I <sub>Z</sub> = 5mA f = 1kHz r <sub>ZJ</sub> (Ω)	at I <sub>Z</sub> = 1mA f = 1kHz r <sub>ZJ</sub> (Ω)		
DZ23-y2V7	V1	75 (<83)	<500	-9 ... -4	-
DZ23-y3	V2	80 (<95)	<500	-9 ... -3	-
DZ23-y3V3	V3	80 (<95)	<500	-8 ... -3	-
DZ23-y3V6	V4	80 (<95)	<500	-8 ... -3	-
DZ23-y3V9	V5	80 (<95)	<500	-7 ... -3	-
DZ23-y4V3	V6	80 (<95)	<500	-6 ... -1	-
DZ23-y4V7	V7	70 (<78)	<500	-5 ... +2	-
DZ23-y5V1	V8	30 (<60)	<480	-3 ... +4	>0.8
DZ23-y5V6	V9	10 (<40)	<400	-2 ... +6	>1
DZ23-y6V2	V10	4.8 (<10)	<200	-1 ... +7	>2
DZ23-y6V8	V11	4.5 (<8)	<150	+2 ... +7	>3
DZ23-y7V5	V12	4 (<7)	<50	-3 ... +7	>5
DZ23-y8V2	V13	4.5 (<7)	<50	+4 ... +7	>6
DZ23-y9V1	V14	4.8 (<10)	<50	+5 ... +8	>7
DZ23-y10	V15	5.2 (<15)	<70	+5 ... +8	>7.5
DZ23-y11	V16	6 (<20)	<70	+5 ... +9	>8.5
DZ23-y12	V17	7 (<20)	<90	+6 ... +9	>9
DZ23-y13	V18	9 (<25)	<110	+7 ... +9	>10
DZ23-y15	V19	11 (<30)	<110	+7 ... +9	>11
DZ23-y16	V20	13 (<40)	<170	+8 ... +9.5	>12
DZ23-y18	V21	18 (<50)	<170	+8 ... +9.5	>14
DZ23-y20	V22	20 (<50)	<220	+8 ... +10	>15
DZ23-y22	V23	25 (<55)	<220	+8 ... +10	>17
DZ23-y24	V24	28 (<80)	<220	+8 ... +10	>18
DZ23-y27	V25	30 (<80)	<250	+8 ... +10	>20
DZ23-y30	V26	35 (<80)	<250	+8 ... +10	>22.5
DZ23-y33	V27	40 (<80)	<250	+8 ... +10	>25
DZ23-y36	V28	40 (<90)	<250	+8 ... +10	>27
DZ23-y39	V29	50 (<90)	<300	+10 ... +12	>29
DZ23-y43	V30	60 (<100)	<700	+10 ... +12	>32
DZ23-y47	V31	70 (<100)	<750	+10 ... +12	>35
DZ23-y51	V32	70 (<100)	<750	+10 ... +12	>38

**Note:**

(1) Tested with pulses t<sub>p</sub> = 5ms

## Dual Common-Cathode Zener Diodes

### Electrical Characteristics (T<sub>A</sub> = 25°C unless otherwise noted)

Type ± 5% Tol.	Zener Voltage range <sup>(1)</sup> at I <sub>Z</sub> V <sub>Z</sub> (V)		Test Current I <sub>Z</sub> (mA)
	min.	max.	
DZ23-C2V7	2.50	2.90	5
DZ23-C3	2.80	3.20	5
DZ23-C3V3	3.10	3.50	5
DZ23-C3V6	3.40	3.80	5
DZ23-C3V9	3.70	4.10	5
DZ23-C4V3	4.00	4.60	5
DZ23-C4V7	4.40	5.00	5
DZ23-C5V1	4.80	5.40	5
DZ23-C5V6	5.20	6.00	5
DZ23-C6V2	5.80	6.60	5
DZ23-C6V8	6.40	7.20	5
DZ23-C7V5	7.00	7.90	5
DZ23-C8V2	7.70	8.70	5
DZ23-C9V1	8.50	9.60	5
DZ23-C10	9.4	10.6	5
DZ23-C11	10.4	11.6	5
DZ23-C12	11.4	12.7	5
DZ23-C13	12.4	14.1	5
DZ23-C15	13.8	15.6	5
DZ23-C16	15.3	17.1	5
DZ23-C18	16.8	19.1	5
DZ23-C20	18.8	21.2	5
DZ23-C22	20.8	23.3	5
DZ23-C24	22.8	25.6	5
DZ23-C27	25.1	28.9	5
DZ23-C30	28.0	32.0	5
DZ23-C33	31.0	35.0	5
DZ23-C36	34.0	38.0	5
DZ23-C39	37.0	41.0	5
DZ23-C43	40.0	46.0	5
DZ23-C47	44.0	50.0	5
DZ23-C51	48.0	54.0	5

Type ± 2% Tol.	Zener Voltage range <sup>(1)</sup> at I <sub>Z</sub> V <sub>Z</sub> (V)		Test Current I <sub>Z</sub> (mA)
	min.	max.	
DZ23-B2V7	2.65	2.75	5
DZ23-B3	2.94	3.06	5
DZ23-B3V3	3.23	3.37	5
DZ23-B3V6	3.53	3.67	5
DZ23-B3V9	3.82	3.98	5
DZ23-B4V3	4.21	4.39	5
DZ23-B4V7	4.61	4.79	5
DZ23-B5V1	5.00	5.20	5
DZ23-B5V6	5.49	5.71	5
DZ23-B6V2	6.08	6.32	5
DZ23-B6V8	6.66	6.94	5
DZ23-B7V5	7.35	7.65	5
DZ23-B8V2	8.04	8.36	5
DZ23-B9V1	8.92	9.28	5
DZ23-B10	9.80	10.2	5
DZ23-B11	10.8	11.2	5
DZ23-B12	11.8	12.2	5
DZ23-B13	12.7	13.3	5
DZ23-B15	14.7	15.3	5
DZ23-B16	15.7	16.3	5
DZ23-B18	17.6	18.4	5
DZ23-B20	19.6	20.4	5
DZ23-B22	21.6	22.4	5
DZ23-B24	23.5	24.5	5
DZ23-B27	26.5	27.5	5
DZ23-B30	29.4	30.6	5
DZ23-B33	32.3	33.7	5
DZ23-B36	35.3	36.7	5
DZ23-B39	38.2	39.8	5
DZ23-B43	42.1	43.9	5
DZ23-B47	46.1	47.9	5
DZ23-B51	50.0	52.0	5

**Notes:**

(1) Measured with pulses t<sub>p</sub> = 5 ms

Dual Common-Cathode Zener Diodes

Ratings and Characteristic Curves (T<sub>A</sub> = 25°C unless otherwise noted)

Breakdown characteristics

T<sub>j</sub> = constant (pulsed)

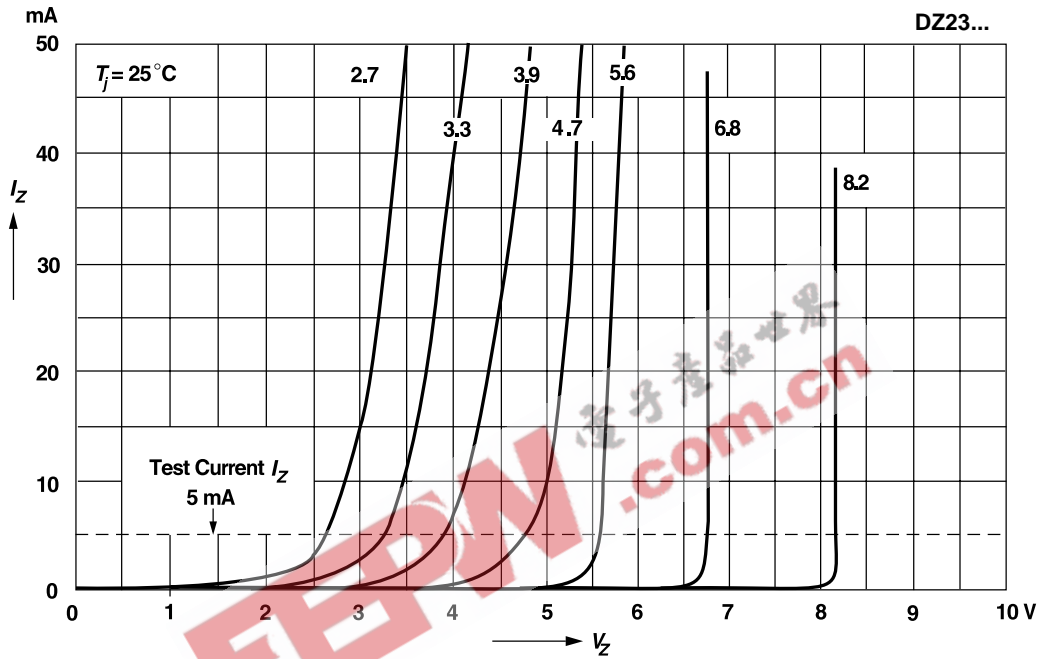

Breakdown characteristics

T<sub>j</sub> = constant (pulsed)

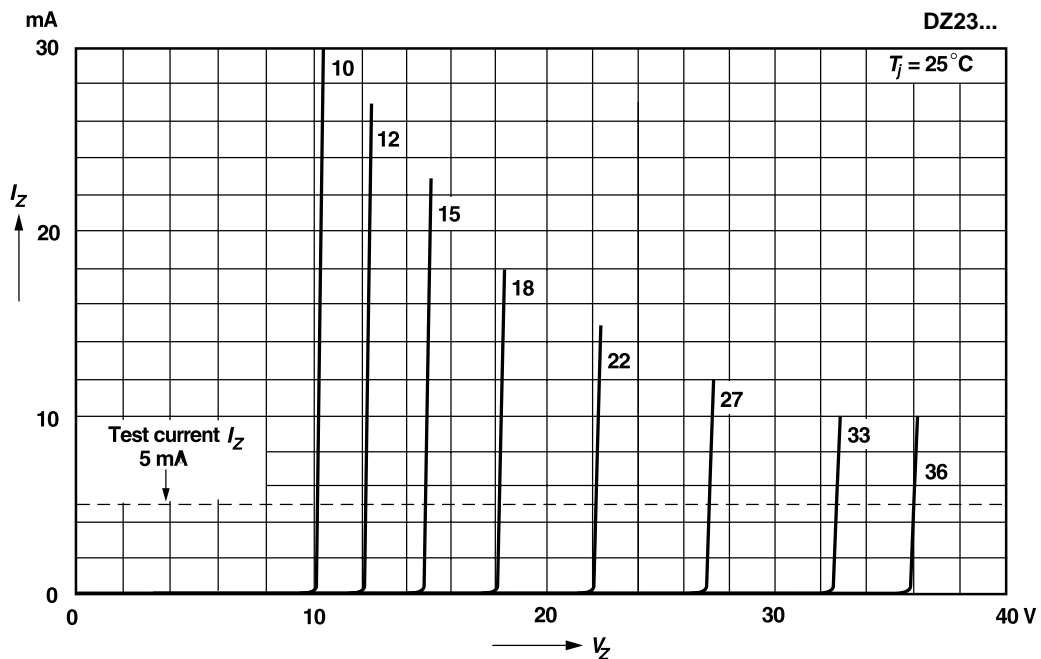

Dual Common-Cathode Zener Diodes

Ratings and Characteristic Curves (T<sub>A</sub> = 25°C unless otherwise noted)

Breakdown characteristics

T<sub>j</sub> = constant (pulsed)

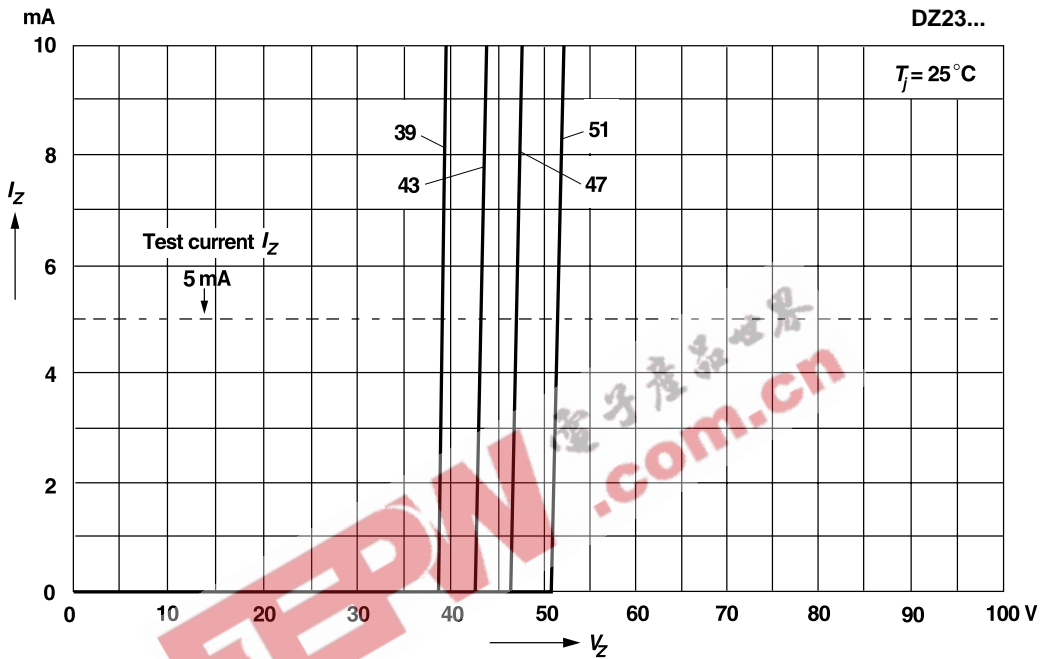

Forward characteristics

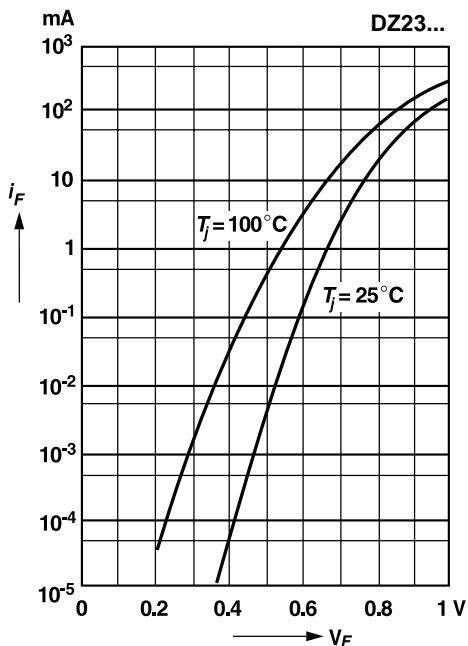

Admissible power dissipation versus ambient temperature

For conditions, see footnote in table "Absolute Maximum Ratings"

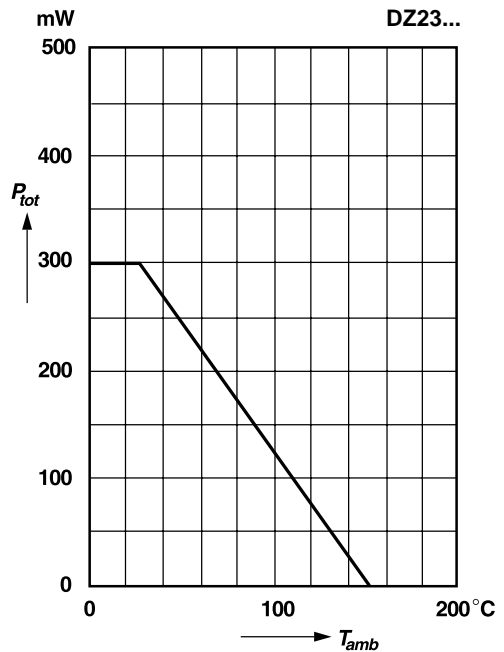

Dual Common-Cathode Zener Diodes

Ratings and Characteristic Curves (T<sub>A</sub> = 25°C unless otherwise noted)

Pulse thermal resistance versus pulse duration

For conditions, see footnote in table "Absolute Maximum Ratings"

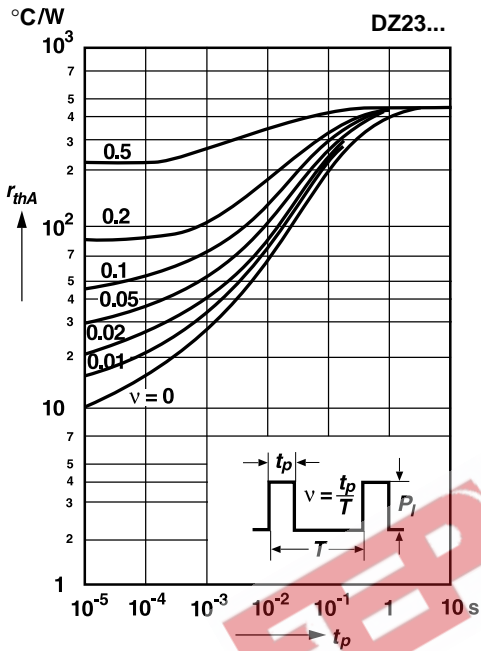

Dynamic resistance versus Zener current

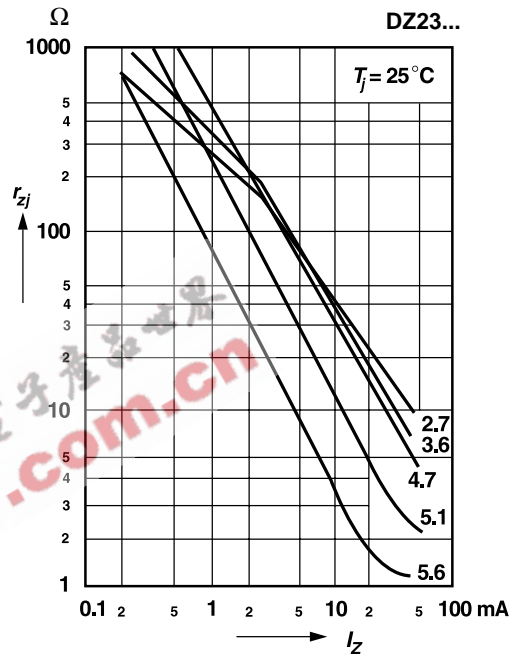

Capacitance versus Zener voltage

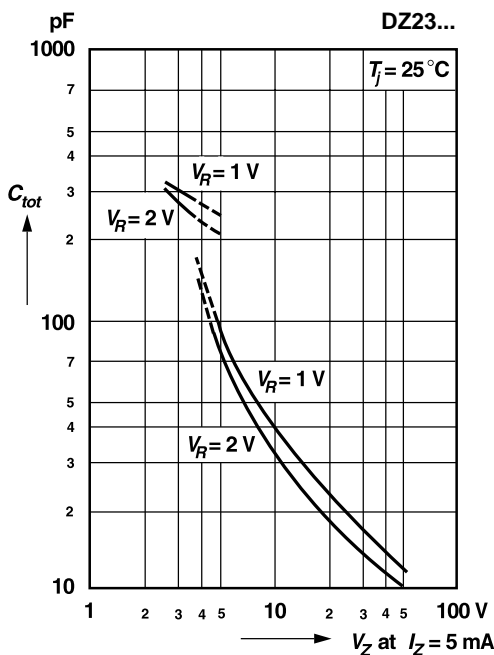

Dynamic resistance versus Zener current

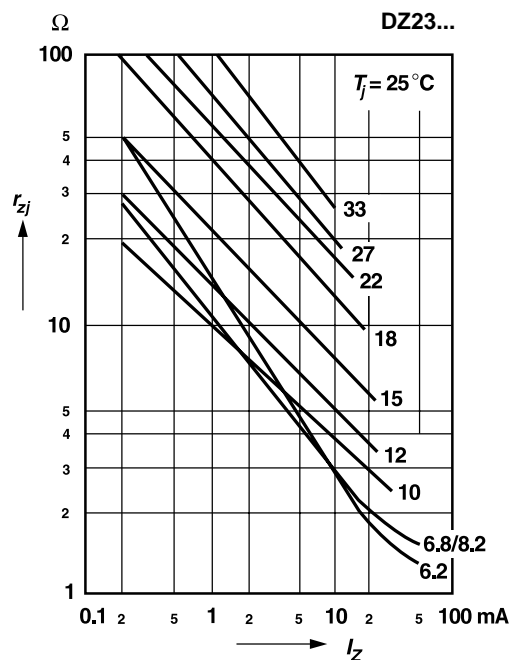

Dual Common-Cathode Zener Diodes

Ratings and Characteristic Curves (T<sub>A</sub> = 25°C unless otherwise noted)

Dynamic resistance versus Zener current

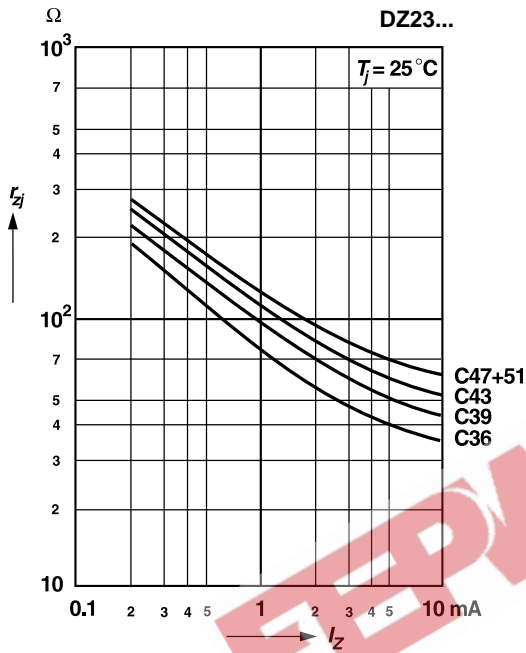

Thermal differential resistance versus Zener voltage

For conditions, see footnote in table "Absolute Maximum Ratings"

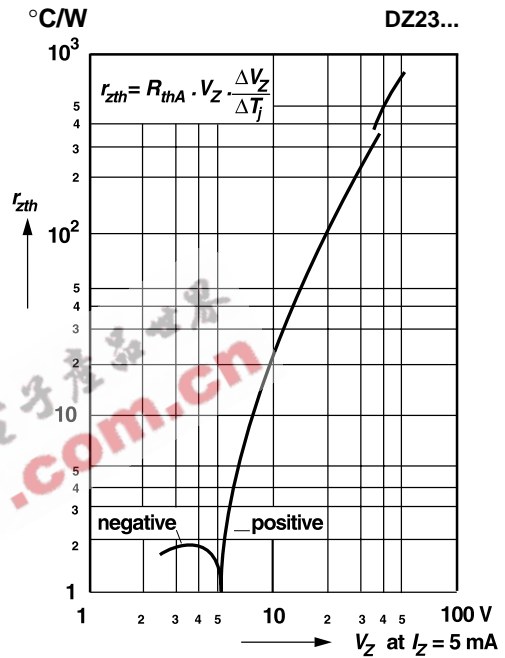

Dynamic resistance versus Zener voltage

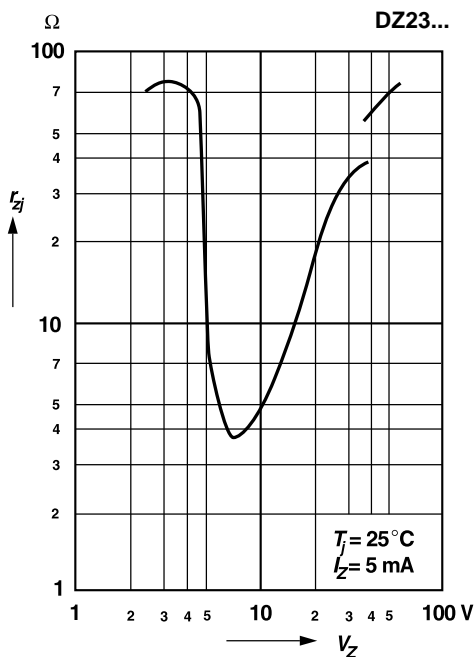

Temperature dependence of Zener voltage versus Zener voltage

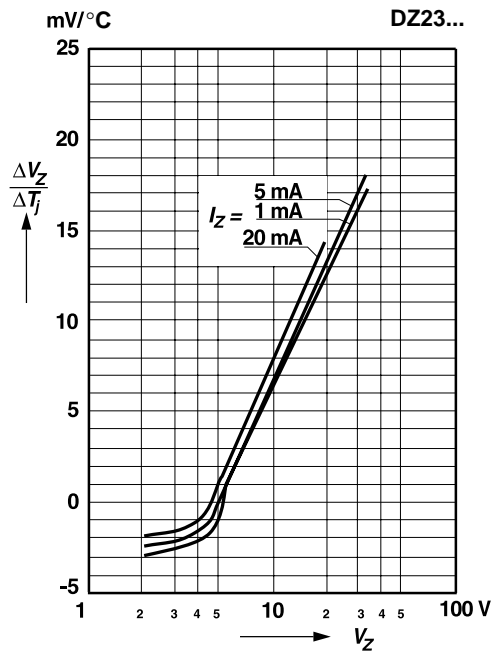

Dual Common-Cathode Zener Diodes

Ratings and Characteristic Curves (T<sub>A</sub> = 25°C unless otherwise noted)

Change of Zener voltage versus junction temperature

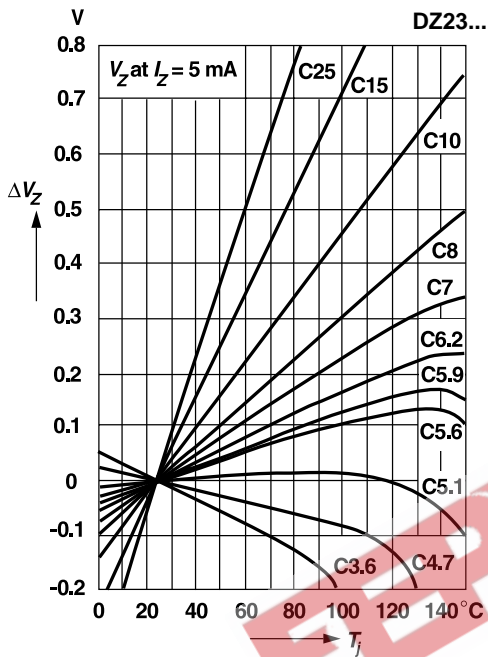

Temperature dependence of Zener voltage versus Zener voltage

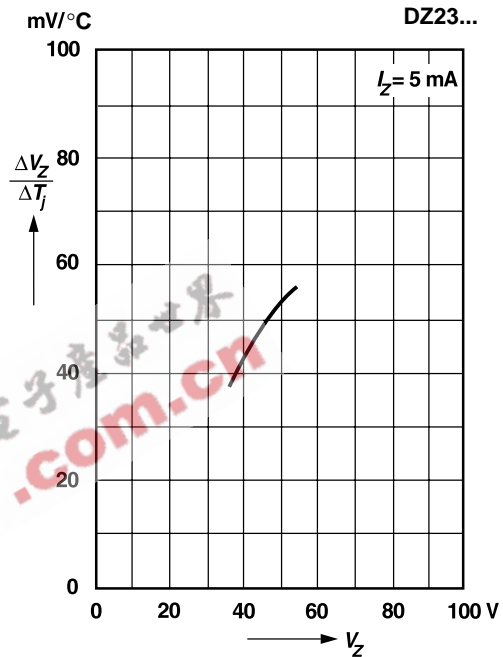

Change of Zener voltage versus junction temperature

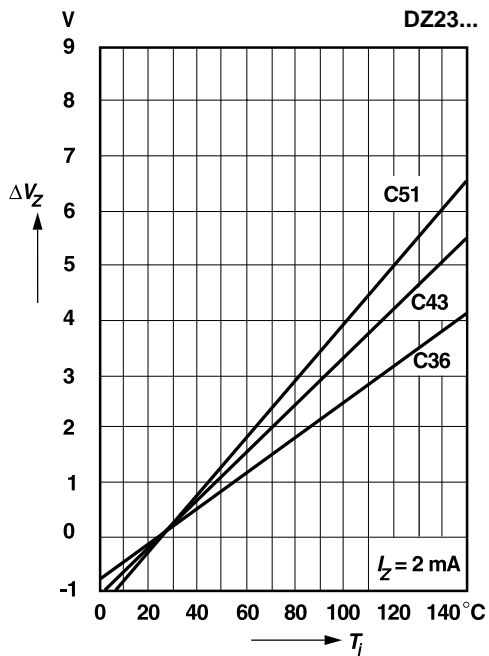

Change of Zener voltage from turn-on up to the point of thermal equilibrium versus Zener voltage

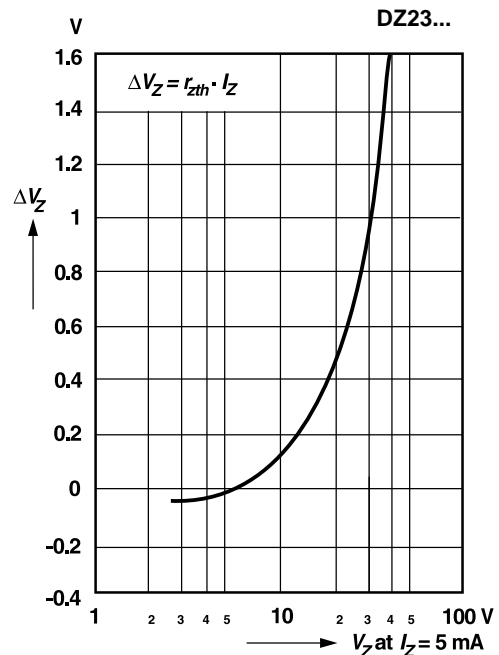



Dual Common-Cathode Zener Diodes

Ratings and Characteristic Curves (T<sub>A</sub> = 25°C unless otherwise noted)

Change of Zener voltage from turn-on up to the point of thermal equilibrium versus Zener voltage

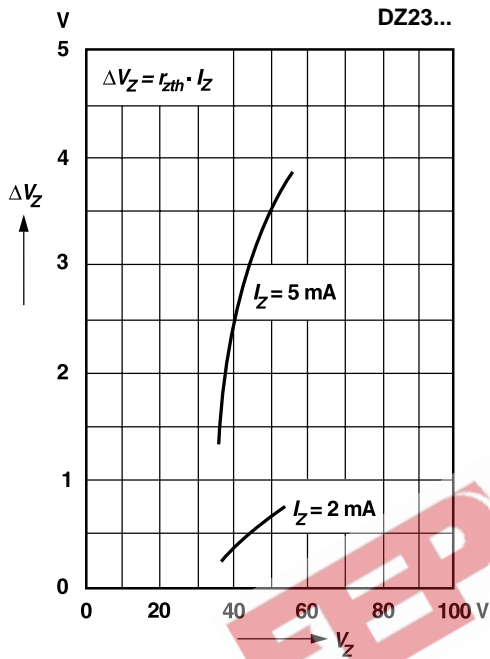

Layout for R<sub>ΘJA</sub> test

Thickness: Fiberglass 0.059 in. (1.5mm)  
Copper leads 0.012 in. (0.3mm)

