

### Features

- Dual Zeners in Common Cathode Configuration
- 300 mW Power Dissipation
- Ideally Suited for Automatic Insertion
- $V_Z$  For Both Diodes in One Case is 5%
- Common Anode Style Available
- See AZ Series
- Lead Free/RoHS Compliant (Note 3)**
- Qualified to AEC-Q101 Standards for High Reliability**

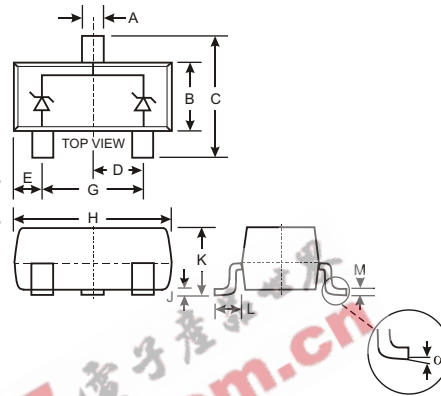

SOT-23		
Dim	Min	Max
A	0.37	0.51
B	1.20	1.40
C	2.30	2.50
D	0.89	1.03
E	0.45	0.60
G	1.78	2.05
H	2.80	3.00
J	0.013	0.10
K	0.903	1.10
L	0.45	0.61
M	0.085	0.180
	0	8
All Dimensions in mm		

### Mechanical Data

- Case: SOT-23
- Case Material: Molded Plastic. UL Flammability Classification Rating 94V-0
- Moisture Sensitivity: Level 1 per J-STD-020C
- Terminals: Solderable per MIL-STD-202, Method 208
- Lead Free Plating (Matte Tin Finish annealed over Alloy 42 leadframe).
- Polarity: See Diagram
- Marking: Marking Code (See Page 2)
- Weight: 0.008 grams (approximate)

### Maximum Ratings @ $T_A = 25^\circ\text{C}$ unless otherwise specified

Characteristic	Symbol	Value	Unit
Power Dissipation (Note 1)	$P_d$	300	mW
Thermal Resistance, Junction to Ambient Air (Note 1)	$R_{JA}$	417	$^\circ\text{C}/\text{W}$
Operating and Storage Temperature Range	$T_j, T_{STG}$	-65 to +150	$^\circ\text{C}$

Note: 1. Mounted on FR4 PC Board with recommended pad layout which can be found on our website at <http://www.diodes.com/datasheets/ap02001.pdf>.

### Ordering Information (Note 2)

Device	Packaging	Shipping
(Type Number)-7-F	SOT-23	3000/Tape & Reel

\* Add "-7-F" to the appropriate type number in Table on Page 2 example: 6.2V Zener = DZ23C6V2-7-F.

- Note: 2. For Packaging Details, go to our website at <http://www.diodes.com/datasheets/ap02007.pdf>.  
3. No purposefully added lead.

## Electrical Characteristics

@ T<sub>A</sub> = 25°C unless otherwise noted

Type Number	Marking Code	Zener Voltage Range (Note 4)	Maximum Zener Impedance (Note 5)		Typical Temperature Coefficient	Min. Reverse Voltage (Note 4)
		@ I <sub>ZT</sub> = 5.0mA	Z <sub>ZT</sub> @ I <sub>ZT</sub> = 5.0mA	Z <sub>ZK</sub> @ I <sub>ZK</sub> = 1.0mA		@ I <sub>R</sub> = 0.1μA
		V <sub>Z</sub> (Volts)	Ohms	Ohms	T <sub>C</sub> (%/°C)	V <sub>R</sub> (Volts)
DZ23C2V7	KV1	2.5-2.9	83	500	-0.065	—
DZ23C3V0	KV2	2.8-3.2	95	500	-0.060	—
DZ23C3V3	KV3	3.1-3.5	95	500	-0.055	—
DZ23C3V6	KV4	3.4-3.8	95	500	-0.055	—
DZ23C3V9	KV5	3.7-4.1	95	500	-0.050	—
DZ23C4V3	KV6	4.0-4.6	95	500	-0.035	—
DZ23C4V7	KV7	4.4-5.0	78	500	-0.015	—
DZ23C5V1	KV8	4.8-5.4	60	480	+0.005	0.8
DZ23C5V6	KV9	5.2-6.0	40	400	+0.020	1.0
DZ23C6V2	KVA	5.8-6.6	10	200	+0.030	2.0
DZ23C6V8	KVB	6.4-7.2	8.0	150	+0.045	3.0
DZ23C7V5	KVC	7.0-7.9	7.0	50	+0.050	5.0
DZ23C8V2	KVD	7.7-8.7	7.0	50	+0.055	6.0
DZ23C9V1	KVE	8.5-9.6	10	50	+0.065	7.0
DZ23C10	KVF	9.4-10.6	15	70	+0.065	7.5
DZ23C11	KVG	10.4-11.6	20	70	+0.070	8.5
DZ23C12	KVH	11.4-12.7	20	90	+0.075	9.0
DZ23C13	KVI	12.4-14.1	25	110	+0.080	10.0
DZ23C15	KVJ	13.8-15.6	30	110	+0.080	11.0
DZ23C16	KVK	15.3-17.1	40	170	+0.090	12.0
DZ23C18	KVL	16.8-19.1	50	170	+0.090	14.0
DZ23C20	KVM	18.8-21.2	50	220	+0.090	15.0
DZ23C22	KVN	20.8-23.3	55	220	+0.090	17.0
DZ23C24	KVO	22.8-25.6	80	220	+0.090	18.0
DZ23C27	KVP	25.1-28.9	80	250	+0.090	20.0
DZ23C30	KVQ	28-32	80	250	+0.090	22.5
DZ23C33	KVR	31-35	80	250	+0.090	25.0
DZ23C36	KVS	34-38	90	250	+0.090	27.0
DZ23C39	KVT	37-41	90	300	+0.110	29.0
DZ23C43	V30/KVU	40-46	100	700	+0.110	32.0
DZ23C47	V31/KVV	44-50	100	750	+0.110	35.0
DZ23C51	V32/KVW	48-54	100	750	+0.110	38.0

Note: 4. Short duration test pulse used to minimize self-heating effect.  
5. f = 1KHz.

## Marking Information

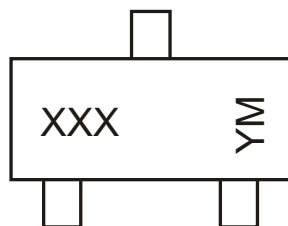

XXX = Product Type Marking Code  
YM = Date Code Marking  
Y = Year ex: N = 2002  
M = Month ex: 9 = September

Date Code Key

Year	1998	1999	2000	2001	2002	2003	2004	2005	2006	2007	2008	2009
Code	J	K	L	M	N	P	R	S	T	U	V	W

Month	Jan	Feb	March	Apr	May	Jun	Jul	Aug	Sep	Oct	Nov	Dec
Code	1	2	3	4	5	6	7	8	9	O	N	D

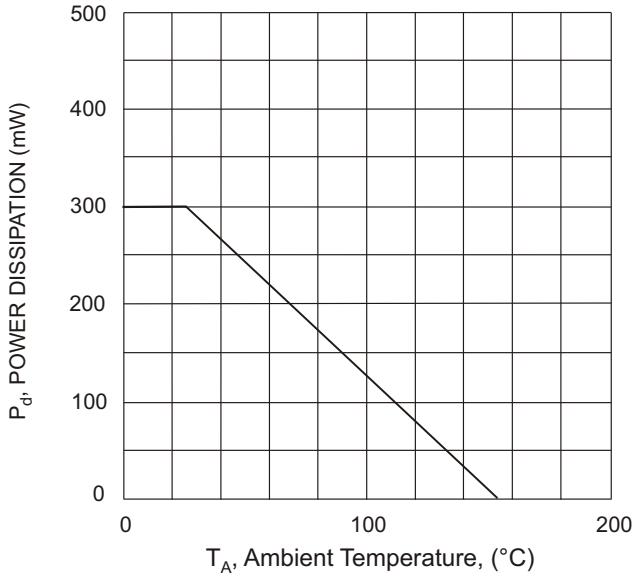

Fig. 1 Power Derating Curve

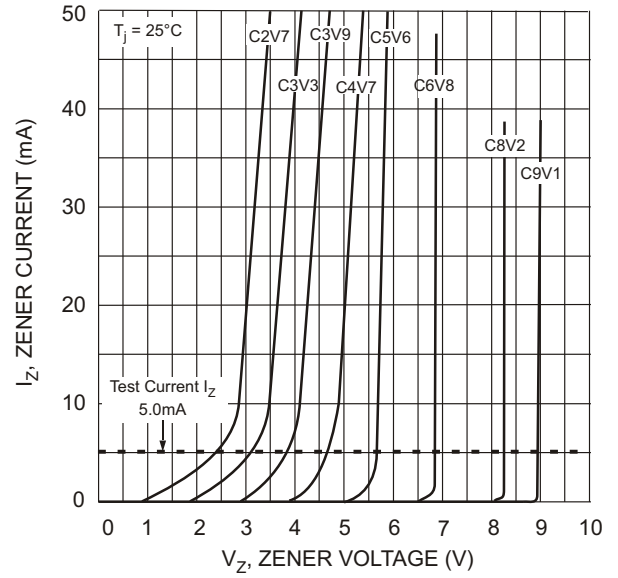

Fig. 2 Zener Breakdown Characteristics

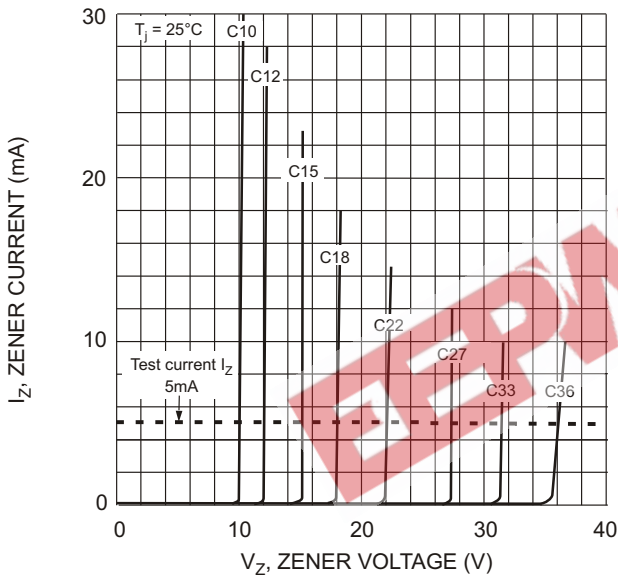

Fig. 3 Zener Breakdown Characteristics

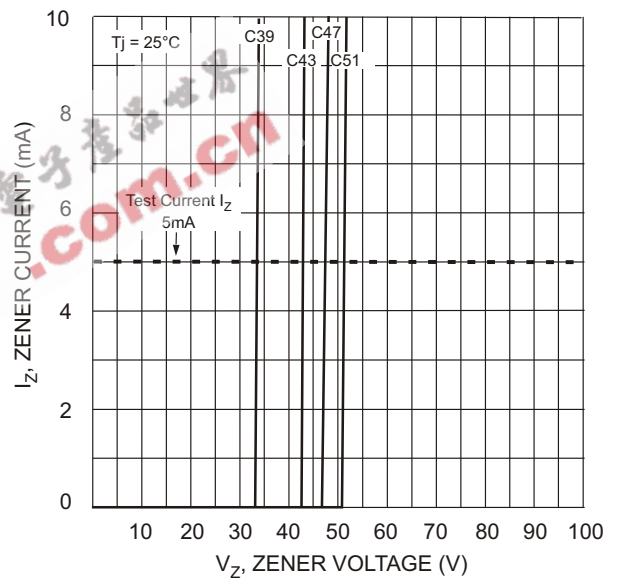

Fig. 4 Zener Breakdown Characteristics

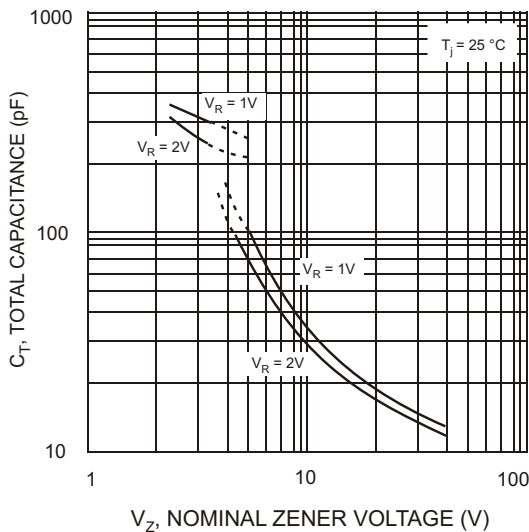

Fig. 5 Total Capacitance vs. Nominal Zener Voltage

IMPORTANT NOTICE

Diodes Incorporated and its subsidiaries reserve the right to make modifications, enhancements, improvements, corrections or other changes without further notice to any product herein. Diodes Incorporated does not assume any liability arising out of the application or use of any product described herein; neither does it convey any license under its patent rights, nor the rights of others. The user of products in such applications shall assume all risks of such use and will agree to hold Diodes Incorporated and all the companies whose products are represented on our website, harmless against all damages.

LIFE SUPPORT

Diodes Incorporated products are not authorized for use as critical components in life support devices or systems without the expressed written approval of the President of Diodes Incorporated.

EEPW 电子產品世界  
.com.cn