

Low-Voltage Quiet CMOS Octal D-Type Flip-Flop (3-State, Non-Inverting)

The MC74LVQ374 is a high performance, non-inverting octal D-type flip-flop operating from a 2.7 to 3.6V supply. The MC74LVQ374 is suitable for TTL level bus oriented applications where a memory element is required.

Current drive capability is 12mA at the outputs. The MC74LVQ374 consists of 8 edge-triggered flip-flops with individual D-type inputs and 3-state true outputs. The buffered clock and buffered Output Enable (OE) are common to all flip-flops. The eight flip-flops will store the state of individual D inputs that meet the setup and hold time requirements on the LOW-to-HIGH Clock (CP) transition. With the OE LOW, the contents of the eight flip-flops are available at the outputs. When the OE is HIGH, the outputs go to the high impedance state. The OE input level does not affect the operation of the flip-flops.

- Designed for 2.7 to 3.6V V_{CC} Operation – Ideal for Low Power/Low Noise Applications
- Guaranteed Simultaneous Switching Noise Level and Dynamic Threshold Performance
- Guaranteed Skew Specifications
- Guaranteed Incident Wave Switching into 75Ω
- Low Static Supply Current (10μA) Substantially Reduces System Power Requirements
- Latchup Performance Exceeds 500mA
- ESD Performance: Human Body Model >2000V

Pinout: 20-Lead (Top View)

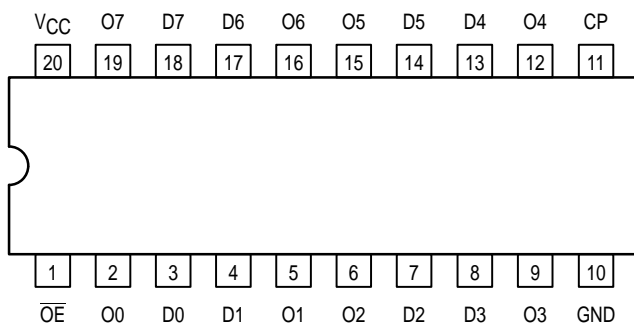

MC74LVQ374

LVQ

**LOW-VOLTAGE CMOS
OCTAL D-TYPE FLIP-FLOP**

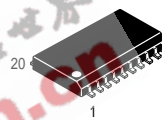

DW SUFFIX
PLASTIC SOIC
CASE 751D-04

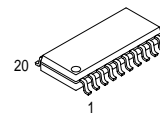

M SUFFIX
PLASTIC SOIC EIAJ
CASE 967-01

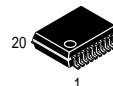

SD SUFFIX
PLASTIC SSOP
CASE 940C-03

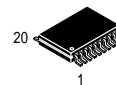

DT SUFFIX
PLASTIC TSSOP
CASE 948E-02

PIN NAMES

Pins	Function
OE	Output Enable Input
CP	Clock Pulse Input
D0-D7	Data Inputs
O0-O7	3-State Outputs



MC74LVQ374

LOGIC DIAGRAM

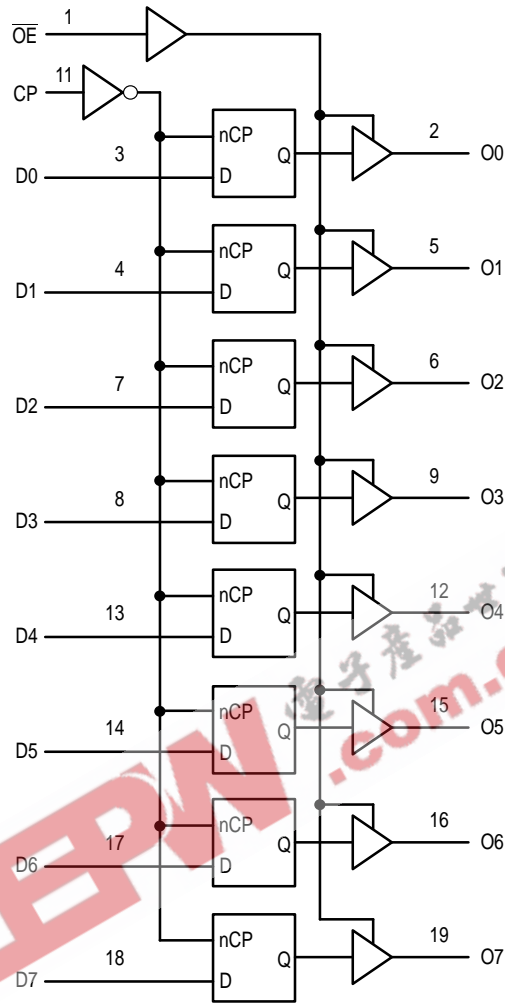

INPUTS		INTERNAL LATCHES	OUTPUTS	OPERATING MODE	
\overline{OE}	CP	Dn	Q		On
L L	\uparrow \uparrow	l h	L H	L H	Load and Read Register
L	\updownarrow	X	NC	NC	Hold and Read Register
H	\updownarrow	X	NC	Z	Hold and Disable Outputs
H H	\uparrow \uparrow	l h	L H	Z Z	Load Internal Register and Disable Outputs

H = High Voltage Level; h = High Voltage Level One Setup Time Prior to the Low-to-High Clock Transition; L = Low Voltage Level; l = Low Voltage Level One Setup Time Prior to the Low-to-High Clock Transition; NC = No Change; X = High or Low Voltage Level and Transitions are Acceptable; Z = High Impedance State; \uparrow = Low-to-High Transition; \updownarrow = Not a Low-to-High Transition; For I_{CC} Reasons DO NOT FLOAT Inputs

ABSOLUTE MAXIMUM RATINGS*

Symbol	Parameter	Value	Condition	Unit
V _{CC}	DC Supply Voltage	-0.5 to +7.0		V
V _I	DC Input Voltage	$-0.5 \leq V_I \leq V_{CC} + 0.5V$		V
V _O	DC Output Voltage	$-0.5 \leq V_O \leq V_{CC} + 0.5$	Output in HIGH or LOW State	V
I _{IK}	DC Input Diode Current	-20	V _I = -0.5V	mA
		+20	V _I = V _{CC} + 0.5V	mA
I _{OK}	DC Output Diode Current	-20	V _O = -0.5V	mA
		+20	V _I = V _{CC} + 0.5V	mA
I _O	DC Output Source/Sink Current	±50		mA
I _{CC}	DC Supply Current	±400		mA
I _{GND}	DC Ground Current	±400		mA
T _{STG}	Storage Temperature Range	-65 to +150		°C

* Absolute maximum continuous ratings are those values beyond which damage to the device may occur. Exposure to these conditions or conditions beyond those indicated may adversely affect device reliability. Functional operation under absolute-maximum-rated conditions is not implied.

RECOMMENDED OPERATING CONDITIONS

Symbol	Parameter	Min	Typ	Max	Unit
V _{CC}	Supply Voltage	2.0	3.3	3.6	V
V _I	Input Voltage	0		V _{CC}	V
V _O	Output Voltage	0		V _{CC}	V
T _A	Operating Free-Air Temperature	-40		+85	°C
ΔV/Δt	Input Transition Rise or Fall Rate, V _{IIN} from 0.8V to 2.0V, V _{CC} = 3.0V	0		125	mV/ns

DC ELECTRICAL CHARACTERISTICS

Symbol	Characteristic	Condition	T _A = -40°C to +85°C		Unit
			Min	Max	
V _{IH}	HIGH Level Input Voltage (Note 1)	2.7V ≤ V _{CC} ≤ 3.6V, V _O = 0.1V or V _{CC} - 0.1V	2.0		V
V _{IL}	LOW Level Input Voltage (Note 1)	2.7V ≤ V _{CC} ≤ 3.6V, V _O = 0.1V or V _{CC} - 0.1V		0.8	V
V _{OH}	HIGH Level Output Voltage	2.7V ≤ V _{CC} ≤ 3.6V; I _{OH} = -50μA	V _{CC} - 0.1		V
		V _{CC} = 2.7V; I _{OH} = -12mA	2.2		
		V _{CC} = 3.0V; I _{OH} = -12mA	2.48		
V _{OL}	LOW Level Output Voltage	2.7V ≤ V _{CC} ≤ 3.6V; I _{OL} = 50μA		0.1	V
		2.7V ≤ V _{CC} ≤ 3.6V; I _{OL} = 12mA		0.4	
I _I	Input Leakage Current	2.7V ≤ V _{CC} ≤ 3.6V; V _I = V _{CC} , GND		±1.0	μA
I _{OZ}	Maximum 3-State Leakage Current	V _I (\overline{OE}) = V _{IL} , V _{IH} ; V _I , V _O = V _{CC} , GND		±2.5	μA
I _{OLD}	Minimum Dynamic Output Current (Note 2)	V _{CC} = 3.6V; V _{OLD} = 0.8V Max		36	mA
		V _{CC} = 3.6V; V _{OHD} = 2.0V Min		-25	
I _{CC}	Quiescent Supply Current	2.7V ≤ V _{CC} ≤ 3.6V; V _I = V _{CC} , GND		10	μA

1. These values of V_I are used to test DC electrical characteristics only. Functional test should use V_{IH} ≥ 2.4V, V_{IL} ≤ 0.5V.
2. Incident wave switching on transmission lines with impedances as low as 75Ω for commercial temperature range is guaranteed. Maximum test duration is 2ms, one output loaded at a time.

MC74LVQ374

DYNAMIC SWITCHING CHARACTERISTICS (V_{CC} = 3.3V)

Symbol	Characteristic	Condition	T _A = +25°C			Unit
			Min	Typ	Max	
V _{OLP}	Dynamic LOW Peak Voltage (Note 1)	C _L = 50pF, V _{IH} = 3.3V, V _{IL} = 0V		0.6	1.0	V
V _{OLV}	Dynamic LOW Valley Voltage (Note 1)	C _L = 50pF, V _{IH} = 3.3V, V _{IL} = 0V		-0.5	-1.0	V
V _{IHD}	High Level Dynamic Input Voltage (Note 2)	Input-Under-Test Switching 0V to Threshold, f=1MHz		1.5	2.0	V
V _{ILD}	Low Level Dynamic Input Voltage (Note 2)	Input-Under-Test Switching 3.3V to Threshold, f=1MHz		1.5	0.8	V

- Number of outputs defined as "n". Measured with "n-1" outputs switching from HIGH-to-LOW. The remaining output is measured in the LOW state.
- Number of data inputs is defined as "n" switching, "n-1" inputs switching 0V to 3.3V.

AC CHARACTERISTICS (t_R = t_F = 2.5ns; C_L = 50pF; R_L = 500Ω)

Symbol	Parameter	Limits									Unit
		T _A = +25°C						T _A = -40°C to +85°C			
		V _{CC} = 3.0V to 3.6V			V _{CC} = 2.7V			V _{CC} = 3.0V to 3.6V		V _{CC} = 2.7V	
		Min	Typ	Max	Min	Typ	Max	Min	Max	Max	
t _{PLH}	Propagation Delay CP to On	3.0	11.0	14.0	3.0	12.0	16.0	3.0	14.5	17.5	ns
t _{PHL}	CP to On	3.0	9.5	12.0	3.0	11.0	14.0	3.0	13.5	16.0	ns
t _{PZH}	Output Enable Time to High and Low Level	3.0	8.0	10.0	3.0	9.0	11.5	3.0	10.5	12.0	ns
t _{PZL}	to High and Low Level	3.0	8.0	10.0	3.0	9.0	11.5	3.0	10.5	12.0	ns
t _{PHZ}	Output Disable Time From High and Low Level	1.0	9.0	11.5	1.0	11.0	13.0	1.0	13.0	14.0	ns
t _{PLZ}	From High and Low Level	1.0	7.0	9.0	1.0	8.5	11.0	1.0	10.0	11.5	ns
t _{OSSL}	Output-to-Output Skew (Note 1)		1.0	1.5		1.0	1.5		1.5		ns
t _{OSLH}	(Note 1)		1.0	1.5		1.0	1.5		1.5		ns

- Skew is defined as the absolute value of the difference between the actual propagation delay for any two separate outputs of the same device. The specification applies to any outputs switching in the same direction, either HIGH-to-LOW (t_{OSSL}) or LOW-to-HIGH (t_{OSLH}); parameter guaranteed by design.

AC OPERATING REQUIREMENTS (t_R = t_F = 2.5ns; C_L = 50pF; R_L = 500Ω)

Symbol	Parameter	Limits				Unit
		T _A = +25°C		T _A = -40°C to +85°C		
		V _{CC} = 3.0V to 3.6V		V _{CC} = 2.7V		
		Min	Min	Min	Min	
t _s	Setup Time, HIGH or LOW Dn to CP	3.0	4.0	3.0	4.5	ns
t _h	Hold Time, HIGH or LOW Dn to CP	1.5	1.5	1.5	1.5	ns
t _w	CP Pulse Width, HIGH or LOW	4.0	5.0	4.0	6.0	ns

CAPACITIVE CHARACTERISTICS

Symbol	Parameter	Condition	Typical	Unit
C _{PD}	Power Dissipation Capacitance	10MHz, V _{CC} = 3.3V, V _I = 0V or V _{CC}	25	pF
C _{IN}	Input Capacitance	V _{CC} = Open, V _I = 0V or V _{CC}	4.5	pF

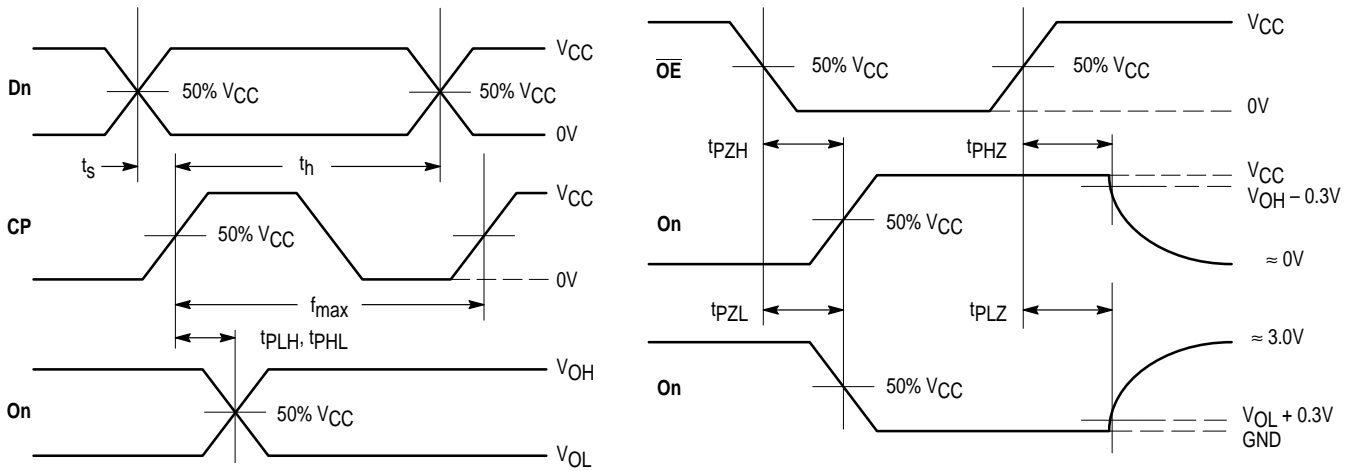

WAVEFORM 1 – PROPAGATION DELAYS, SETUP AND HOLD TIMES
 $t_R = t_F = 2.5\text{ns}$, 10% to 90%; $f = 1\text{MHz}$; $t_W = 500\text{ns}$

WAVEFORM 2 – OUTPUT ENABLE AND DISABLE TIMES
 $t_R = t_F = 2.5\text{ns}$, 10% to 90%; $f = 1\text{MHz}$; $t_W = 500\text{ns}$

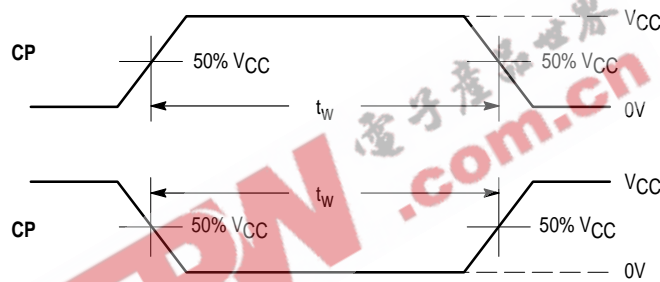

WAVEFORM 3 – PULSE WIDTH
 $t_R = t_F = 2.5\text{ns}$ (or fast as required) from 10% to 90%;
 Output requirements: $V_{OL} \leq 0.8\text{V}$, $V_{OH} \geq 2.0\text{V}$

Figure 1. AC Waveforms

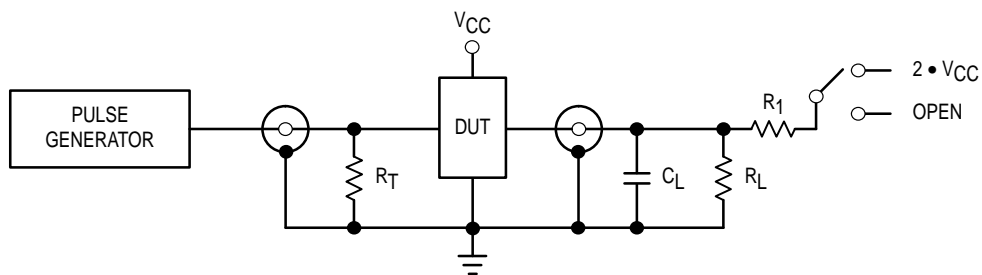

TEST	SWITCH
t_{PLH} , t_{PHL}	Open
t_{PZL} , t_{PLZ}	$2 \cdot V_{CC}$
Open Collector/Drain t_{PLH} and t_{PHL}	$2 \cdot V_{CC}$
t_{PZH} , t_{PHZ}	Open

$C_L = 50\text{pF}$ or equivalent (Includes jig and probe capacitance)
 $R_L = R_1 = 500\Omega$ or equivalent
 $R_T = Z_{OUT}$ of pulse generator (typically 50Ω)

Figure 2. Test Circuit

OUTLINE DIMENSIONS

DW SUFFIX
PLASTIC SOIC PACKAGE
CASE 751D-04
ISSUE E

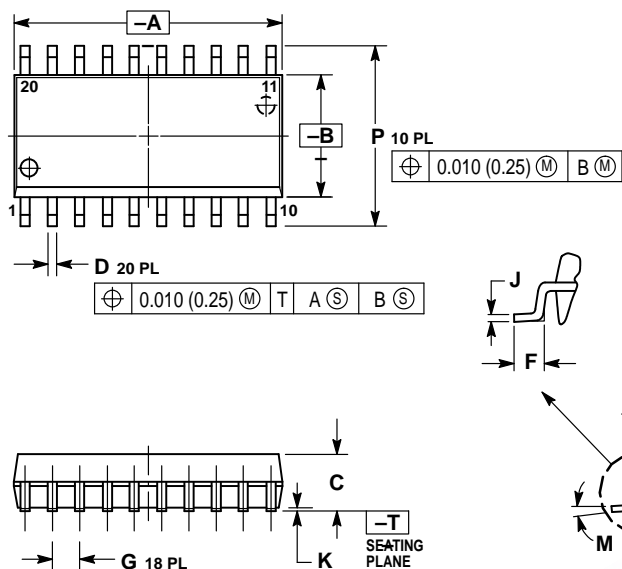

- NOTES:
1. DIMENSIONING AND TOLERANCING PER ANSI Y14.5M, 1982.
 2. CONTROLLING DIMENSION: MILLIMETER.
 3. DIMENSIONS A AND B DO NOT INCLUDE MOLD PROTRUSION.
 4. MAXIMUM MOLD PROTRUSION 0.150 (0.006) PER SIDE.
 5. DIMENSION D DOES NOT INCLUDE DAMBAR PROTRUSION. ALLOWABLE DAMBAR PROTRUSION SHALL BE 0.13 (0.005) TOTAL IN EXCESS OF D DIMENSION AT MAXIMUM MATERIAL CONDITION.

DIM	MILLIMETERS		INCHES	
	MIN	MAX	MIN	MAX
A	12.65	12.95	0.499	0.510
B	7.40	7.60	0.292	0.299
C	2.35	2.65	0.093	0.104
D	0.35	0.49	0.014	0.019
F	0.50	0.90	0.020	0.035
G	1.27 BSC		0.050 BSC	
J	0.25	0.32	0.010	0.012
K	0.10	0.25	0.004	0.009
M	0°	7°	0°	7°
P	10.05	10.55	0.395	0.415
R	0.25	0.75	0.010	0.029

M SUFFIX
PLASTIC SOIC EIAJ PACKAGE
CASE 967-01
ISSUE O

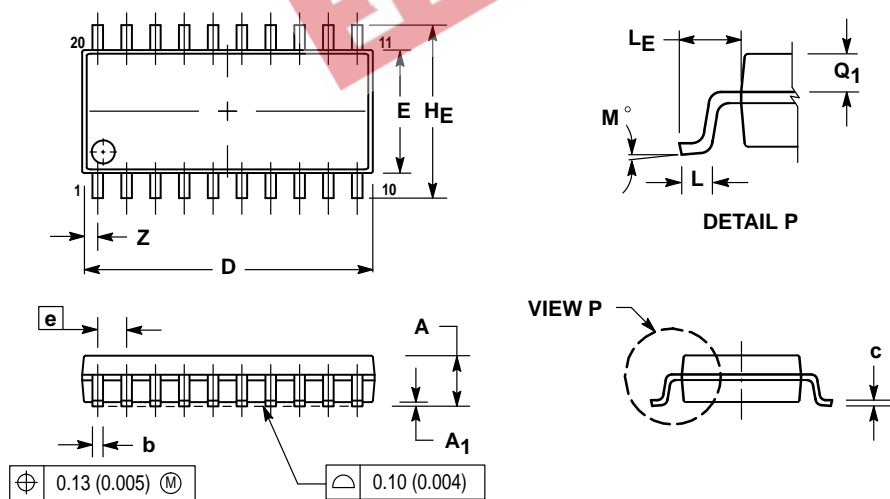

- NOTES:
1. DIMENSIONING AND TOLERANCING PER ANSI Y14.5M, 1982.
 2. CONTROLLING DIMENSION: MILLIMETER.
 3. DIMENSIONS D AND E DO NOT INCLUDE MOLD FLASH OR PROTRUSIONS AND ARE MEASURED AT THE PARTING LINE. MOLD FLASH OR PROTRUSIONS SHALL NOT EXCEED 0.15 (0.006) PER SIDE.
 4. TERMINAL NUMBERS ARE SHOWN FOR REFERENCE ONLY.
 5. THE LEAD WIDTH DIMENSION (b) DOES NOT INCLUDE DAMBAR PROTRUSION. ALLOWABLE DAMBAR PROTRUSION SHALL BE 0.08 (0.003) TOTAL IN EXCESS OF THE LEAD WIDTH DIMENSION AT MAXIMUM MATERIAL CONDITION. DAMBAR CANNOT BE LOCATED ON THE LOWER RADIUS OR THE FOOT. MINIMUM SPACE BETWEEN PROTRUSIONS AND ADJACENT LEAD TO BE 0.46 (0.018).

DIM	MILLIMETERS		INCHES	
	MIN	MAX	MIN	MAX
A	---	2.05	---	0.081
A ₁	0.05	0.20	0.002	0.008
b	0.35	0.50	0.014	0.020
c	0.18	0.27	0.007	0.011
D	12.35	12.80	0.486	0.504
E	5.10	5.45	0.201	0.215
e	1.27 BSC		0.050 BSC	
HE	7.40	8.20	0.291	0.323
L	0.50	0.85	0.020	0.033
LE	1.10	1.50	0.043	0.059
M	0°	10°	0°	10°
Q ₁	0.70	0.90	0.028	0.035
Z	---	0.81	---	0.032

OUTLINE DIMENSIONS

SD SUFFIX
 PLASTIC SSOP PACKAGE
 CASE 940C-03
 ISSUE B

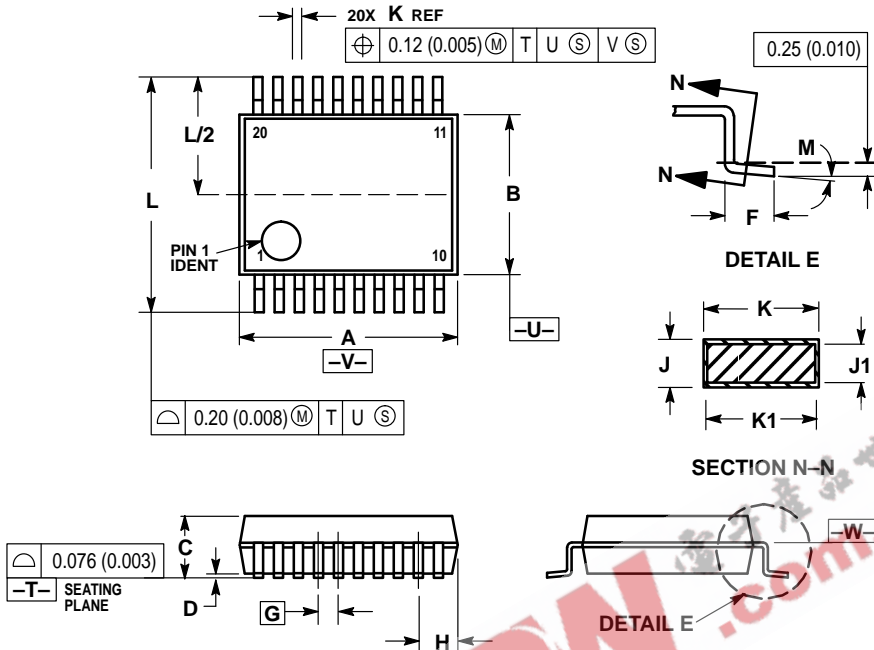

NOTES:

- 13 DIMENSIONING AND TOLERANCING PER ANSI Y14.5M, 1982.
- 14 CONTROLLING DIMENSION: MILLIMETER.
- 15 DIMENSION A DOES NOT INCLUDE MOLD FLASH, PROTRUSIONS OR GATE BURRS. MOLD FLASH OR GATE BURRS SHALL NOT EXCEED 0.15 (0.006) PER SIDE.
- 16 DIMENSION B DOES NOT INCLUDE INTERLEAD FLASH OR PROTRUSION. INTERLEAD FLASH OR PROTRUSION SHALL NOT EXCEED 0.15 (0.006) PER SIDE.
- 17 DIMENSION K DOES NOT INCLUDE DAMBAR PROTRUSION/INTRUSION. ALLOWABLE DAMBAR PROTRUSION SHALL BE 0.13 (0.005) TOTAL IN EXCESS OF K DIMENSION AT MAXIMUM MATERIAL CONDITION. DAMBAR INTRUSION SHALL NOT REDUCE DIMENSION K BY MORE THAN 0.07 (0.002) AT LEAST MATERIAL CONDITION.
- 18 TERMINAL NUMBERS ARE SHOWN FOR REFERENCE ONLY.
- 19 DIMENSION A AND B ARE TO BE DETERMINED AT DATUM PLANE -W-.

DIM	MILLIMETERS		INCHES	
	MIN	MAX	MIN	MAX
A	7.07	7.33	0.278	0.288
B	5.20	5.38	0.205	0.212
C	1.73	1.99	0.068	0.078
D	0.05	0.21	0.002	0.008
F	0.63	0.95	0.024	0.037
G	0.65 BSC		0.026 BSC	
H	0.59	0.75	0.023	0.030
J	0.09	0.20	0.003	0.008
J1	0.09	0.16	0.003	0.006
K	0.25	0.38	0.010	0.015
K1	0.25	0.33	0.010	0.013
L	7.65	7.90	0.301	0.311
M	0°	8°	0°	8°

DT SUFFIX
 PLASTIC TSSOP PACKAGE
 CASE 948E-02
 ISSUE A

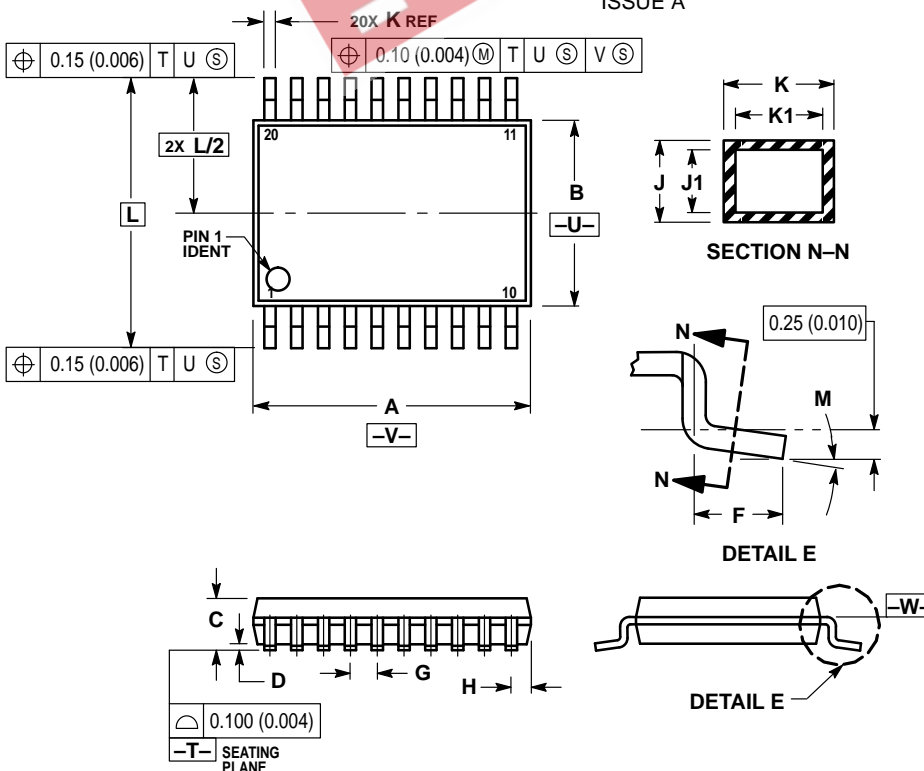

NOTES:

- 6 DIMENSIONING AND TOLERANCING PER ANSI Y14.5M, 1982.
- 7 CONTROLLING DIMENSION: MILLIMETER.
- 8 DIMENSION A DOES NOT INCLUDE MOLD FLASH, PROTRUSIONS OR GATE BURRS. MOLD FLASH OR GATE BURRS SHALL NOT EXCEED 0.15 (0.006) PER SIDE.
- 9 DIMENSION B DOES NOT INCLUDE INTERLEAD FLASH OR PROTRUSION. INTERLEAD FLASH OR PROTRUSION SHALL NOT EXCEED 0.25 (0.010) PER SIDE.
- 10 DIMENSION K DOES NOT INCLUDE DAMBAR PROTRUSION. ALLOWABLE DAMBAR PROTRUSION SHALL BE 0.08 (0.003) TOTAL IN EXCESS OF THE K DIMENSION AT MAXIMUM MATERIAL CONDITION.
- 11 TERMINAL NUMBERS ARE SHOWN FOR REFERENCE ONLY.
- 12 DIMENSION A AND B ARE TO BE DETERMINED AT DATUM PLANE -W-.

DIM	MILLIMETERS		INCHES	
	MIN	MAX	MIN	MAX
A	6.40	6.60	0.252	0.260
B	4.30	4.50	0.169	0.177
C	—	1.20	—	0.047
D	0.05	0.15	0.002	0.006
F	0.50	0.75	0.020	0.030
G	0.65 BSC		0.026 BSC	
H	0.27	0.37	0.011	0.015
J	0.09	0.20	0.004	0.008
J1	0.09	0.16	0.004	0.006
K	0.19	0.30	0.007	0.012
K1	0.19	0.25	0.007	0.010
L	6.40 BSC		0.252 BSC	
M	0°	8°	0°	8°

MC74LVQ374

EEPW 电子产品世界
.com.cn

Motorola reserves the right to make changes without further notice to any products herein. Motorola makes no warranty, representation or guarantee regarding the suitability of its products for any particular purpose, nor does Motorola assume any liability arising out of the application or use of any product or circuit, and specifically disclaims any and all liability, including without limitation consequential or incidental damages. "Typical" parameters can and do vary in different applications. All operating parameters, including "Typicals" must be validated for each customer application by customer's technical experts. Motorola does not convey any license under its patent rights nor the rights of others. Motorola products are not designed, intended, or authorized for use as components in systems intended for surgical implant into the body, or other applications intended to support or sustain life, or for any other application in which the failure of the Motorola product could create a situation where personal injury or death may occur. Should Buyer purchase or use Motorola products for any such unintended or unauthorized application, Buyer shall indemnify and hold Motorola and its officers, employees, subsidiaries, affiliates, and distributors harmless against all claims, costs, damages, and expenses, and reasonable attorney fees arising out of, directly or indirectly, any claim of personal injury or death associated with such unintended or unauthorized use, even if such claim alleges that Motorola was negligent regarding the design or manufacture of the part. Motorola and  are registered trademarks of Motorola, Inc. Motorola, Inc. is an Equal Opportunity/Affirmative Action Employer.

How to reach us:

USA/EUROPE: Motorola Literature Distribution;
P.O. Box 20912; Phoenix, Arizona 85036. 1-800-441-2447

JAPAN: Nippon Motorola Ltd.; Tatsumi-SPD-JLDC, Toshikatsu Otsuki,
6F Seibu-Butsuryu-Center, 3-14-2 Tatsumi Koto-Ku, Tokyo 135, Japan. 03-3521-8315

MFAX: RMFAX0@email.sps.mot.com -TOUCHTONE (602) 244-6609
INTERNET: <http://Design-NET.com>

HONG KONG: Motorola Semiconductors H.K. Ltd.; 8B Tai Ping Industrial Park,
51 Ting Kok Road, Tai Po, N.T., Hong Kong. 852-26629298



MC74LVQ374/D

