

# E Rated Medium Voltage Fuses

## Current Limiting

“E” Rated fuses have time current characteristics designed to provide current limiting protection for power transformers, potential transformers, power centers, feeder centers, and unit sub stations. When properly applied, they can protect against high and low value fault currents.

NEMA Standards for “E” rated medium voltage fuses require that fuses rated 100E or less open within 300 seconds (5 minutes) when subjected to an RMS value of 200-240% of the fuse’s continuous current rating; and fuses with an “E” rating larger than 100E must open within 600 seconds (10 minutes) when subjected to an rms current of 220-240% of the fuse’s continuous current rating. These values establish one point on the time-current curve.

### Application Note:

Since these fuses are used for the protection of general purpose circuits which may contain transformers, motors, and other equipment producing inrush and/or overload currents, fuses should generally be rated at 140% of the normal full load current, and circuits should be analyzed to ensure that system load currents will not exceed the current rating of the fuse.

### CHARACTERISTICS

**Voltage Rating:** 2,400 volts – 38,000 volts

**Current Range:** 10E – 600E

### OPTIONS

- Hermetically Sealed for use in hazardous locations (add “S” suffix to part number)
- Clip-lock (CL) and bolt-in styles available.

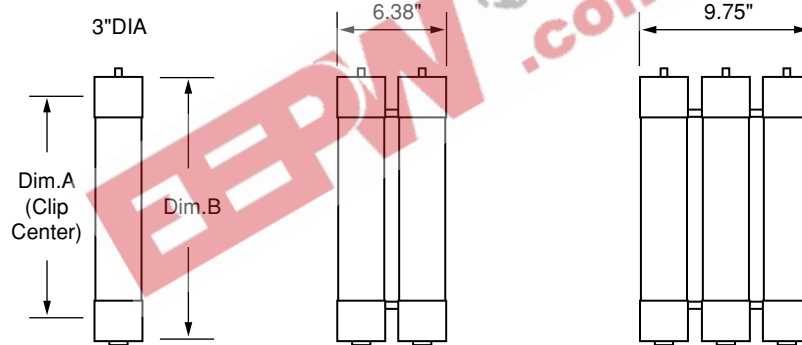

FIGURE 14

FIGURE 15

FIGURE 16

<b>RATED</b>	<b>Catalog Number</b>	<b>Old Catalog Number</b>	<b>Size</b>	<b>Dim. A (inches)</b>	<b>Dim. B (inches)</b>	<b>Max Interrupting Rating RMS (Asym)</b>	<b>Figure Number</b>
<b>2.75 Max. KV</b>	10E-1C-2.75	LCX 10E	10E	7"	10.875"	80,000	14
	15E-1C-2.75	—	15E				14
	20E-1C-2.75	—	20E				14
	25E-1C-2.75	—	25E				14
	30E-1C-2.75	LCX 30E	30E				14
	40E-1C-2.75	LCX 40E	40E				14
	50E-1C-2.75	LCX 50E	50E				14
	65E-1C-2.75	LCX 65E	65E				14
	80E-1C-2.75	LCX 80E	80E				14
	100E-1C-2.75	LCX 100E	100E				14
	125E-1C-2.75	—	125E				14
	150E-1C-2.75	—	150E				14
	200E-1C-2.75	—	200E				14
	125E-2C-2.75	LCX 125E	125E				7"
	150E-2C-2.75	LCX 150E	150E	15			
	175E-2C-2.75	LCX 175E	175E	15			
	200E-2C-2.75	LCX 200E	200E	15			
	225E-2C-2.75	—	225E	15			
	250E-2C-2.75	LCX 250E	250E	15			
	300E-2C-2.75	LCX 300E	300E	15			
	350E-2C-2.75	—	350E	15			
	400E-2C-2.75	LCX 400E	400E	15			
	450E-2C-2.75	—	450E	15			



# E Rated Medium Voltage Fuses

Current Limiting

<b>E</b> RATED	Catalog Number	Old Catalog Number	Size	Dim. A (inches)	Dim. B (inches)	Max Interrupting Rating RMS (Asym)	Diagram	
5.5 Max. KV	10E-1C-5.5	—	10E	12"	15.875"	80,000	14	
	15E-1C-5.5	—	15E				14	
	20E-1C-5.5	—	20E				14	
	25E-1C-5.5	—	25E				14	
	30E-1C-5.5	LCY 30E	30E				14	
	40E-1C-5.5	LCY 40E	40E				14	
	50E-1C-5.5	LCY 50E	50E				14	
	65E-1C-5.5	LCY 60E	65E				14	
	80E-1C-5.5	LCY 80E	80E				14	
	100E-1C-5.5	LCY 100E	100E				14	
	125E-1C-5.5	LCY 125E	125E				14	
	150E-1C-5.5	LCY 150E	150E				14	
	175E-1C-5.5	LCY 175E	175E				14	
	200E-1C-5.5	LCY 200E	200E				14	
	125E-2C-5.5	—	125E				12"	15.875"
	150E-2C-5.5	—	150E	15				
	175E-2C-5.5	—	175E	15				
	200E-2C-5.5	—	200E	15				
	250E-2C-5.5	LCY 250E	250E	15				
	300E-2C-5.5	LCY 300E	300E	15				
	350E-2C-5.5	LCY 350E	350E	15				
	400E-2C-5.5	LCY 400E	400E	15				
	450E-2C-5.5	LCY 450E	450E	15				
	500E-3C-5.5	—	500E	12"	15.875"	80,000	16	
	550E-3C-5.5	—	550E				16	
	600E-3C-5.5	—	660E				16	
	5.5 Max. KV	5NLE-10E	LCU 30E	10E	14	17-7/8"	80,000	14
		5NLE-15E		15E				14
		5NLE-20E		20E				14
		5NLE-25E		25E				14
		5NLE-30E		30E				14
		5NLE-40E		40E				14
		5NLE-50E		50E				14
5NLE-65E		65E		14				
5NLE-80E		80E		14				
5NLE-100E		100E		14				
5NLE-125E		125E		14				
5NLE-150E		150E		14				
5NLE-175E		175E		14				
5NLE-200E		200E		14				
5NLE2-225E		LCU 250E		225E				14"
5NLE2-250E		LCU 300E	250E	15				
5NLE2-300E		LCU 350E	300E	15				
5NLE2-350E		LCU 400E	350E	15				
5NLE2-400E		LCU 450E	400E	15				
5NLE2-450E		LCU 450E	450E	15				



EPN.com.cn 电子产品世界

# E Rated Medium Voltage Fuses

Current Limiting

	Catalog Number	Old Catalog Number	Size	Dim. A (inches)	Dim. B (inches)	Max Interrupting Rating RMS (Asym)	Diagram			
8.25 Max. KV	10E-1C-8.25		10E	12"	15-7/8"	80,000	14			
	15E-1C-8.25		15E				14			
	20E-1C-8.25		20E				14			
	25E-1C-8.25		25E				14			
	30E-1C-8.25	LDZ 30E	30E				14			
	40E-1C-8.25	LDZ 40E	40E				14			
	50E-1C-8.25	LDZ 50E	50E				14			
	65E-1C-8.25	LDZ 65E	65E				14			
	80E-1C-8.25	LDZ 80E	80E				14			
	100E-1C-8.25	LDZ 100E	100E				14			
	125E-1C-8.25	LDZ 125E	125E				14			
	150E-1C-8.25	LDZ 150E	150E				14			
	125E-2C-8.25	LDZ 125E	125E				12"	15-7/8"	80,000	15
	150E-2C-8.25	LDZ 150E	150E							15
	200E-2C-8.25	LDZ 200E	200E							15
	250E-2C-8.25	LDZ 250E	250E							15
	300E-2C-8.25	LDZ 300E	300E				12"	15-7/8"	80,000	16
	350E-3C-8.25	LDZ 350Z	350E							16
400E-3C-8.25		400E								

8.25 Max. KV	8NLE-10E		10E	14"	17-7/8"	80,000	14			
	8NLE-15E		15E				14			
	8NLE-20E		20E				14			
	8NLE-25E		25E				14			
	8NLE-30E	LCZ 30E	30E				14			
	8NLE-40E	LCZ 40E	40E				14			
	8NLE-50E	LCZ 50E	50E				14			
	8NLE-65E	LCZ 65E	65E				14			
	8NLE-80E	LCZ 80E	80E				14			
	8NLE-100E	LCZ 100E	100E				14			
	8NLE2-100E	LCZ 100E	100E				14"	17-7/8"	80,000	15
	8NLE2-125E	LCZ 125E	125E							15
	8NLE2-150E	LCZ 150E	150E							15
	8NLE2-200E	LCZ 200E	200E							15
	8NLE2-250E		250E							15
										15

	Catalog Number	Old Catalog Number	Size	Dim. A (inches)	Dim. B (inches)	Max Interrupting Rating RMS (Asym)	Figure Number			
15.5 Max. KV	10E-1C-15.5	LDN 10E	10E	15"	18.875"	60,000	14			
	15E-1C-15.5	LDN 15E	15E				14			
	20E-1C-15.5	LDN 20E	20E				14			
	25E-1C-15.5	LDN 25E	25E				14			
	30E-1C-15.5	LDN 30E	30E				14			
	40E-1C-15.5	LDN 40E	40E				14			
	50E-1C-15.5	LDN 50E	50E				14			
	65E-1C-15.5	LDN 65E	65E				14			
	80E-1C-15.5	LDN 80E	80E				14			
	100E-1C-15.5	LDN 100E	100E				14			
	65E-2C-15.5		65E				15"	18.875"	60,000	15
	80E-2C-15.5		80E							15
	100E-2C-15.5		100E							15
	125E-2C-15.5		125E							15
	150E-2C-15.5	LDN 150E	150E							15
	175E-2C-15.5	LDN 175E	175E							15
	200E-2C-15.5		200E				15"	18.875"	60,000	16
	200E-3C-15.5		200E							16
	250E-3C-15.5		250E							16
	300E-3C-15.5		300E							16



# E Rated Medium Voltage Fuses

Current Limiting

 RATED	Catalog Number	Old Catalog Number	Size	Dim. A (inches)	Dim. B (inches)	Max Interrupting Rating RMS (Asym)	Figure Number
15.5 Max. KV	15GSE-65E	—	65E	18"	21-7/8"	60,000	14
	15GSE-80E		80E				14
	15GSE-100E		100E				14
	15GSE2-125E	—	125E	18"	21-7/8"	60,000	15
	15GSE2-150E		150E				15
	15GSE2-175E		175E				15
15GSE2-200E	200E		15				

15.5 Max. KV	15NLE-10E	LCN 30E LCN 40E LCN 50E LCN 65E LCN 80ES LCN 100ES	10E	20"	23-7/8"	60,000	14
	15NLE-15E		15E				14
	15NLE-20E		20E				14
	15NLE-25E		25E				14
	15NLE-30E		30E				14
	15NLE-40E		40E				14
	15NLE-50E		50E				14
	15NLE-65E		65E				14
	15NLE-80E		80E				14
	15NLE-100E		100E				14
	15NLE2-80E	LCN 80E LCN 100E LCN 125X LCN 150E LCN 200ED	80E	20"	23-7/8"	60,000	15
	15NLE2-100E		100E				15
	15NLE2-125E		125E				15
	15NLE2-150E		150E				15
	15NLE2-175E		175E				15
	15NLE2-200E		200E				15
	15NLE3-150E	—	150E	20"	23-7/8"	60,000	16
	15NLE3-175E		175E				16
15NLE3-250E	250E		16				
15NLE3-300E	300E		16				



 RATED	Catalog Number	Old Catalog Number	Size	Dim. A (inches)	Dim. B (inches)	Max Interrupting Rating RMS (Asym)	Figure Number
25.8 Max. KV	15E-1C-25.8	—	15E	21"	24-5/8"	40,000	14
	20E-1C-25.8		20E				14
	25E-1C-25.8		25E				14
	30E-1C-25.8		30E				14
	40E-1C-25.8		40E				14
	50E-1C-25.8		50E				14
	65E-2C-25.8	—	65E	21"	24-5/8"	40,000	15
	80E-2C-25.8		80E				15
	100E-2C-25.8		100E				15

 RATED	Catalog Number	Old Catalog Number	Size	Dim. A (inches)	Dim. B (inches)	Max Interrupting Rating RMS (Asym)	Figure Number
38 Max. KV	3E-1C-38.0	—	3E	27"	30-5/8"	20,000	14
	7E-1C-38.0		7E				14
	10E-1C-38.0		10E				14
	15E-1C-38.0		15E				14
	20E-1C-38.0		20E				14
	25E-1C-38.0		25E				14
	30E-1C-38.0		30E				14
	40E-1C-38.0		40E				14
	50E-2C-38.0	—	50E	27"	30-5/8"	20,000	15
	65E-2C-38.0		65E				15
	80E-2C-38.0		80E				15

# E Rated Medium Voltage Fuses

Current Limiting

## Clip Lock Design

The clip lock type designs ensures a positive contact between the fuse and the connection cam. The fuse's clip lock tab slides in between the clip casting and the cam to prevent the fuse from slipping or blowing out of the holder. This positive contact improves heat dissipation and allows fuses to run cooler.

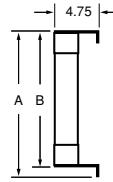

FIGURE 17

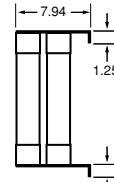

FIGURE 18<sup>25</sup>

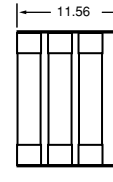
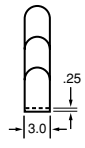

FIGURE 19



<b>RATED</b>	Catalog Number	Old Catalog Number	Size	Dim. A (inches)	Dim. B (inches)	Max Interrupting Rating RMS (Asym)	Figure Number
<b>5.5 Max. KV</b> Clip Lock	10E-1CL-5.5		10E	16.38"	15.13"	80,000	17
	15E-1CL-5.5		15E				17
	20E-1C-5.5		20E				17
	25E-1CL-5.5		25E				17
	30E-1CL-5.5		30E				17
	40E-1CL-5.5		40E				17
	50E-1CL-5.5	—	50E				17
	65E-1CL-5.5		65E				17
	80E-1CL-5.5		80E				17
	100E-1CL-5.5		100E				17
	125E-1CL-5.5		125E	17			
	150E-1CL-5.5		150E	17			
	225E-2CL-5.5		225E	17.38"	16.13"	80,000	18
	250E-2CL-5.5		250E				18
	300E-2CL-5.5	—	300E				18
	350E-2CL-5.5		350E				18
	400E-2CL-5.5		400E				18
	450E-2CL-5.5		450E	18			
500E-3CL-5.5		500E	17.38"	16.13"	80,000	19	
550E-3CL-5.5	—	550E				19	
600E-3CL-5.5		600E				19	

<b>RATED</b>	Catalog Number	Old Catalog Number	Size	Dim. A (inches)	Dim. B (inches)	Max Interrupting Rating RMS (Asym)	Figure Number
<b>8.25 Max. KV</b> Clip Lock	10E-1CL-8.25		10E	17.38"	16.13"	80,000	17
	15E-1CL-8.25		15E				17
	20E-1C-8.25		20E				17
	25E-1CL-8.25		25E				17
	30E-1CL-8.25		30E				17
	40E-1CL-8.25		40E				17
	50E-1CL-8.25	—	50E				17
	65E-1CL-8.25		65E				17
	80E-1CL-8.25		80E				17
	100E-1CL-8.25		100E				17
	125E-2CL-8.25		125E	17.38"	16.13"	80,000	18
	150E-2CL-8.25		150E				18
	175E-2CL-8.25		175E				18
	200E-2CL-8.25	—	200E				18
	225E-2CL-8.25		225E				18
	250E-2CL-8.25		250E	18			
	300E-2CL-8.25		300E	18			
	350E-3CL-8.25		350E	17.38"	16.13"	80,000	19

<b>RATED</b>	Catalog Number	Old Catalog Number	Size	Dim. A (inches)	Dim. B (inches)	Max Interrupting Rating RMS (Asym)	Figure Number
<b>15.5 Max. KV</b> Clip Lock	10E-1CL-15.5		10E	19.8"	18.1"	60,000	17
	15E-1CL-15.5		15E				17
	20E-1CL-15.5		20E				17
	25E-1CL-15.5	—	25E				17
	30E-1CL-15.5		30E				17
	40E-1CL-15.5		40E	17			
	50E-1CL-15.5		50E	17			
	65E-1CL-15.5		65E	22.81"	21.13"	60,000	17
	80E-1CL-15.5	—	80E				17
	100E-1CL-15.5		100E				17
	125E-2CL-15.5		125	22.81"	19.1"	60,000	18
	150E-3CL-15.5		150E	22.81"	19.1"	60,000	19
	175E-3CL-15.5		175E				19
	200E-3CL-15.5	—	200E				19
	225E-3CL-15.5		225E				19
250E-3CL-15.5		250E	19				
300E-3CL-15.5		300E	19				

