

# FAN2558/FAN2559

## 180mA Low Voltage CMOS LDO

### Features

- Fixed 1.0V, 1.2V, 1.3V, 1.5V, 1.8V, 2.5V, 3.3V, 3.5V, 3.6V, 3.8V and Adjustable Output
- Power Good Indicator with Open Drain Output
- 180mA Output Current
- 100 $\mu$ A Ground Current
- $C_{bypass}$  for Low Noise Operation
- Fast Enable for CDMA Applications
- High Ripple Rejection
- Current Limit
- Thermal Shutdown
- Excellent Line and Load Regulation
- Requires Only 1 $\mu$ F Output Capacitor
- Stable with 0 to 300m $\Omega$  ESR
- TTL-level Compatible Enable Input
- Active Output Discharge

### Applications

- Processor Power-up sequencing
- PDAs, Cell Phones
- Portable Electronic Equipment
- PCMCIA Vcc and Vpp regulation/switching

### General Description

The FAN2558/9 low voltage CMOS LDOs feature fixed or adjustable output voltage, 180mA load current, delayed power good output (open drain) and 1% output accuracy with excellent line and load regulation. An external bypass capacitor provides ultra-low noise operation.

The FAN2558/9 low voltage LDOs incorporate both thermal shutdown and short circuit protection. Output is stable with a 1 $\mu$ F, low ESR capacitor. The FAN2558/9 family is available in 5-Lead SOT-23, 6-Lead SOT-23 and 2x2mm MLP-6 packages.

**FAN2558:** Fixed Output LDO with Power Good output

**FAN2558ADJ:** Adjustable Output LDO with Power Good output

**FAN2559:** Fixed Output LDO with Power Good output, Low Noise

Available standard output voltages are 1.0, 1.2V, 1.3V, 1.5V, 1.8V, 2.5V, 3.3V, 3.5V, 3.6V, and 3.8V. Custom output voltage options are also available.

### Typical Application

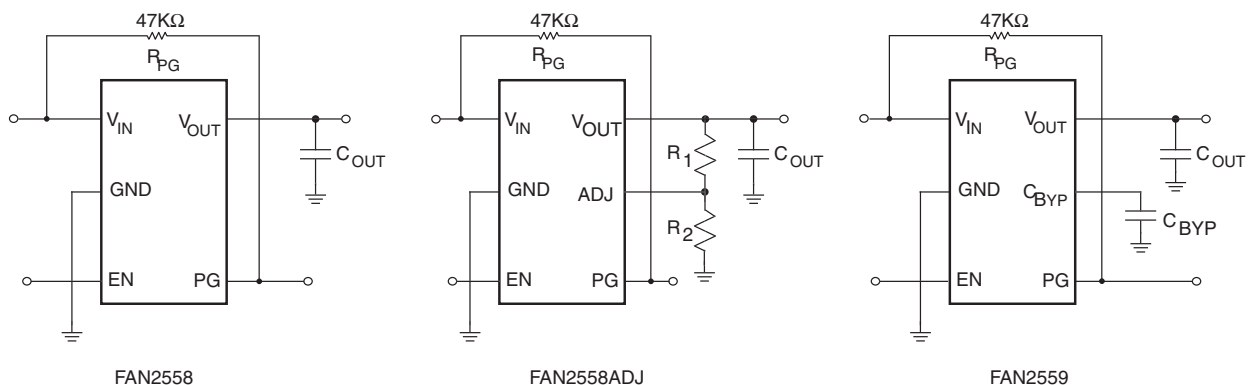

## Pin Assignments

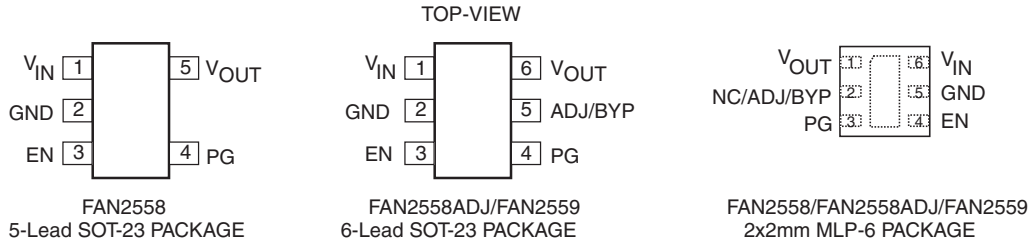

Pin no.	Pin Name					
	FAN2558		FAN2558ADJ		FAN2559	
	5SOT-23	2x2mm MLP-6	6SOT-23	2x2mm MLP-6	6SOT-23	2x2mm MLP-6
1	V <sub>IN</sub>	V <sub>OUT</sub>	V <sub>IN</sub>	V <sub>OUT</sub>	V <sub>IN</sub>	V <sub>OUT</sub>
2	GND.	NC	GND.	ADJ	GND.	BYP
3	EN	PG	EN	PG	EN	PG
4	PG	EN	PG	EN	PG	EN
5	V <sub>OUT</sub>	GND	ADJ	GND	BYP	GND
6		V <sub>IN</sub>	V <sub>OUT</sub>	V <sub>IN</sub>	V <sub>OUT</sub>	V <sub>IN</sub>

## Pin Descriptions

Symbol	Pin Function Description
V <sub>IN</sub>	Power Supply Input
V <sub>OUT</sub>	Regulated Voltage Output
GND	Ground Connection
PG	Power Good Output, Open Drain
ADJ	Ratio of potential divider from V <sub>out</sub> to ADJ determines output voltage
BYP	Reference Noise Bypass
EN	Chip Enable Input. The regulator is fully enabled when TTL "H" is applied to this input. The regulator enters into shutdown mode when TTL "L" is applied to this input.

## Absolute Maximum Ratings

Parameter		Min.	Max.	Units
$V_{IN}$ to GND			6	V
Voltage on any other pin to GND		-0.3	$V_{IN} + 0.3$	V
Junction Temperature ( $T_J$ )		-55	150	°C
Storage Temperature		-65	150	°C
Lead Soldering Temperature, 10 seconds			300	°C
Power Dissipation ( $P_D$ )			Internally Limited	W
Electrostatic Discharge (ESD) Protection (Note1)	HBM	4		kV
	CDM	1		

## Recommended Operating Conditions

Parameter		Min.	Typ.	Max.	Units
Supply Voltage Range, $V_{IN}$ for $V_{OUT} < 2.0V$		2.7		5.5	V
Supply Voltage Range, $V_{IN}$ for $V_{OUT} \geq 2.0V$	$V_{OUT} + V_{DROPOUT}$			5.5	V
Load Current				180	mA
Enable Input Voltage $V_{EN}$		0		$V_{IN}$	V
Power Good Output Voltage Range $V_{PG}$		0		$V_{IN}$	V
Junction Temperature		-40		125	°C
Thermal Resistance-Junction to Ambient SOT-23 (Note 2)				235	°C/W
Thermal Resistance-Junction to Case, 2mm x 2mm 6-lead MLP				75	

### Notes:

- Using Mil Std. 883E, method 3015.7 (Human Body Model) and EIA/JESD22C101-A (Charge Device Model)
- Junction to ambient thermal resistance,  $\Theta_{JC}$ , is a strong function of PCB material, board thickness, thickness and number of copper plains, number of via used, diameter of via used, available copper surface, and attached heat sink characteristics.

## Electrical Characteristics

$V_{IN} = V_{IN \text{ min}}$  (note 5) to 5.5V,  $V_{EN} = V_{IN}$ ,  $I_{LOAD} = 100\mu\text{A}$ ,  $T_A = -40^\circ\text{C}$  to  $+85^\circ\text{C}$ , unless otherwise noted. Typical values are at  $25^\circ\text{C}$ .

Symbol	Parameter	Conditions	Min.	Typ.	Max.	Units
$V_{OUT}$	Output Voltage Accuracy (Note 3)	$I_{LOAD} = 100\mu\text{A}$	-2	1	2	%
$V_{OUT(ADJ)}$	Output Voltage Range (Adjustable)	$I_{LOAD} = 100\mu\text{A}$	1		$V_{IN}$	V
$\Delta V_{OUT\_LNR}$	Line Regulation	$V_{IN \text{ min}} < V_{IN} < 5.5\text{V}$	-0.3		0.3	%/V
$\Delta V_{OUT\_LDR}$	Load Regulation (Note 4)	$I_{LOAD} = 0.1\text{mA}$ to $150\text{mA}$		2.5	4	%
$I_{SD}$	Supply Current in Shutdown Mode	$V_{EN} < 0.4\text{V}$ PG = No Connection		0.1		$\mu\text{A}$
$I_{GND}$	Ground Pin Current (Note 4)	$I_{LOAD} = 0\text{mA}$ , $V_{IN} = 5.5\text{V}$		90	150	$\mu\text{A}$
		$I_{LOAD} = 150\text{mA}$ , $V_{IN} = 5.5\text{V}$		110	150	
$I_{LIM}$	Current Limit	$V_{OUT} = 0\text{V}$	260	350	500	mA
$T_{SD}$	Thermal Shutdown Temperature			150		$^\circ\text{C}$
	Thermal Shutdown Hysteresis			10		$^\circ\text{C}$
$V_{ENL}$	Enable Input Low	$V_{IN} = 5.5\text{V}$ , Shutdown			0.4	V
$V_{ENH}$	Enable Input High	$V_{IN} = 5.5\text{V}$ , Enabled	1.6			V
$I_E$	Enable Input Current	$V_{ENL} \leq 0.4\text{V}$ , $V_{IN} = 5.5\text{V}$		0.01		$\mu\text{A}$
		$V_{ENH} \geq 1.6\text{V}$ , $V_{IN} = 5.5\text{V}$		0.01		
$V_{PG}$	Low Threshold	% of $V_{OUT}$ PG ON	89			%
	High Threshold	% of $V_{OUT}$ PG OFF			97	%
$V_{PGL}$	PG Output Low Voltage	$I_{PG\_SINK} = 100\mu\text{A}$ , Fault Condition		0.02	0.1	V
$I_{PG}$	PG Leakage Current	PG off, $V_{PG} = 5.5\text{V}$		0.01		$\mu\text{A}$
$T_{EN}$	Enable Response Time	$C_{OUT} = 1\mu\text{F}$ $C_{BYPASS} = 10\text{nF}$		30	300	$\mu\text{S}$
$T_{ON}$	Power "ON" Delay Time	$C_{OUT} = 1\mu\text{F}$ $C_{BYPASS} = 10\text{nF}$ $V_{ENL} \geq 1.6\text{V}$ , $V_{IN} = 0\text{V}$ to $V_{OUT} + 1\text{V}$		300	500	$\mu\text{S}$
$D_{PG}$	PG Delay time		1		5	mS
$V_{DROD-OUT}$	Dropout Voltage (For Adjustable Output Version)	$V_{OUT} > 2.7\text{V}$ and $I_{LOAD} = 180\text{mA}$		400		mV
$V_{FB\_ADJ}$	Feedback Voltage (For Adjustable Output Version)			0.59		V

### Note:

3. Guaranteed  $\pm 1\%$  output voltage accuracy parts are available on customer request.
4. Measured at constant junction temperature using low duty cycle pulse testing.
5.  $V_{IN \text{ min}} = 2.7\text{V}$  or  $(V_{OUT} + 1\text{V})$ , whichever is greater.

**DC Electrical Characteristics** (Continued)

$V_{IN} = V_{IN \text{ min}}$  (note 5) to 5.5V,  $V_{EN} = V_{IN}$ ,  $I_{LOAD} = 100\mu\text{A}$ ,  $T_A = -40^\circ\text{C}$  to  $+85^\circ\text{C}$ , unless otherwise noted. Typical values are at  $25^\circ\text{C}$ .

Symbol	Parameter	Conditions	Min.	Typ.	Max.	Units
PSRR	Power Supply Rejection Ratio	DC to 100kHz $C_{OUT} = 1\mu\text{F}$ $C_{BYPASS} = 10\text{nF}$ $I_{LOAD} = 0$ to 150mA $V_{OUT} \leq 1.8\text{V}$		50		dB
$e_N$	Output Noise	BW: 300Hz to 50kHz $C_{OUT} = 1\mu\text{F}$ $C_{BYPASS} = 10\text{nF}$ $I_{LOAD} = 0$ to 150mA		30		$\mu\text{V}_{RMS}$

EEPW 电子产品世界 .com.cn

## Functional Description

Utilizing BiCMOS technology, the FAN2525/FAN2559 product family is optimized for use in compact battery powered systems. These LDOs offer a unique combination of high ripple rejection, low noise, low power consumption, high tolerance for a variety of output capacitors, and less than  $1\mu\text{A}$  “OFF” current. In the circuit, a differential current sense amplifier controls a series-pass P-Channel MOSFET to achieve high ripple rejection. A separate error amplifier compares the load voltage at the output with an onboard trimmed low voltage bandgap reference for output regulation.

Thermal shutdown and current limit circuits protect the device under extreme conditions. When the device temperature reaches  $150^{\circ}\text{C}$ , the output is disabled. When the device cools down by  $10^{\circ}\text{C}$ , it is re-enabled. The user can shut down the device using the Enable control pin at any time. The current limit circuit is trimmed, which leads to consistent power on /enable delays, and provides safe short circuit current densities even in narrow traces of the PCB.

A carefully optimized control loop accommodates a wide range of ESR values in the output bypass capacitor, allowing the user to optimize space, cost, and performance requirements.

An Enable pin shuts down the regulator output to conserve power, reducing supply current to less than  $1\mu\text{A}$ .

The fixed-voltage FAN2559 has a noise bypass pin. Power Good is available as a diagnostic function to indicate that the output voltage has reduced within 5% of the nominal value.

The six pin adjustable-voltage version utilizes pin 5 to connect to an external voltage divider which feeds back to the regulator error amplifier, thus setting the output voltage to the desired value.

## Applications Information

### External Capacitors – Selection

The FAN2558/FAN2559 gives the user the flexibility to utilize a wide variety of capacitors compared to other LDOs. An innovative design approach offers significantly reduced sensitivity to ESR, which degrades regulator loop stability in older designs. While the improvements featured in the FAN2558/FAN2559 family greatly simplify the design task,

capacitor quality still must be considered if the designer is to achieve optimal circuit performance. In general, ceramic capacitors offer superior ESR performance, and a smaller case size than tantalum capacitors.

### Input Capacitor

An input capacitor of  $2.2\mu\text{F}$  (nominal value) or greater, connected between the Input pin and Ground, placed in close proximity to the device, will improve transient response and ripple rejection. Higher values will further improve ripple rejection and transient response. An input capacitor is recommended when the input source, either a battery or a regulated AC voltage, is located far from the device. Any good quality ceramic, tantalum, or metal film capacitor will give acceptable performance; however, in extreme cases capacitor surge current ratings may have to be considered.

### Output Capacitor

An output capacitor is required to maintain regulator loop stability. Stable operation will be achieved with a wide variety of capacitors with ESR values ranging from  $0\text{m}\Omega$  up to  $400\text{m}\Omega$ . Multilayer ceramic, tantalum or aluminum electrolytic capacitors may be used. A nominal value of at least  $1\mu\text{F}$  is recommended. Note that the choice of output capacitor affects load transient response, ripple rejection, and it has a slight effect on noise performance as well.

An internal resistor of approximately  $100\Omega$  is connected between  $V_{\text{OUT}}$  and GND in shutdown mode, to discharge the output capacitor at a faster rate.

### Bypass Capacitor (FAN2559 Only)

In the fixed-voltage configuration, connecting a capacitor between the bypass pin and ground can significantly reduce output noise. Values ranging from  $0\text{pF}$  to  $47\text{nF}$  can be used, depending on the sensitivity to output noise in the application.

At the high-impedance Bypass pin, care must be taken in the PCB layout to minimize noise pickup, and capacitors must be selected to minimize current loading (leakage). Noise pickup from external sources can be considerable. Leakage currents into the Bypass pin will directly affect regulator accuracy and should be kept as low as possible; thus, high-quality ceramic and film types are recommended for their low leakage characteristics. Cost-sensitive applications not concerned with noise can omit this capacitor.

## Control Functions

### Enable Pin

Connecting 2V or greater to the Enable pin will enable the output, while 0.4V or less will disable it while reducing the quiescent current consumption to less than 1 $\mu$ A. If this shut-down function is not needed, the pin can simply be connected permanently to the V<sub>IN</sub> pin. Allowing this pin to float will cause erratic operation.

### Error Flag (Power Good)

Fault conditions such as input voltage dropout (low V<sub>IN</sub>), overheating, or overloading (excessive output current), will set an error flag. The PG pin which is an open-drain output, will go LOW when V<sub>OUT</sub> is less than 95% or the specified output voltage. When the voltage at V<sub>OUT</sub> is greater than 95% of the specified output voltage, the PG pin is HIGH. A logic pull-up resistor of 47K $\Omega$  is recommended at this output. The pin can be left disconnected if unused.

### Thermal Protection

The FAN2558/FAN2559 is designed to supply high peak output currents for brief periods, however sustained excessive output load at high input - output voltage difference will increase the device's temperature and exceed maximum ratings due to power dissipation. During output overload conditions, when the die temperature exceeds the shutdown limit temperature of 150°C, an onboard thermal protection will disable the output until the temperature drops approximately 10°C below the limit, at which point the output is re-enabled. During a thermal shutdown, the user may assert the power-down function at the Enable pin, reducing power consumption to a minimum.

### Thermal Characteristics

The FAN2558/FAN2559 is designed to supply 180mA at the specified output voltage with an operating die (junction) temperature of up to 125°C. Once the power dissipation and thermal resistance is known, the maximum junction temperature of the device can be calculated. While the power dissipation is calculated from known electrical parameters, the actual thermal resistance depends on the thermal characteristics of the SOT23-5 surface-mount package and the surrounding PC board copper to which it is mounted.

The power dissipation is equal to the product of the input-to-output voltage differential and the output current plus the ground current multiplied by the input voltage, or:

$$P_D = (V_{IN} - V_{OUT}) \times I_{OUT} + V_{IN} \times I_{GND}$$

The ground pin current I<sub>GND</sub> can be found in the charts provided in the Electrical Characteristics section.

The relationship describing the thermal behavior of the package is:

$$P_{D(max)} = \left\{ \frac{T_{J(max)} - T_A}{\theta_{JA}} \right\}$$

where T<sub>J(max)</sub> is the maximum allowable junction temperature of the die, which is 125°C, and T<sub>A</sub> is the ambient operating temperature.  $\theta_{JA}$  is dependent on the surrounding PC board layout and can be empirically obtained. While the  $\theta_{JC}$  (junction-to-case) of the SOT23-5 package is specified at 130°C/W, the  $\theta_{JA}$  of the minimum PWB footprint will be at least 235°C/W. This can be improved by providing a heat sink of surrounding copper ground on the PWB. Depending on the size of the copper area, the resulting  $\theta_{JA}$  can range from approximately 180°C/W for one square inch to nearly 130°C/W for 4 square inches. The addition of backside copper with through-holes, stiffeners, and other enhancements can also aid in reducing thermal resistance. The heat contributed by the dissipation of other devices located nearby must be included in the design considerations. Once the limiting parameters in these two relationships have been determined, the design can be modified to ensure that the device remains within specified operating conditions. If overload conditions are not considered, it is possible for the device to enter a thermal cycling loop, in which the circuit enters a shutdown condition, cools, re-enables, and then again overheats and shuts down repeatedly due to an unmanaged fault condition.

### Adjustable Version

The FAN2558ADJ includes an input pin ADJ which allows the user to select an output voltage ranging from 1V to near V<sub>IN</sub>, using an external resistor divider. The voltage V<sub>ADJ</sub> presented to the ADJ pin is fed to the onboard error amplifier which adjusts the output voltage until V<sub>ADJ</sub> is equal to the onboard bandgap reference voltage of 1.00V(typ). The equation is:

$$V_{OUT} = 0.59V \times \left[ 1 + \frac{R_1}{R_2} \right]$$

Since the bandgap reference voltage is trimmed, 1% initial accuracy can be achieved. The total value of the resistor chain should not exceed 250K $\Omega$  total to keep the error amplifier biased during no-load conditions. Programming output voltages very near V<sub>IN</sub> need to allow for the magnitude and variation of the dropout voltage V<sub>DO</sub> over load, supply, and temperature variations. Note that the low-leakage FET input to the CMOS error amplifier induces no bias current error to the calculation.

### General PCB Layout Considerations

For optimum device performance, careful circuit layout and grounding techniques must be used. Establishing a small local ground, to which the GND pin, and the output and bypass capacitors are connected, is recommended. The input capacitor should be grounded to the main ground plane. The quiet local ground is then routed back to the main ground plane using feed through via. In general, the high-frequency compensation components (input, bypass, and output capacitors) should be located as close to the device as possible. Close proximity of the output capacitor is especially important to achieve optimum performance, especially during high

load conditions. A large copper area in the local ground serves as heat sink (as discussed above) when high power dissipation significantly increases device temperature. Component-side copper provides significantly better thermal performance. Added feed through connecting the device side ground plane to the back plane further reduces thermal resistance.

EEPW 电子产品世界  
.com.cn



**Block Diagram** (Note 6)

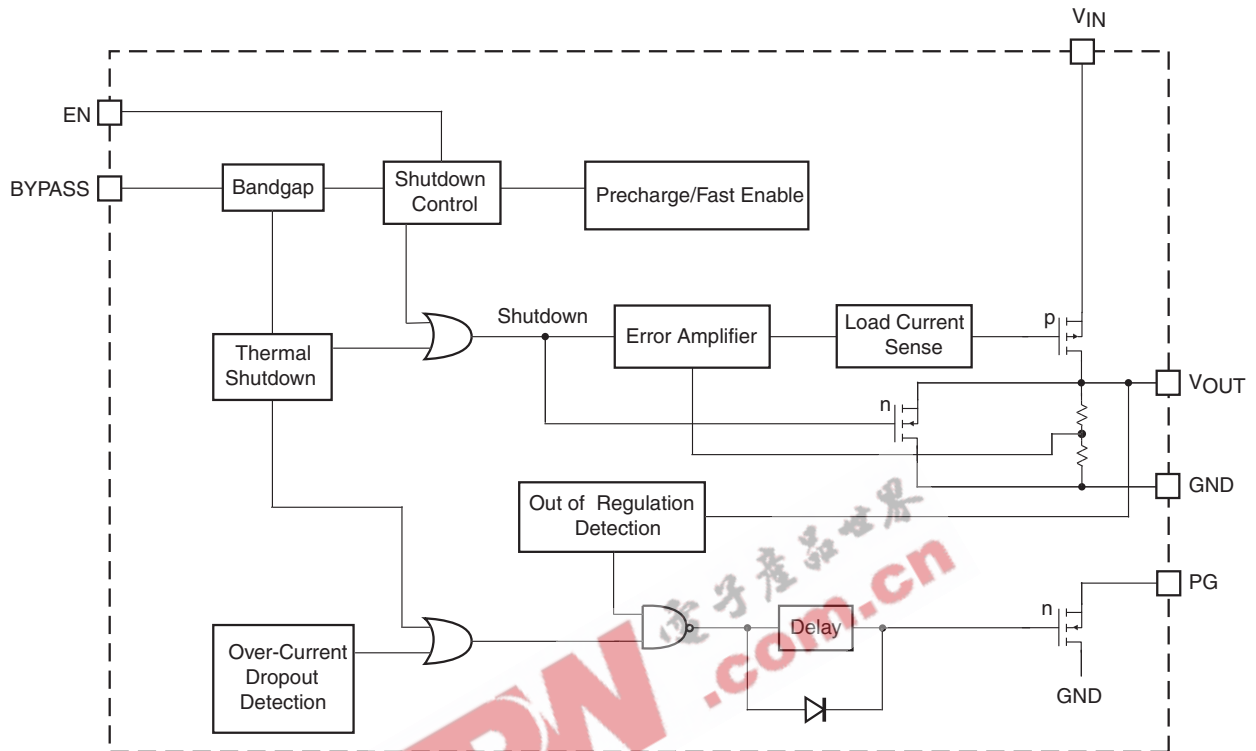

**Note:**

6. Fixed output voltage version. BYPASS pin is available for FAN2559 only.

### Typical Performance Characteristics

Unless otherwise specified,  $C_{IN} = C_{OUT} = 1\mu F$ ,  $R_{PG} = 47k\Omega$ ,  $T_A = 25^\circ C$ ,  $EN = V_{IN}$

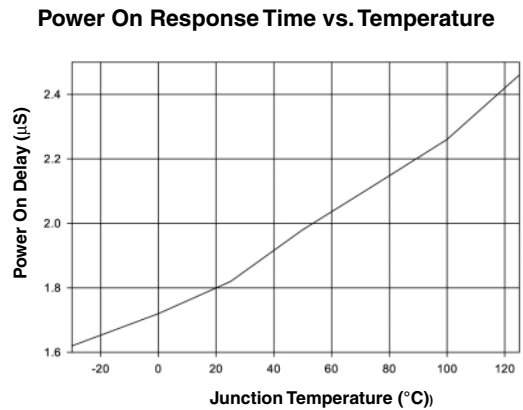
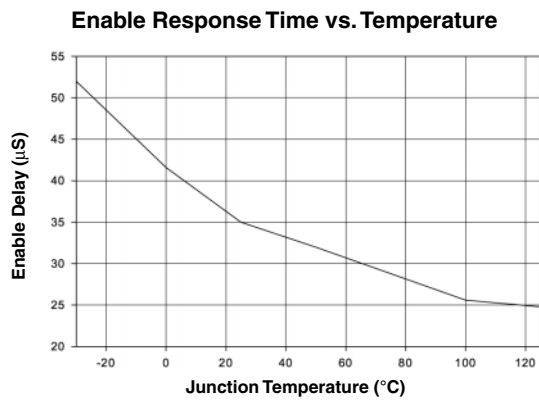
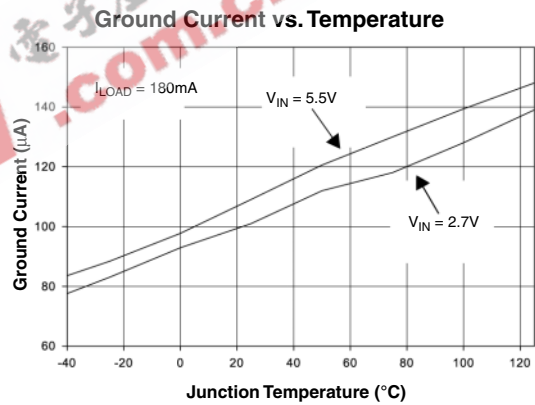
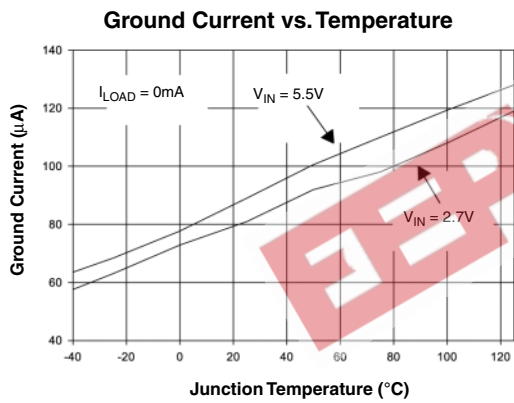
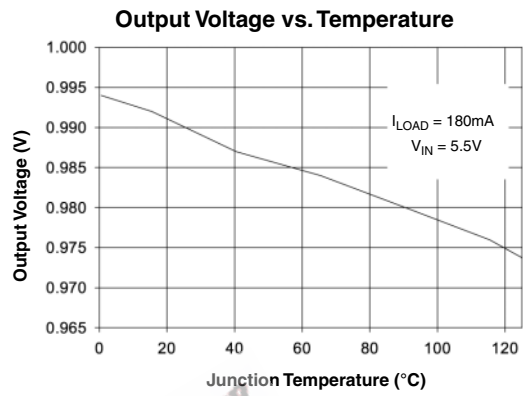
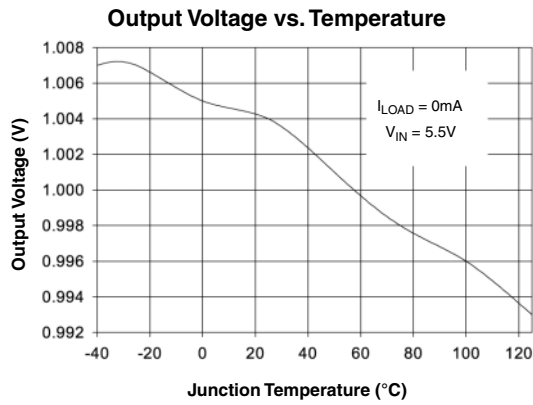

### Typical Performance Characteristics (Continued)

Unless otherwise specified,  $C_{IN} = C_{OUT} = 1\mu F$ ,  $R_{PG} = 47k\Omega$ ,  $T_A = 25^\circ C$ ,  $EN = V_{IN}$

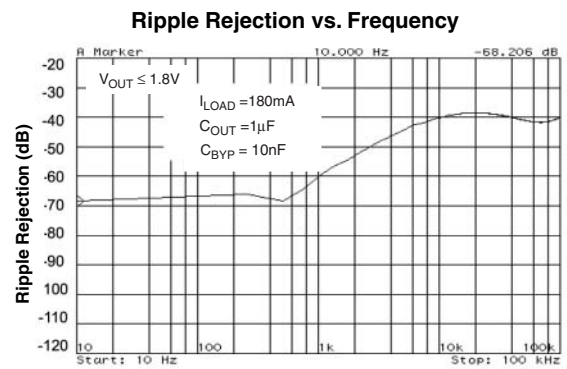
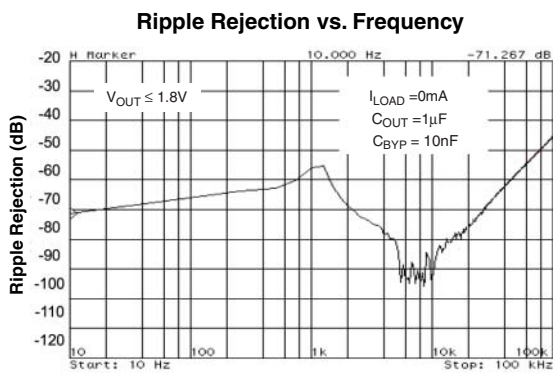
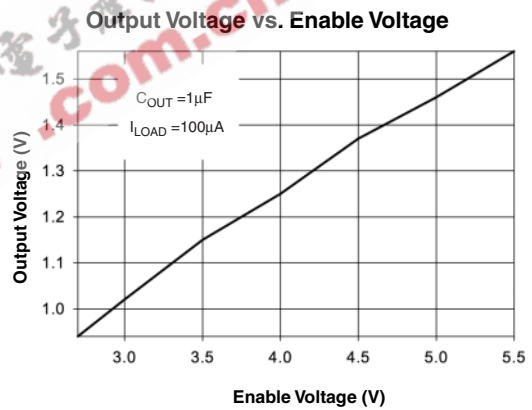
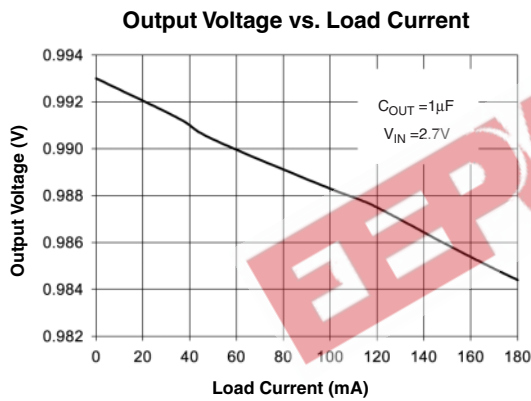
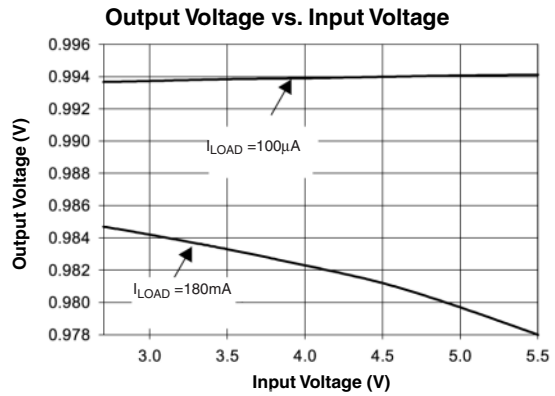
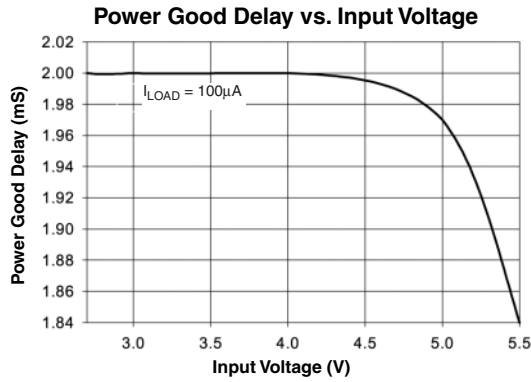

### Typical Performance Characteristics (Continued)

Unless otherwise specified,  $C_{IN} = C_{OUT} = 1\mu F$ ,  $R_{PG} = 47k\Omega$ ,  $T_A = 25^\circ C$ ,  $EN = V_{IN}$

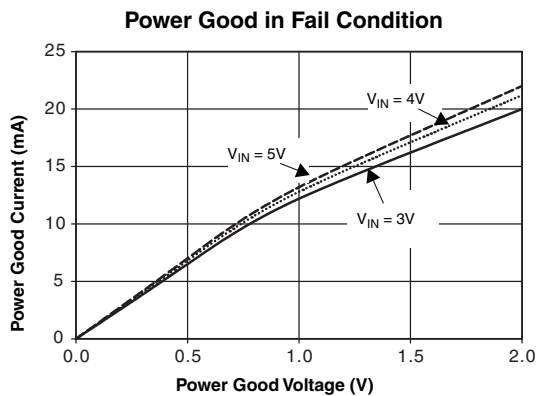
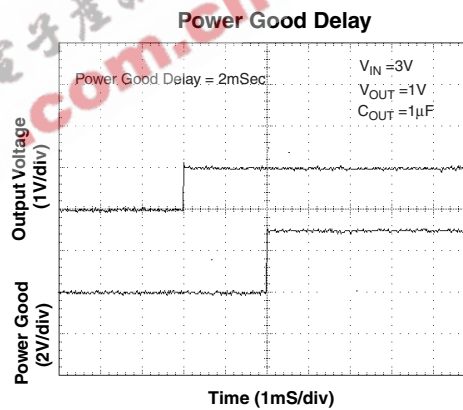
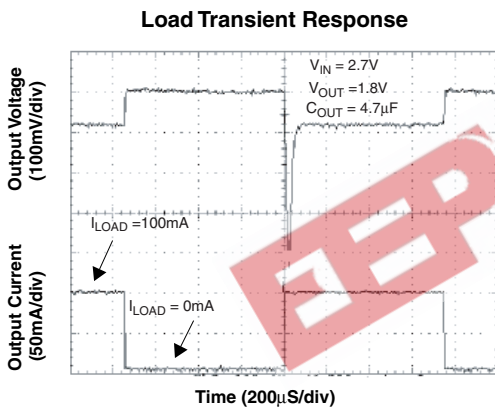
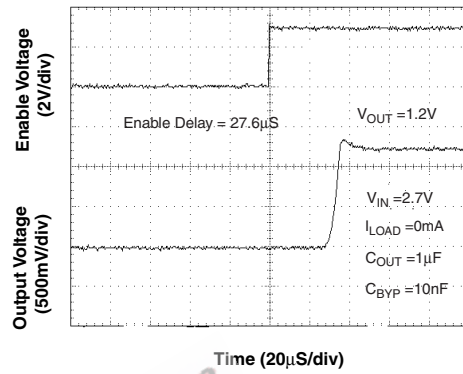
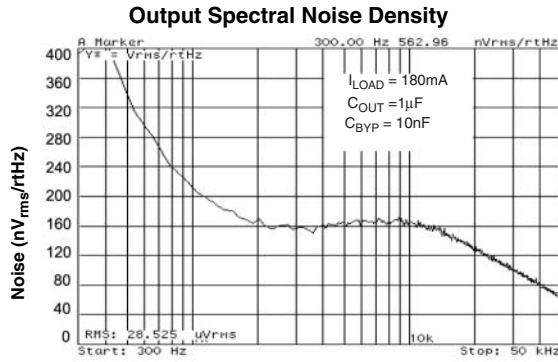



### Mechanical Dimensions

#### 6-Lead SOT-23 Package

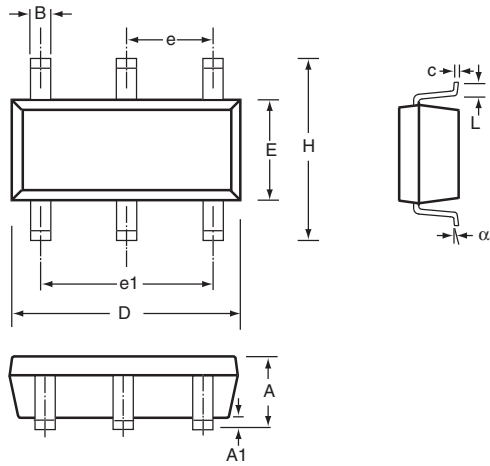

#### 5-Lead SOT-23 Package

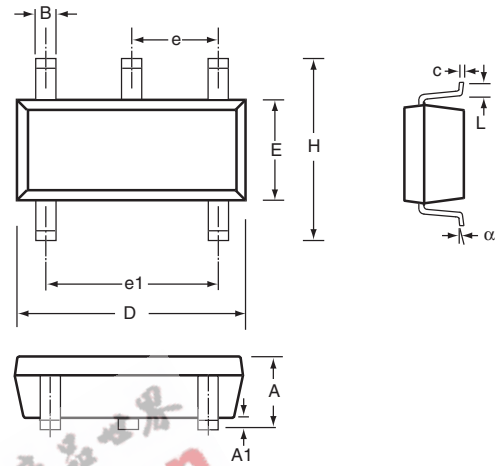

Symbol	Inches		Millimeters		Notes
	Min	Max	Min	Max	
A	.035	.057	.90	1.45	
A1	.000	.006	.00	.15	
B	.008	.020	.20	.50	
c	.003	.010	.08	.25	
D	.106	.122	2.70	3.10	
E	.059	.071	1.50	1.80	
e	.037 BSC		.95 BSC		
e1	.075 BSC		1.90 BSC		
H	.087	.126	2.20	3.20	
L	.004	.024	.10	.60	
α	0°	10°	0°	10°	

**Notes:**

- 7. Package outline exclusive of mold flash & metal burr.
- 8. Package outline exclusive of solder plating.
- 9. EIAJ Ref Number SC\_74A

## Ordering Information

T<sub>A</sub> = -40°C to 85°C

Part Number	Output Voltage	Package Marking	Package	Order Code	
FAN2558	1.0V	58T	5-Lead SOT-23	FAN2558S10X	
	1.2V	58U		FAN2558S12X	
	1.3V	58X		FAN2558S13X	
	1.5V	58V		FAN2558S15X	
	1.8V	58O		FAN2558S18X	
	2.5V	58J		FAN2558S25X	
	3.3V	58K		FAN2558S33X	
	3.5V	58P		FAN2558S35X	
	3.6V	58Q		FAN2558S36X	
	3.8V	58I		FAN2558S38X	
	1.0V	58T		2mm x 2mm 6-Lead MLP	FAN2558MP10X
	1.2V	58U	FAN2558MP12X		
	1.3V	58X	FAN2558MP13X		
	1.5V	58V	FAN2558MP15X		
	1.8V	58O	FAN2558MP18X		
	Adjustable	58R	6-Lead SOT-23	FAN2558SX	
		58R	2mm x 2mm 6-Lead MLP	FAN2558MPX	
	FAN2559	1.0V	59T	6-Lead SOT-23	FAN2559S10X
		1.2V	59U		FAN2559S12X
1.3V		59X	FAN2559S13X		
1.5V		59V	FAN2559S15X		
1.8V		59O	FAN2559S18X		
1.0V		59T	2mm x 2mm 6-Lead MLP		FAN2559MP10X
1.2V		59U		FAN2559MP12X	
1.3V		59X		FAN2559MP13X	
1.5V		59V		FAN2559MP15X	
1.8V		59O		FAN2559MP18X	

### DISCLAIMER

FAIRCHILD SEMICONDUCTOR RESERVES THE RIGHT TO MAKE CHANGES WITHOUT FURTHER NOTICE TO ANY PRODUCTS HEREIN TO IMPROVE RELIABILITY, FUNCTION OR DESIGN. FAIRCHILD DOES NOT ASSUME ANY LIABILITY ARISING OUT OF THE APPLICATION OR USE OF ANY PRODUCT OR CIRCUIT DESCRIBED HEREIN; NEITHER DOES IT CONVEY ANY LICENSE UNDER ITS PATENT RIGHTS, NOR THE RIGHTS OF OTHERS.

### LIFE SUPPORT POLICY

FAIRCHILD'S PRODUCTS ARE NOT AUTHORIZED FOR USE AS CRITICAL COMPONENTS IN LIFE SUPPORT DEVICES OR SYSTEMS WITHOUT THE EXPRESS WRITTEN APPROVAL OF THE PRESIDENT OF FAIRCHILD SEMICONDUCTOR CORPORATION. As used herein:

1. Life support devices or systems are devices or systems which, (a) are intended for surgical implant into the body, or (b) support or sustain life, and (c) whose failure to perform when properly used in accordance with instructions for use provided in the labeling, can be reasonably expected to result in a significant injury of the user.
2. A critical component in any component of a life support device or system whose failure to perform can be reasonably expected to cause the failure of the life support device or system, or to affect its safety or effectiveness.