

FDMA1027P

Dual P-Channel PowerTrench® MOSFET

General Description

This device is designed specifically as a single package solution for the battery charge switch in cellular handset and other ultra-portable applications. It features two independent P-Channel MOSFETs with low on-state resistance for minimum conduction losses. When connected in the typical common source configuration, bi-directional current flow is possible.

The MicroFET 2x2 package offers exceptional thermal performance for its physical size and is well suited to linear mode applications.

Features

- -3.0 A, -20V. $R_{DS(ON)} = 120\text{ m}\Omega @ V_{GS} = -4.5\text{ V}$
 $R_{DS(ON)} = 160\text{ m}\Omega @ V_{GS} = -2.5\text{ V}$
 $R_{DS(ON)} = 240\text{ m}\Omega @ V_{GS} = -1.8\text{ V}$
- Low Profile - 0.8 mm maximum - in the new package MicroFET 2x2 mm
- RoHS Compliant

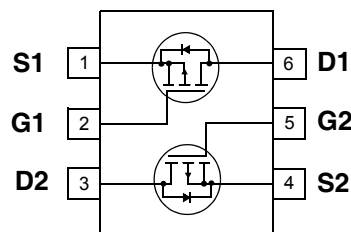
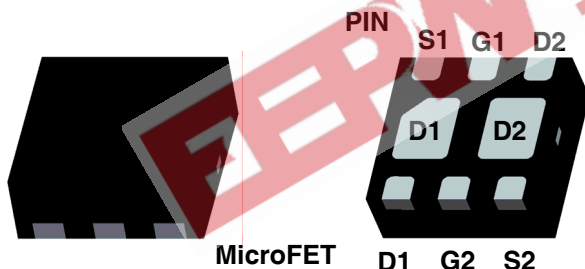

Absolute Maximum Ratings $T_A = 25^\circ\text{C}$ unless otherwise noted

Symbol	Parameter	Ratings	Units
V_{DSS}	MOSFET Drain-Source Voltage	-20	V
V_{GSS}	MOSFET Gate-Source Voltage	± 8	V
I_D	Drain Current -Continuous	(Note 1a) -2.2	A
	-Pulsed	-6	
P_D	Power dissipation for Single Operation	(Note 1a) 1.4	W
	Power dissipation for Single Operation	(Note 1b) 0.7	
T_J, T_{STG}	Operating and Storage Junction Temperature Range	-55 to +150	$^\circ\text{C}$

Thermal Characteristics

$R_{\theta JA}$	Thermal Resistance, Junction-to-Ambient	(Note 1a) 86 (Single Operation)	$^\circ\text{C/W}$
$R_{\theta JA}$	Thermal Resistance, Junction-to-Ambient	(Note 1b) 173 (Single Operation)	
$R_{\theta JA}$	Thermal Resistance, Junction-to-Ambient	69 (Dual Operation)	
$R_{\theta JA}$	Thermal Resistance, Junction-to-Ambient	151 (Dual Operation)	

Package Marking and Ordering Information

Device Marking	Device	Reel Size	Tape Width	Quantity
027	FDMA1027P	7inch	8mm	3000 units

Electrical Characteristics $T_A = 25^\circ\text{C}$ unless otherwise noted

Symbol	Parameter	Test Conditions	Min	Typ	Max	Units
--------	-----------	-----------------	-----	-----	-----	-------

Off Characteristics

BV_{DSS}	Drain-Source Breakdown Voltage	$V_{GS} = 0V, I_D = -250\mu A$	-20	-	-	V
$\frac{\Delta BV_{DSS}}{\Delta T_J}$	Breakdown Voltage Temperature Coefficient	$I_D = -250\mu A$, Referenced to 25°C	-	-12	-	mV/ $^\circ\text{C}$
I_{DSS}	Zero Gate Voltage Drain Current	$V_{DS} = -16V, V_{GS} = 0V$	-	-	-1	μA
I_{GSS}	Gate-Body Leakage,	$V_{GS} = \pm 8V, V_{DS} = 0V$	-	-	± 100	nA

On Characteristics (Note 2)

$V_{GS(th)}$	Gate Threshold Voltage	$V_{DS} = V_{GS}, I_D = -250\mu A$	-0.4	-0.7	-1.3	V
$\frac{\Delta V_{GS(th)}}{\Delta T_J}$	Gate Threshold Voltage Temperature Coefficient	$I_D = -250\mu A$, Referenced to 25°C	-	2	-	mV/ $^\circ\text{C}$
$R_{DS(on)}$	Static Drain-Source On-Resistance	$V_{GS} = -4.5V, I_D = -3.0A$	-	90	120	m Ω
		$V_{GS} = -2.5V, I_D = -2.5A$	-	120	160	
		$V_{GS} = -1.8V, I_D = -1.0A$	-	172	240	
		$V_{GS} = -4.5V, I_D = -3.0A$, $T_J = 125^\circ\text{C}$	-	118	160	
$I_{D(on)}$	On-State Drain Current	$V_{GS} = -4.5V, V_{DS} = -5V$	-20	-	-	A
g_{FS}	Forward Transconductance	$V_{DS} = -5V, I_D = -3.0A$	-	7	-	S

Dynamic Characteristics

C_{iss}	Input Capacitance	$V_{DS} = -10V, V_{GS} = 0V$, $f = 1.0\text{MHz}$	-	435	-	pF
C_{oss}	Output Capacitance		-	80	-	pF
C_{rss}	Reverse Transfer Capacitance		-	45	-	pF

Switching Characteristics (Note 2)

$t_{d(on)}$	Turn-On Delay Time	$V_{DD} = -10V, I_D = -1A$ $V_{GS} = -4.5V, R_{GEN} = 6\Omega$	-	9	18	ns
t_r	Turn-On Rise Time		-	11	19	ns
$t_{d(off)}$	Turn-Off Delay Time		-	15	27	ns
t_f	Turn-Off Fall Time		-	6	12	ns
Q_g	Total Gate Charge	$V_{DS} = -10V, I_D = -3.0A$, $V_{GS} = -4.5V$	-	4	6	nC
Q_{gs}	Gate-Source Charge		-	0.8	-	nC
Q_{gd}	Gate-Drain Charge		-	0.9	-	nC

Drain-Source Diode Characteristics and Maximum Ratings

I_S	Maximum Continuous Drain-Source Diode Forward Current	-	-	-1.1	A	
V_{SD}	Drain-Source Diode Forward Voltage	$V_{GS} = 0V, I_S = -1.1 A$ (Note 2)	-	-0.8	-1.2	V
t_{rr}	Diode Reverse Recovery Time	$I_F = -3.0A, dI_F/dt = 100A/\mu s$	-	17	-	ns
Q_{rr}	Diode Reverse Recovery Charge		-	6	-	nC

Electrical Characteristics $T_A = 25^\circ\text{C}$ unless otherwise noted

Notes:

1. $R_{\theta JA}$ is determined with the device mounted on a 1 in² oz. copper pad on a 1.5 x 1.5 in. board of FR-4 material. $R_{\theta JC}$ is guaranteed by design while $R_{\theta JA}$ is determined by the user's board design.

(a) $R_{\theta JA} = 86^\circ\text{C/W}$ when mounted on a 1 in² pad of 2 oz copper, 1.5" x 1.5" x 0.062" thick PCB

(b) $R_{\theta JA} = 173^\circ\text{C/W}$ when mounted on a minimum pad of 2 oz copper

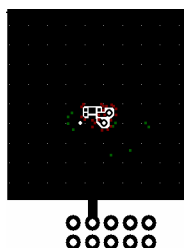

a) 86°C/W when mounted on a 1 in² pad of 2 oz copper

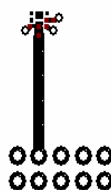

b) 173°C/W when mounted on a minimum pad of 2 oz copper

Scale 1: 1 on letter size paper

2. Pulse Test: Pulse Width < 300 μs , Duty Cycle < 2.0%

ECPW.com.cn 电子產品世界

Typical Characteristics

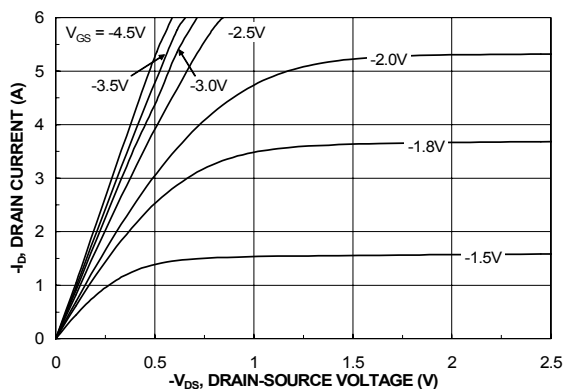

Figure 1. On-Region Characteristics

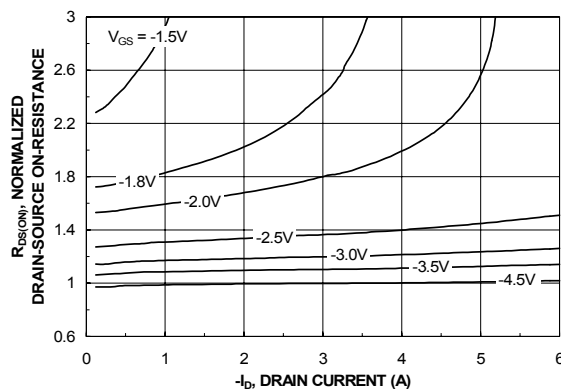

Figure 2. On-Resistance Variation with Drain Current and Gate Voltage

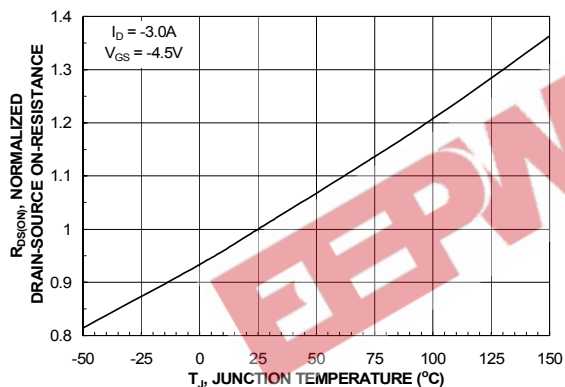

Figure 3. On-Resistance Variation with Temperature

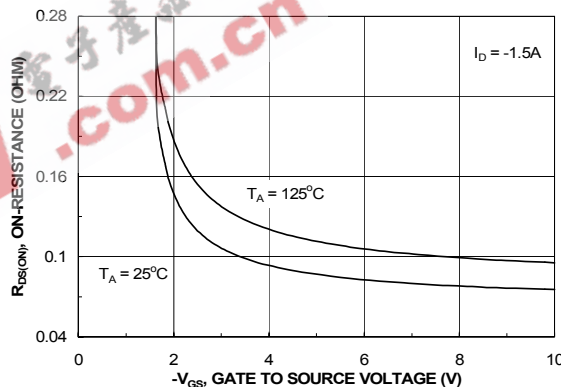

Figure 4. On-Resistance Variation with Gate-to-Source Voltage

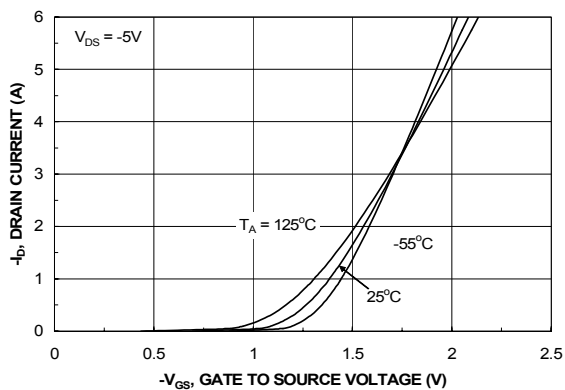

Figure 5. Transfer Characteristics

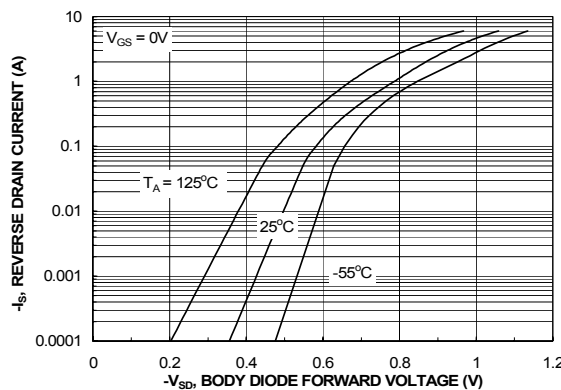

Figure 6. Body Diode Forward Voltage Variation with Source Current and Temperature

Typical Characteristics

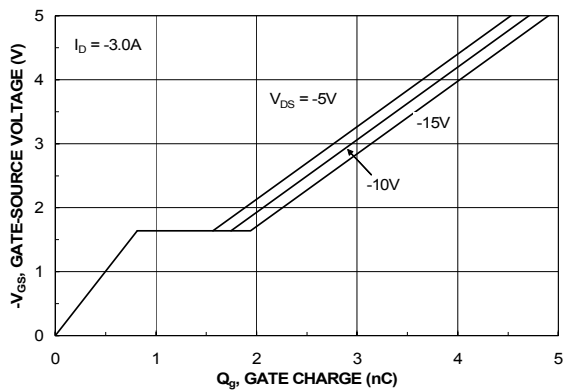

Figure 7. Gate Charge Characteristics

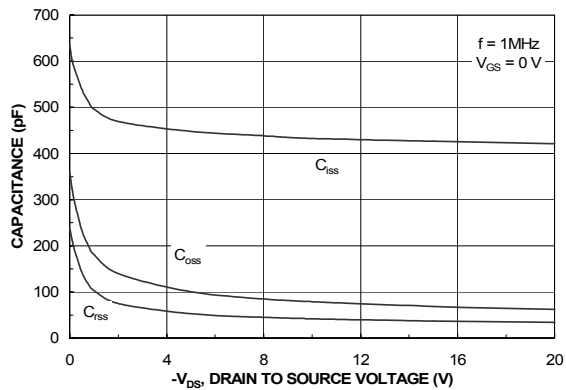

Figure 8. Capacitance Characteristics

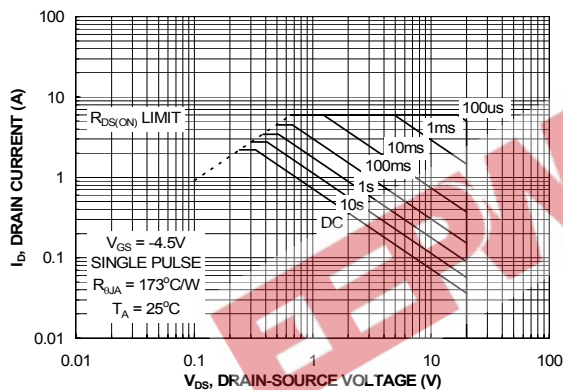

Figure 9. Maximum Safe Operation Area

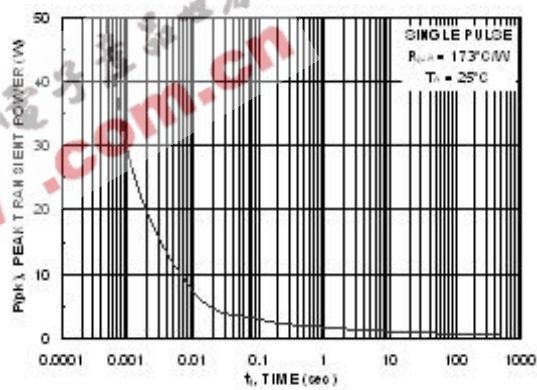

Figure 10. Single Pulse Maximum Power Dissipation

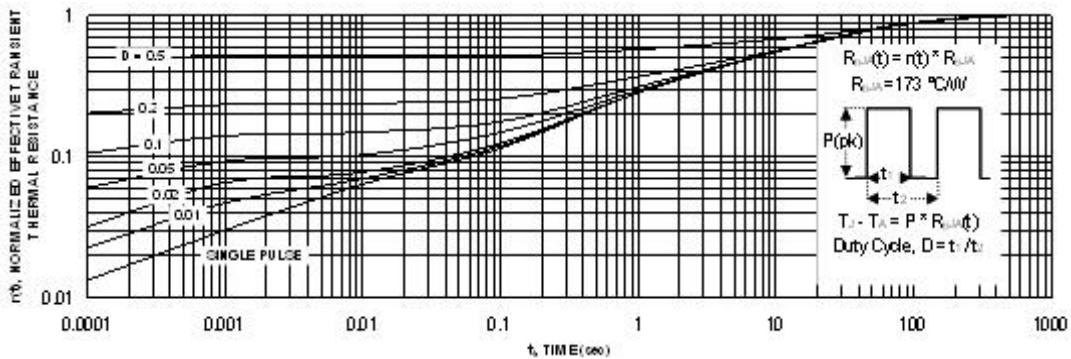
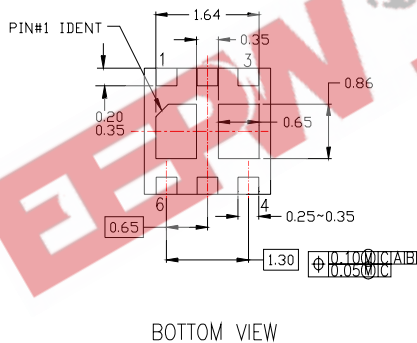
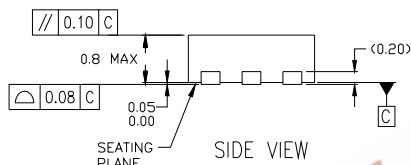
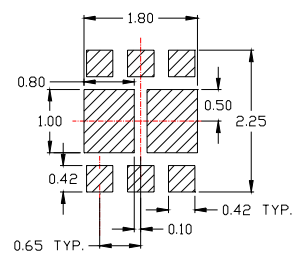
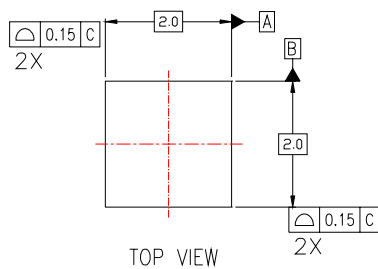

Figure 11. Transient Thermal Response Curve

Thermal characterization performed using the conditions described in Note 1b. Transient thermal response will change depending on the circuit board design.



NOTES:

- A. CONFORMS TO JEDEC REGISTRATION MO-229, VARIATION VCCC, DATED 11/2001
- B. DIMENSIONS ARE IN MILLIMETERS.
- C. DIMENSIONS AND TOLERANCES PER ASME Y14.5M, 1994

MLP06JrevB

TRADEMARKS

The following are registered and unregistered trademarks Fairchild Semiconductor owns or is authorized to use and is not intended to be an exhaustive list of all such trademarks.

ACEx™	FACT™	<i>i-Lo</i> ™	PACMAN™	SPM™
ActiveArray™	FACT Quiet Series™	ImpliedDisconnect™	POP™	Stealth™
Bottomless™	FAST®	IntelliMAX™	Power247™	SuperFET™
Build it Now™	FASTr™	ISOPLANAR™	PowerEdge™	SuperSOT™-3
CoolFET™	FPS™	LittleFET™	PowerSaver™	SuperSOT™-6
CROSSVOLT™	FRFET™	MICROCOUPLER™	PowerTrench®	SuperSOT™-8
DOVE™	GlobalOptoisolator™	MicroFET™	QFET®	SyncFET™
EcoSPARK™	GTO™	MicroPak™	QS™	TinyLogic®
E ² C MOS™	HiSeC™	MICROWIRE™	QT Optoelectronics™	TINYOPTO™
EnSigna™	I ² C™	MSX™	Quiet Series™	TruTranslation™
		MSXPro™	RapidConfigure™	UHC™
Across the board. Around the world.™		OCX™	RapidConnect™	UltraFET®
The Power Franchise®		OCXPro™	µSerDes™	UniFET™
Programmable Active Droop™		OPTOLOGIC®	SILENT SWITCHER®	VCX™
		OPTOPLANAR™	SMART START™	Wire™

DISCLAIMER

FAIRCHILD SEMICONDUCTOR RESERVES THE RIGHT TO MAKE CHANGES WITHOUT FURTHER NOTICE TO ANY PRODUCTS HEREIN TO IMPROVE RELIABILITY, FUNCTION OR DESIGN. FAIRCHILD DOES NOT ASSUME ANY LIABILITY ARISING OUT OF THE APPLICATION OR USE OF ANY PRODUCT OR CIRCUIT DESCRIBED HEREIN; NEITHER DOES IT CONVEY ANY LICENSE UNDER ITS PATENT RIGHTS, NOR THE RIGHTS OF OTHERS.

LIFE SUPPORT POLICY

FAIRCHILD'S PRODUCTS ARE NOT AUTHORIZED FOR USE AS CRITICAL COMPONENTS IN LIFE SUPPORT DEVICES OR SYSTEMS WITHOUT THE EXPRESS WRITTEN APPROVAL OF FAIRCHILD SEMICONDUCTOR CORPORATION.

As used herein:

1. Life support devices or systems are devices or systems which, (a) are intended for surgical implant into the body, or (b) support or sustain life, or (c) whose failure to perform when properly used in accordance with instructions for use provided in the labeling, can be reasonably expected to result in significant injury to the user.
2. A critical component is any component of a life support device or system whose failure to perform can be reasonably expected to cause the failure of the life support device or system, or to affect its safety or effectiveness.

PRODUCT STATUS DEFINITIONS

Definition of Terms

Datasheet Identification	Product Status	Definition
Advance Information	Formative or In Design	This datasheet contains the design specifications for product development. Specifications may change in any manner without notice.
Preliminary	First Production	This datasheet contains preliminary data, and supplementary data will be published at a later date. Fairchild Semiconductor reserves the right to make changes at any time without notice in order to improve design.
No Identification Needed	Full Production	This datasheet contains final specifications. Fairchild Semiconductor reserves the right to make changes at any time without notice in order to improve design.
Obsolete	Not In Production	This datasheet contains specifications on a product that has been discontinued by Fairchild semiconductor. The datasheet is printed for reference information only.

Rev. 116