

# FD TYPE CONNECTOR FOR RIBBON CABLE (1.27-millimeter pitch for standard ribbon cable)

## General

The FD Series connectors are designed for ribbon cable IDC termination. Connecting wires are grouped, so the FD Series are useful for labor-saving in connection work and enhancing wiring reliability.

Being compatible with 1.27-mm (standard) ribbon

cables, the FD Series are general-purpose, high-performance connectors that are capable of being interfacing with connectors for other types of ribbon cables. 9, 15, 25 and 37-contact models available.

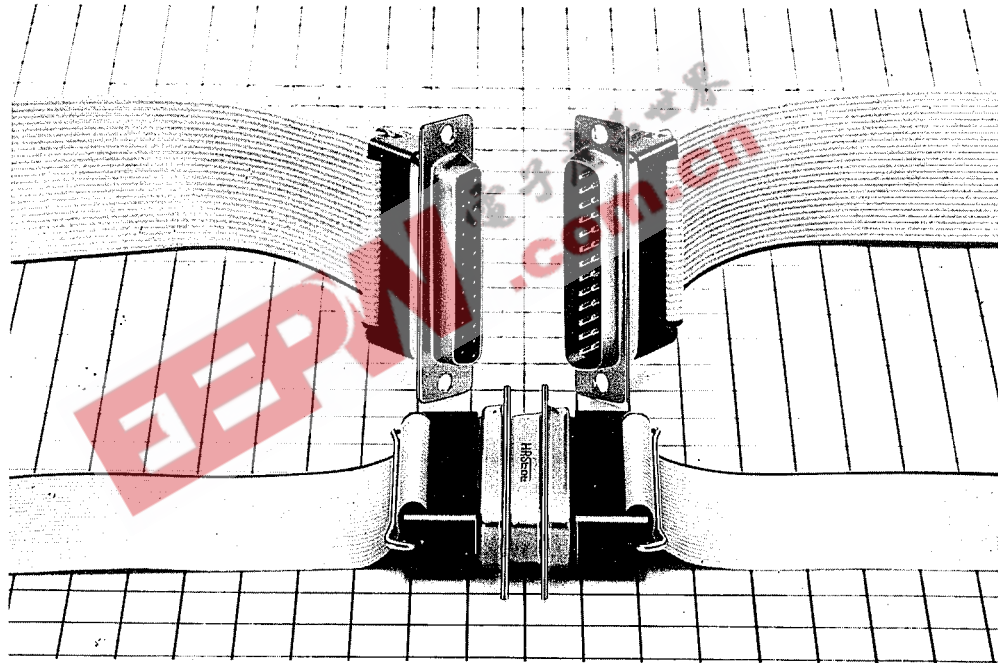

## Features

- (1) Compact and sturdy due to metal shell.
- (2) Can be mounted on the front or back of a panel or chassis as necessary.
- (3) Fixes the cable securely by fixing the ribbon cable clamp with a metal plate in the connector.
- (4) Can be easily connected to a standard ribbon cable, having a cable IDC pitch of 1.27mm (standard).
- (5) Easy to connect cables by following the same IDC termination and connecting procedures as those for our other ribbon cable connectors.

## Applications

Most suitable for modems in communications equipment such as computers, peripherals and terminals, control equipment, and measuring instruments, and export equipment.

## Electrical and Environmental

Electrical and Environmental Characteristics	
Current rating	1A
Voltage rating	AC200V
Insulation resistance	1,000MΩ or higher at DC 500V
Contact resistance	25mΩ or less at DC100mA
Withstand voltage	AC650Vr.m.s. for a minute

Material and Finish		
Shell	Steel	Bichromium Acid Treatment over zincplating
Insulator	PBT(GE Valox)	Black, UL94V-0
Contacts	Copper alloy	Nickel-plating + Gold plating

### Cable specifications

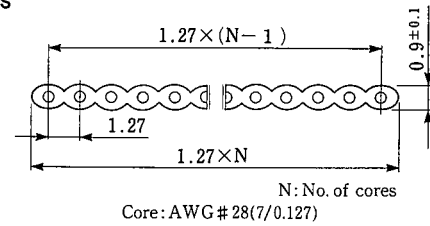

## Ordering Information

FD
B
-
25
P
F
(05)

(1)
(2)
(3)
(4)
(5)
(6)

- (1) Series Name FD: Insulation displacement termination
- (2) Shell size E. A. B. C.
- (3) No. of pin 9, 15, 25, 37
- (4) Type of contacts  
P: Male contact  
S: Female contact
- (5) Shell dimpled (male connector only)
- (6) (05) Nickel-plated shell  
No sign: Treated with dichromate over zinc-plating (only FD\*D-PF shell are solder-plated)

## D Subminiature IDC Male

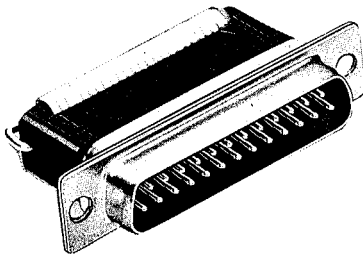

CL211-0135-0  
FDB-25P

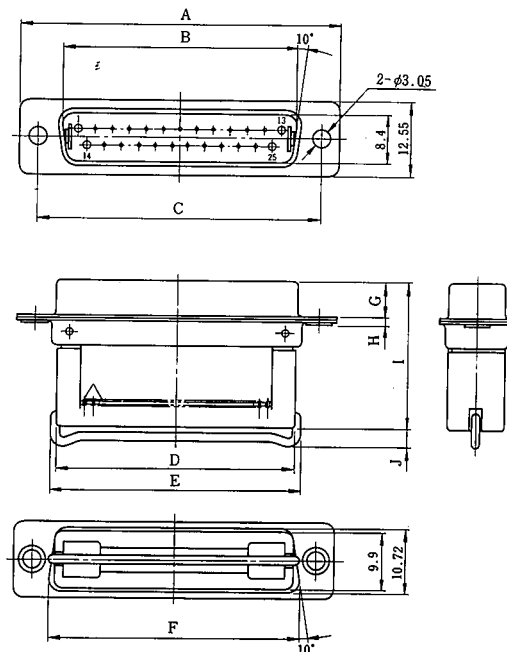

Unit: mm

HRS No.	No. of Pin	Part No.	A	B	C	C	E	F	G	H	I	J
CL211-0143-8	9	FDE-9P	30.81	16.9	24.99	17.6	19	19.28	5.99	1.2	24.39	2.7
CL211-0145-3	15	FDA-15P	39.14	25.24	33.32	25.8	27.2	27.55	5.99	1.2	24.39	2.7
CL211-0135-0	25	FDB-25P	53.04	39.01	47.04	39.6	41.4	41.28	5.87	1.3	24.37	3.2
CL211-0147-9	37	FDC-37P	69.32	55.47	63.5	56.14	57.9	57.71	5.87	1.4	24.47	3.2

## D Subminiature IDC, Male with Grounding Dimples

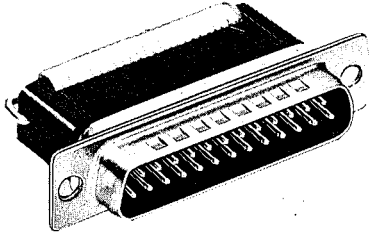

CL211-0723-8-05  
FDB-25PF(05)

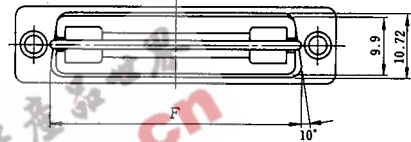
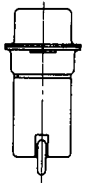
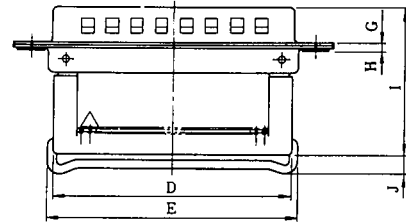
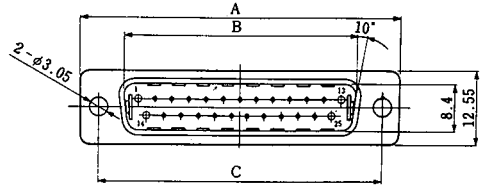

Unit: mm

HRS No.	No. of Pin	Part No.	A	B	C	D	E	F	G	H	I	J
CL211-0721-2-05	9	FDE-9PE(05)	30.81	16.9	24.99	17.6	19	19.28	5.99	1.2	24.39	2.7
CL211-0722-5-05	15	FDA-15PF(05)	39.14	25.24	33.32	25.8	27.2	27.55	5.99	1.2	24.39	2.7
CL211-0723-8-05	25	FDB-25PF(05)	53.04	39.01	47.04	39.6	41.4	41.28	5.87	1.3	24.37	3.2
CL211-0724-0-05	37	FDC-37PF(05)	69.32	55.47	63.5	56.14	57.9	57.71	5.87	1.4	24.47	3.2

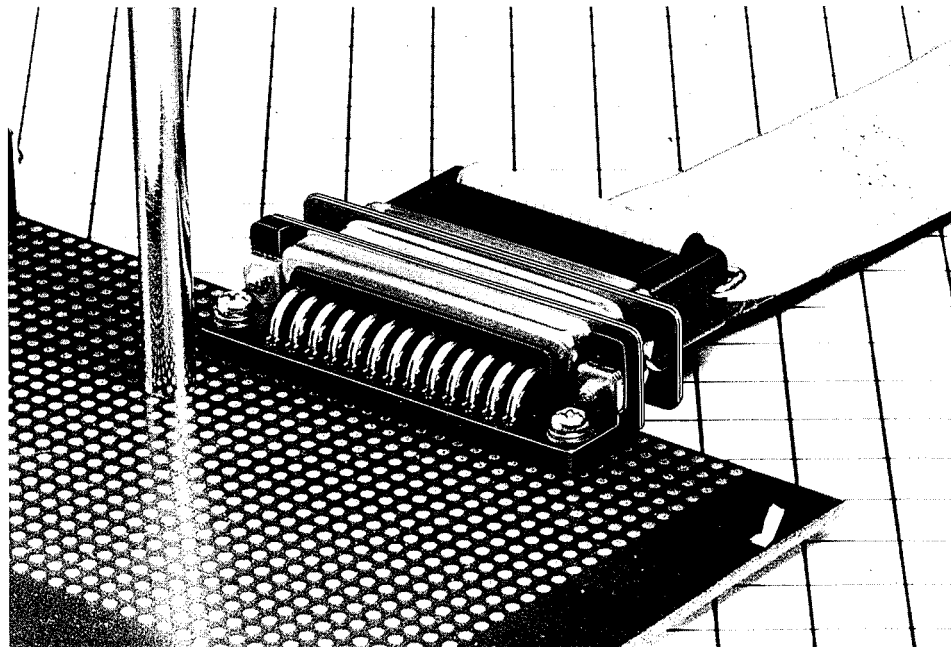

## Subminiature IDC Female

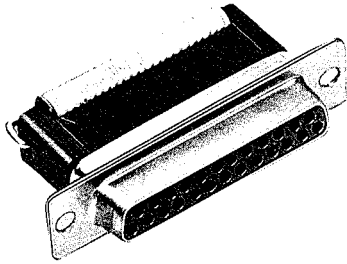

CL211-0136-2  
FDB-25S

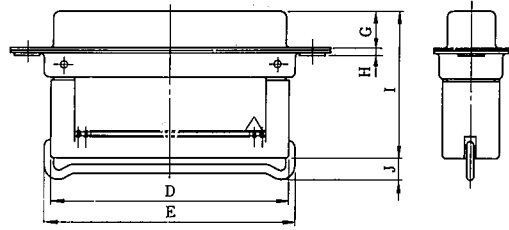
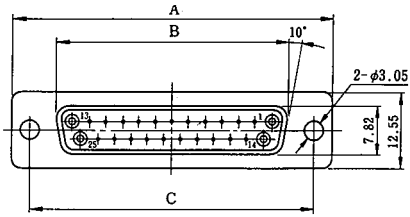

Unit: mm

HGS.No.	No. of pin	Part No.	A	B	C	D	E	F	G	H	I	J
CL211-0144-0	9	FDE-9S	30.81	16.4	24.99	17.6	19	19.28	6.17	1.2	24.37	2.7
CL211-0146-6	15	FDA-15S	39.14	24.59	33.32	25.8	27.2	27.55	6.17	1.2	24.37	2.7
CL211-0136-2	25	FDB-25S	53.04	38.3	47.04	39.6	41.4	41.28	6.17	1.2	24.37	3.2
CL211-0148-1	37	FDC-37S	69.32	54.76	63.5	56.14	57.9	57.71	6.17	1.2	24.37	3.2

Nickel-plated shells have (05) added to the part numbers.

## Connector Mounting Method and Mounting Dimensions

### ▶ Connector mounted on the face of the panel (front mounting)

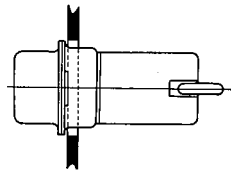
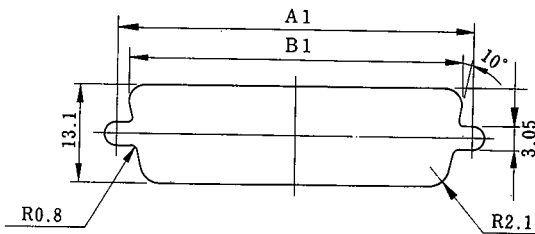

Unit: mm

Shell size	A1	B1
E	24.99	22
A	33.32	30.3
B	47.04	44
C	63.5	60.5

### ▶ Connector mounted on the back of the panel (rear mounting)

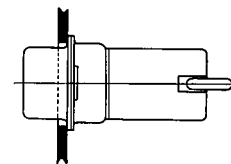
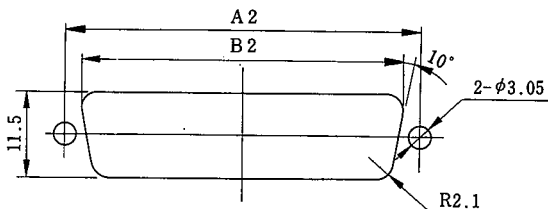

Rear Mounting

Unit: mm

Shell size	A2	B2
E	24.99	20.2
A	33.32	28.6
B	47.04	42.5
C	63.5	59.2

# Cabling Variations

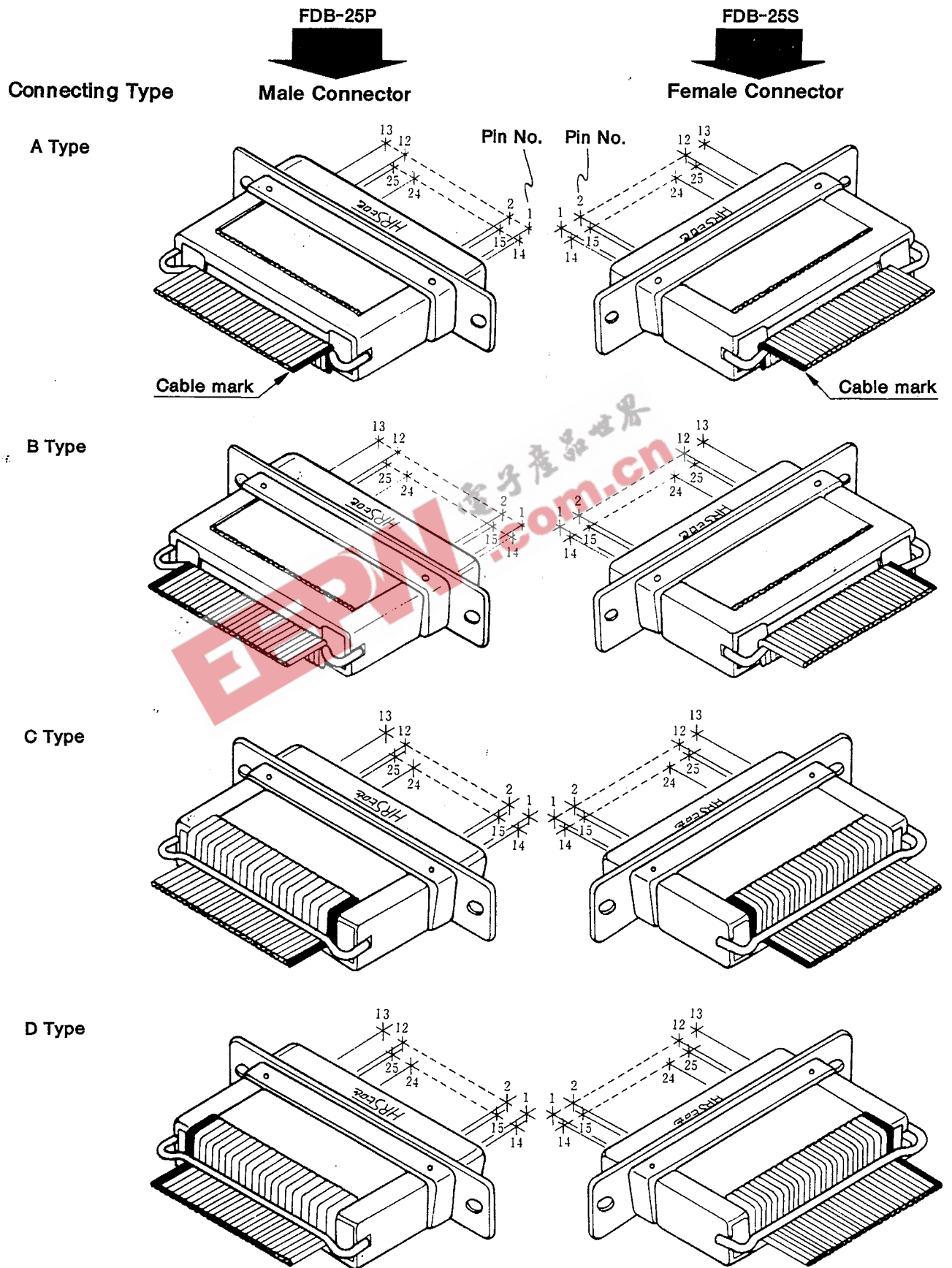

## Tools

### Hi-Flex Connecting Press

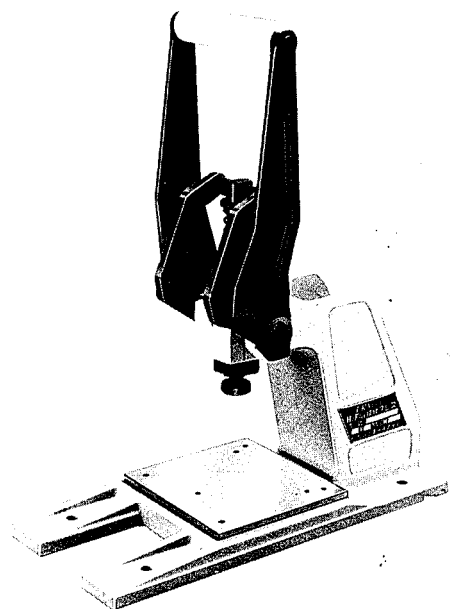

HRS No.	Part No.	Height	Width	Depth	Weight
550-0082-2	Hi-Flex connecting press	440mm	160mm	350mm	13kg

### Guide Plate

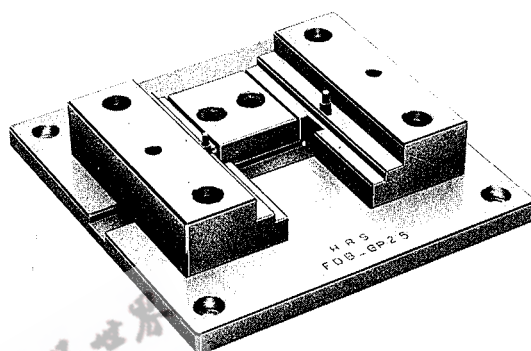

HRS No.	Part No.
902-0008-9	FDE-GP
902-0011-3	FDA-GP
902-0005-0	FDB-GP
902-0014-1	FDC-GP

### Pressure Block (For Plug)

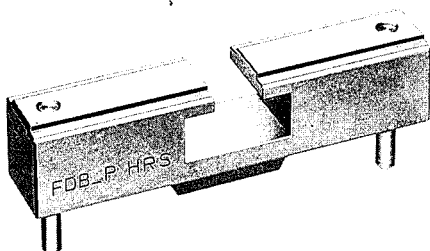

HRS No.	Part No.
902-0006-3	FDE-P pressure block
902-0009-1	FDA-P pressure block
902-0003-5	FDB-P pressure block
902-0012-6	FDC-P pressure block

### Pressure Block (For Socket)

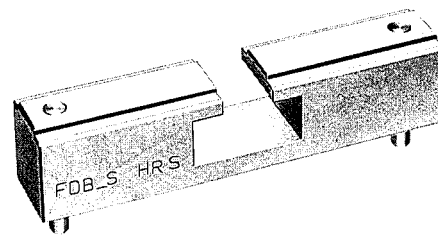

HRS No.	Part No.
902-0007-6	FDE-S pressure block
902-0010-0	FDA-S pressure block
902-0004-8	FDB-S pressure block
902-0013-9	FDC-S pressure block