

## FDP33N25 / FDPF33N25 250V N-Channel MOSFET

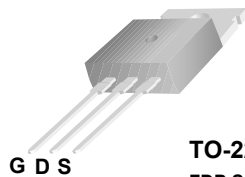
### Features

- 33A, 250V,  $R_{DS(on)} = 0.094\Omega @ V_{GS} = 10V$
- Low gate charge ( typical 36.8 nC)
- Low Crss ( typical 39 pF)
- Fast switching
- Improved dv/dt capability

### Description

These N-Channel enhancement mode power field effect transistors are produced using Fairchild's proprietary, planar stripe, DMOS technology.

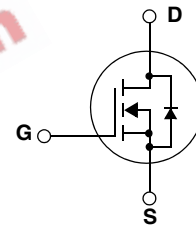
This advanced technology has been especially tailored to minimize on-state resistance, provide superior switching performance, and withstand high energy pulse in the avalanche and commutation mode. These devices are well suited for high efficient switched mode power supplies and active power factor correction.



**TO-220**  
FDP Series



**TO-220F**  
FDPF Series



### Absolute Maximum Ratings

Symbol	Parameter	FDP33N25	FDPF33N25	Unit
$V_{DSS}$	Drain-Source Voltage	250		V
$I_D$	Drain Current	- Continuous ( $T_C = 25^\circ\text{C}$ )	33	33*
		- Continuous ( $T_C = 100^\circ\text{C}$ )	20.4	20.4*
$I_{DM}$	Drain Current - Pulsed (Note 1)	132	132*	A
$V_{GSS}$	Gate-Source voltage	$\pm 30$		V
$E_{AS}$	Single Pulsed Avalanche Energy (Note 2)	918		mJ
$I_{AR}$	Avalanche Current (Note 1)	33		A
$E_{AR}$	Repetitive Avalanche Energy (Note 1)	23.5		mJ
dv/dt	Peak Diode Recovery dv/dt (Note 3)	4.5		V/ns
$P_D$	Power Dissipation ( $T_C = 25^\circ\text{C}$ )	- Derate above $25^\circ\text{C}$	235	37
			1.89	0.29
$T_J, T_{STG}$	Operating and Storage Temperature Range	-55 to +150		$^\circ\text{C}$
$T_L$	Maximum Lead Temperature for Soldering Purpose, 1/8" from Case for 5 Seconds	300		$^\circ\text{C}$

\*Drain current limited by maximum junction temperature

### Thermal Characteristics

Symbol	Parameter	FDP33N25	FDPF33N25	Unit
$R_{\theta JC}$	Thermal Resistance, Junction-to-Case	0.53	3.4	$^\circ\text{C/W}$
$R_{\theta CS}$	Thermal Resistance, Case-to-Sink Typ.	0.5	--	$^\circ\text{C/W}$
$R_{\theta JA}$	Thermal Resistance, Junction-to-Ambient	62.5	62.5	$^\circ\text{C/W}$

## Package Marking and Ordering Information

Device Marking	Device	Package	Reel Size	Tape Width	Quantity
FDP33N25	FDP33N25	TO-220	-	-	50
FDPF33N25	FDPF33N25	TO-220F	-	-	50

## Electrical Characteristics T<sub>C</sub> = 25°C unless otherwise noted

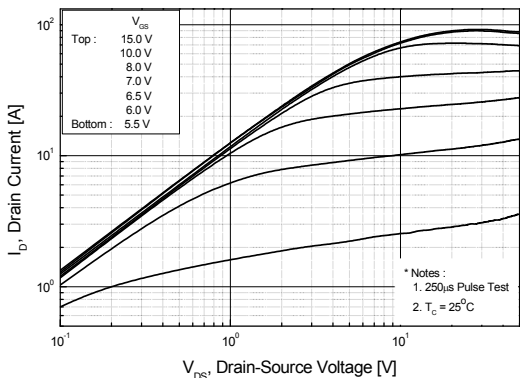
Symbol	Parameter	Conditions	Min	Typ	Max	Units
<b>Off Characteristics</b>						
BV <sub>DSS</sub>	Drain-Source Breakdown Voltage	V <sub>GS</sub> = 0V, I <sub>D</sub> = 250μA, T <sub>J</sub> = 25°C	250	--	--	V
ΔBV <sub>DSS</sub> / ΔT <sub>J</sub>	Breakdown Voltage Temperature Coefficient	I <sub>D</sub> = 250μA, Referenced to 25°C	--	0.25	--	V/°C
I <sub>DSS</sub>	Zero Gate Voltage Drain Current	V <sub>DS</sub> = 250V, V <sub>GS</sub> = 0V V <sub>DS</sub> = 200V, T <sub>C</sub> = 125°C	--	--	1	μA
I <sub>GSSF</sub>	Gate-Body Leakage Current, Forward	V <sub>GS</sub> = 30V, V <sub>DS</sub> = 0V	--	--	100	nA
I <sub>GSSR</sub>	Gate-Body Leakage Current, Reverse	V <sub>GS</sub> = -30V, V <sub>DS</sub> = 0V	--	--	-100	nA
<b>On Characteristics</b>						
V <sub>GS(th)</sub>	Gate Threshold Voltage	V <sub>DS</sub> = V <sub>GS</sub> , I <sub>D</sub> = 250μA	3.0	--	5.0	V
R <sub>DS(on)</sub>	Static Drain-Source On-Resistance	V <sub>GS</sub> = 10V, I <sub>D</sub> = 16.5A	--	0.077	0.094	Ω
g <sub>FS</sub>	Forward Transconductance	V <sub>DS</sub> = 40V, I <sub>D</sub> = 16.5A (Note 4)	--	26.6	--	S
<b>Dynamic Characteristics</b>						
C <sub>iss</sub>	Input Capacitance	V <sub>DS</sub> = 25V, V <sub>GS</sub> = 0V, f = 1.0MHz	--	1640	2135	pF
C <sub>oss</sub>	Output Capacitance		--	330	430	pF
C <sub>rss</sub>	Reverse Transfer Capacitance		--	39	59	pF
<b>Switching Characteristics</b>						
t <sub>d(on)</sub>	Turn-On Delay Time	V <sub>DD</sub> = 125V, I <sub>D</sub> = 33A R <sub>G</sub> = 25Ω  (Note 4, 5)	--	35	80	ns
t <sub>r</sub>	Turn-On Rise Time		--	230	470	ns
t <sub>d(off)</sub>	Turn-Off Delay Time		--	75	160	ns
t <sub>f</sub>	Turn-Off Fall Time		--	120	250	ns
Q <sub>g</sub>	Total Gate Charge	V <sub>DS</sub> = 200V, I <sub>D</sub> = 33A V <sub>GS</sub> = 10V  (Note 4, 5)	--	36.8	48	nC
Q <sub>gs</sub>	Gate-Source Charge		--	10	--	nC
Q <sub>gd</sub>	Gate-Drain Charge		--	17	--	nC
<b>Drain-Source Diode Characteristics and Maximum Ratings</b>						
I <sub>S</sub>	Maximum Continuous Drain-Source Diode Forward Current		--	--	33	A
I <sub>SM</sub>	Maximum Pulsed Drain-Source Diode Forward Current		--	--	132	A
V <sub>SD</sub>	Drain-Source Diode Forward Voltage	V <sub>GS</sub> = 0V, I <sub>S</sub> = 33A	--	--	1.4	V
t <sub>rr</sub>	Reverse Recovery Time	V <sub>GS</sub> = 0V, I <sub>S</sub> = 33A di <sub>F</sub> /dt = 100A/μs  (Note 4)	--	220	--	ns
Q <sub>rr</sub>	Reverse Recovery Charge		--	1.71	--	μC

### Notes:

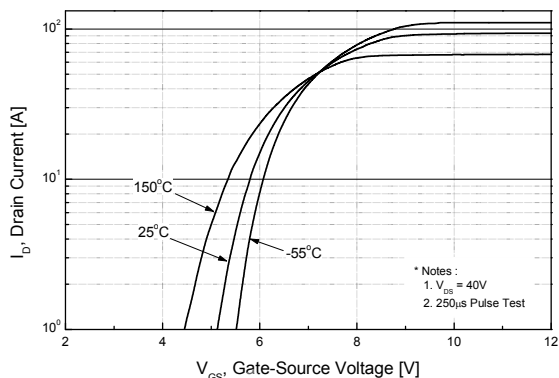
1. Repetitive Rating: Pulse width limited by maximum junction temperature
2. L = 1.35mH, I<sub>AS</sub> = 33A, V<sub>DD</sub> = 50V, R<sub>G</sub> = 25Ω, Starting T<sub>J</sub> = 25°C
3. I<sub>SD</sub> ≤ 33A, di/dt ≤ 200A/μs, V<sub>DD</sub> ≤ BV<sub>DSS</sub>, Starting T<sub>J</sub> = 25°C
4. Pulse Test: Pulse width ≤ 300μs, Duty Cycle ≤ 2%
5. Essentially Independent of Operating Temperature Typical Characteristics

## Typical Performance Characteristics

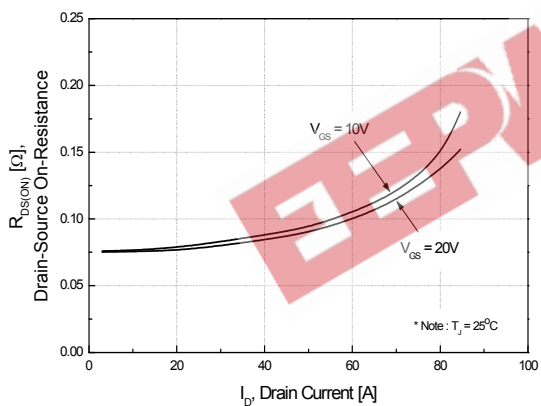
**Figure 1. On-Region Characteristics**



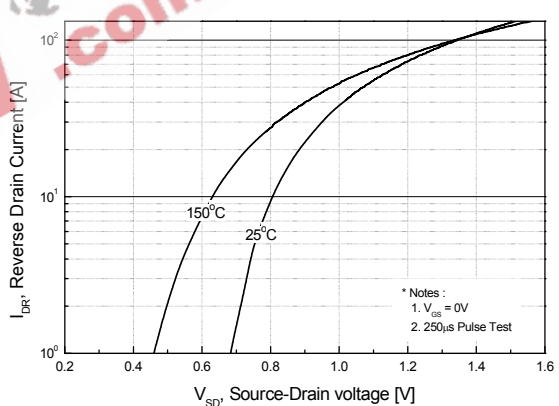
**Figure 2. Transfer Characteristics**



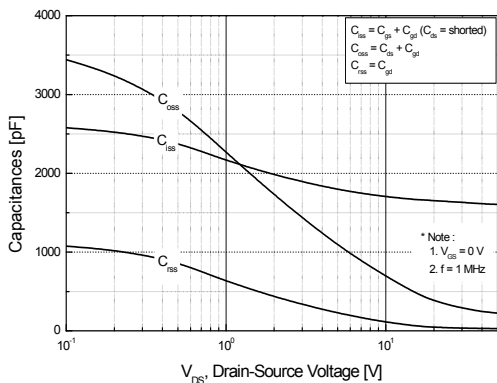
**Figure 3. On-Resistance Variation vs. Drain Current and Gate Voltage**



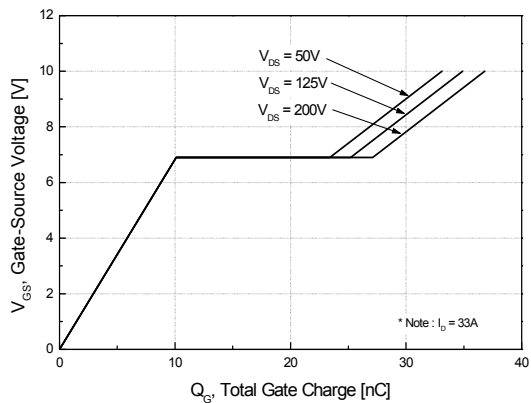
**Figure 4. Body Diode Forward Voltage Variation vs. Source Current and Temperature**



**Figure 5. Capacitance Characteristics**

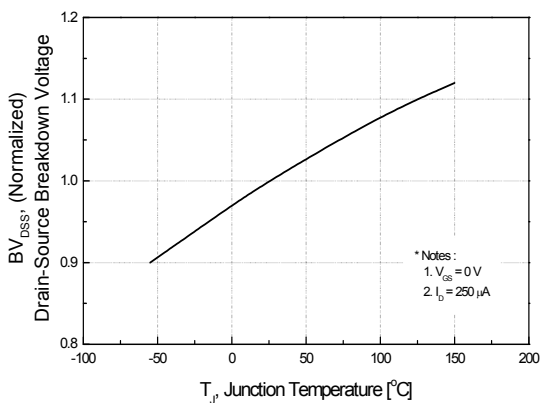


**Figure 6. Gate Charge Characteristics**

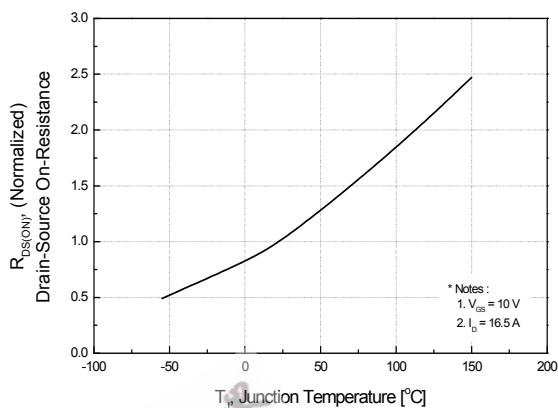


**Typical Performance Characteristics** (Continued)

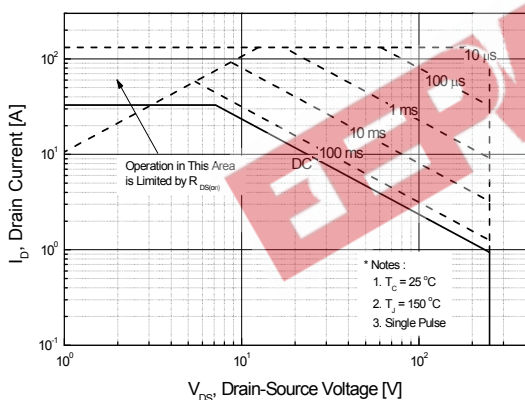
**Figure 7. Breakdown Voltage Variation vs. Temperature**



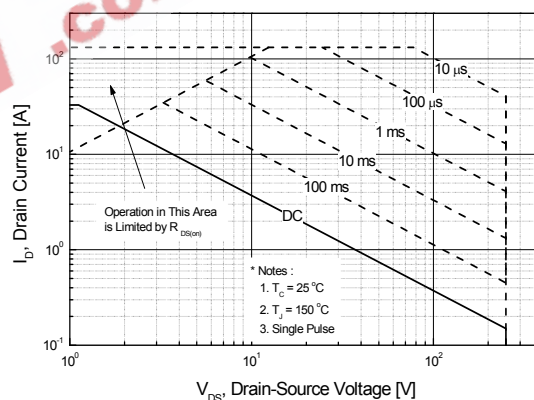
**Figure 8. On-Resistance Variation vs. Temperature**



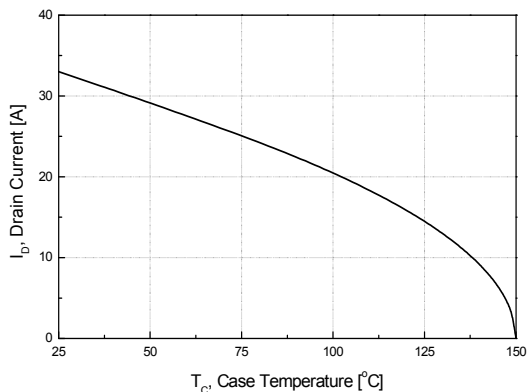
**Figure 9-1. Maximum Safe Operating Area for FDP33N25**



**Figure 9-2. Maximum Safe Operating Area for FDPF33N25**



**Figure 10. Maximum Drain Current vs. Case Temperature**



Typical Performance Characteristics (Continued)

Figure 11-1. Transient Thermal Response Curve for FDP33N25

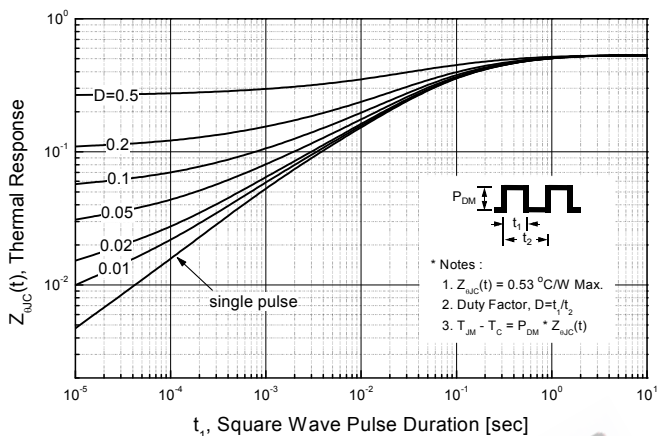
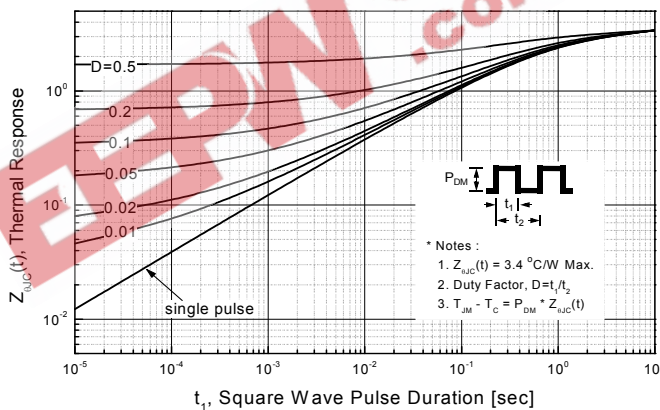
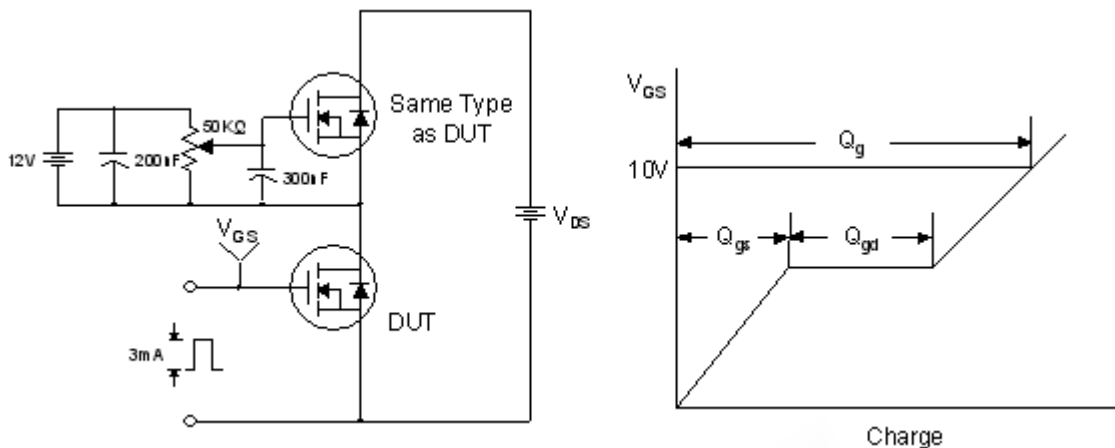


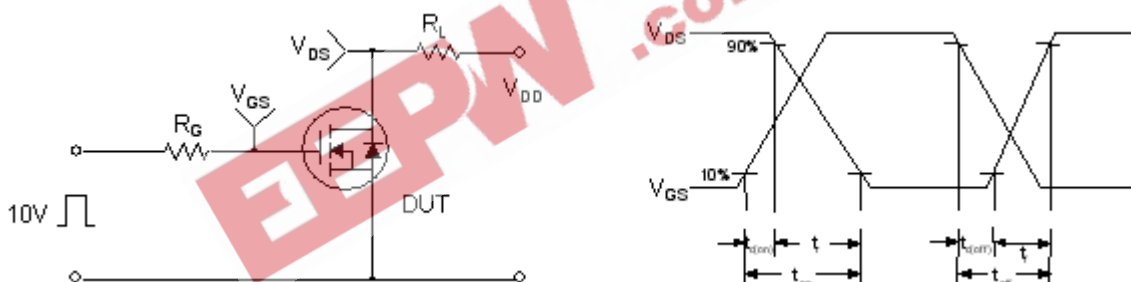
Figure 11-2. Transient Thermal Response Curve for FDPF33N25



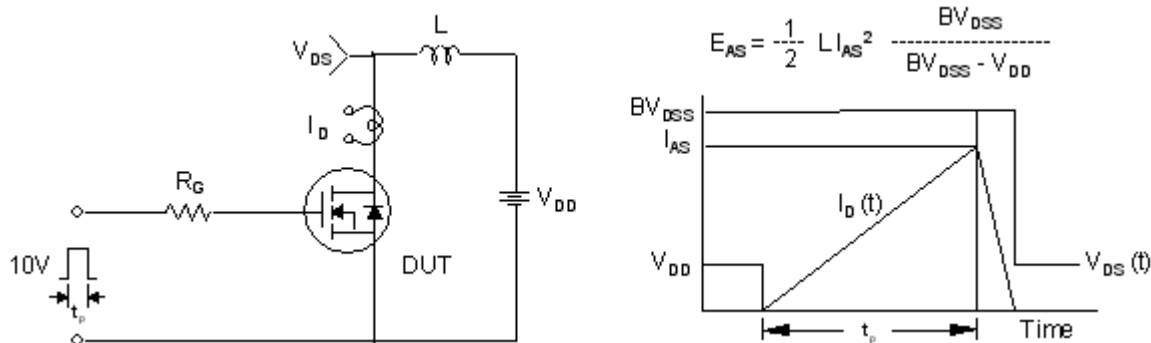
**Gate Charge Test Circuit & Waveform**



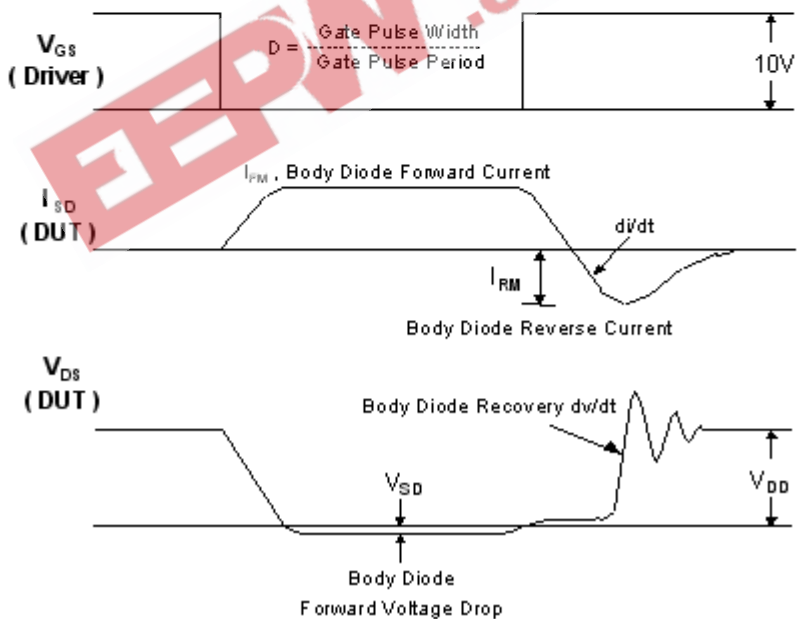
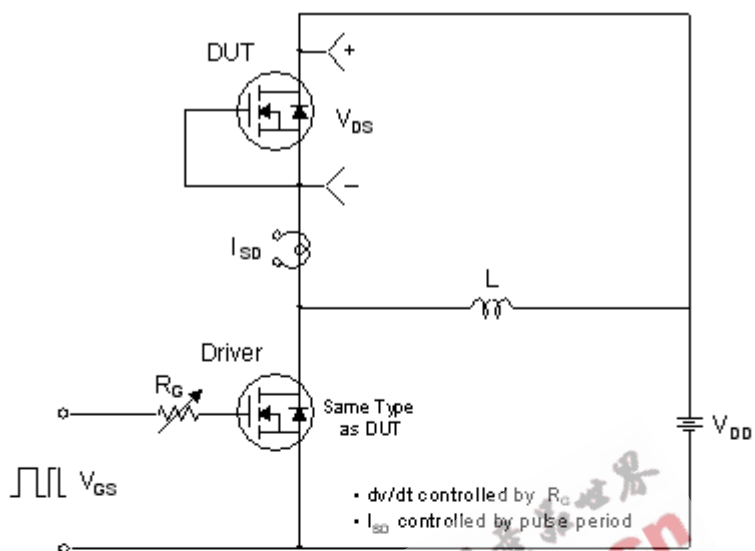
**Resistive Switching Test Circuit & Waveforms**



**Unclamped Inductive Switching Test Circuit & Waveforms**

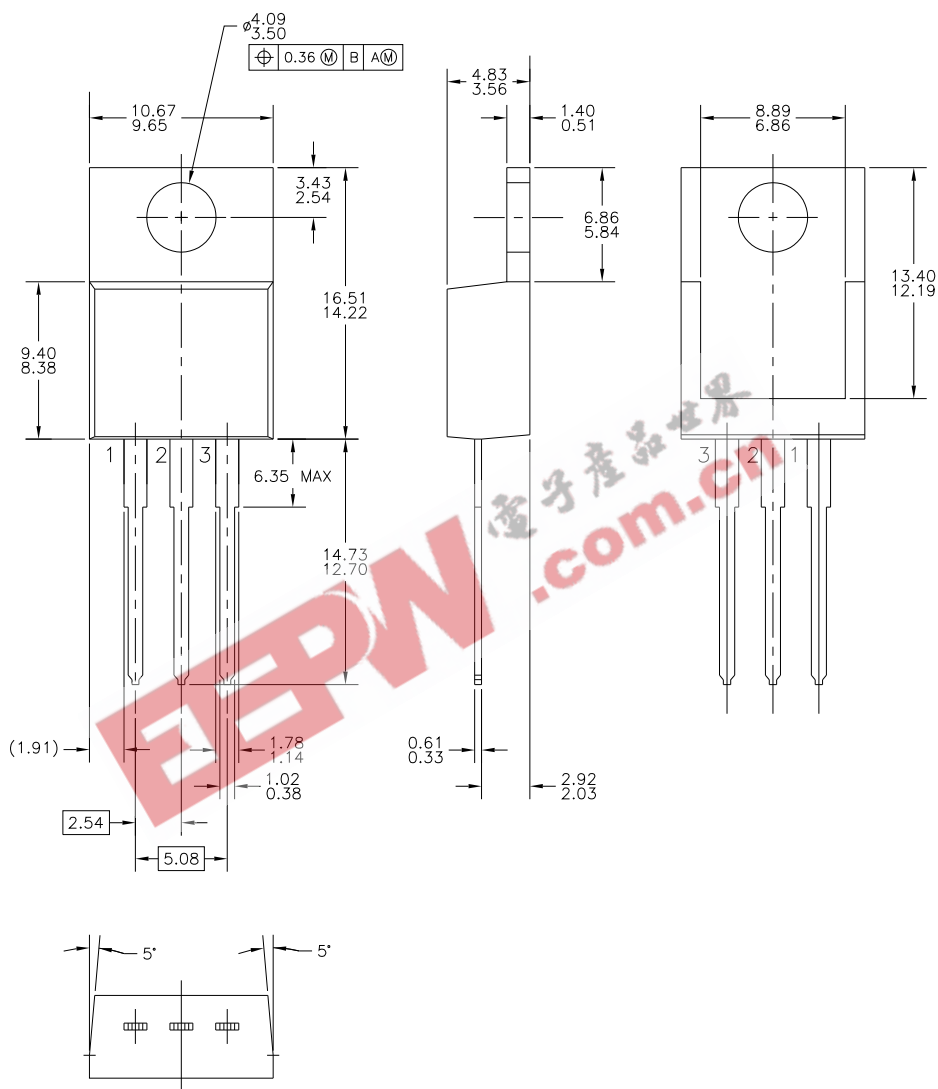


Peak Diode Recovery dv/dt Test Circuit & Waveforms



Mechanical Dimensions

TO-220

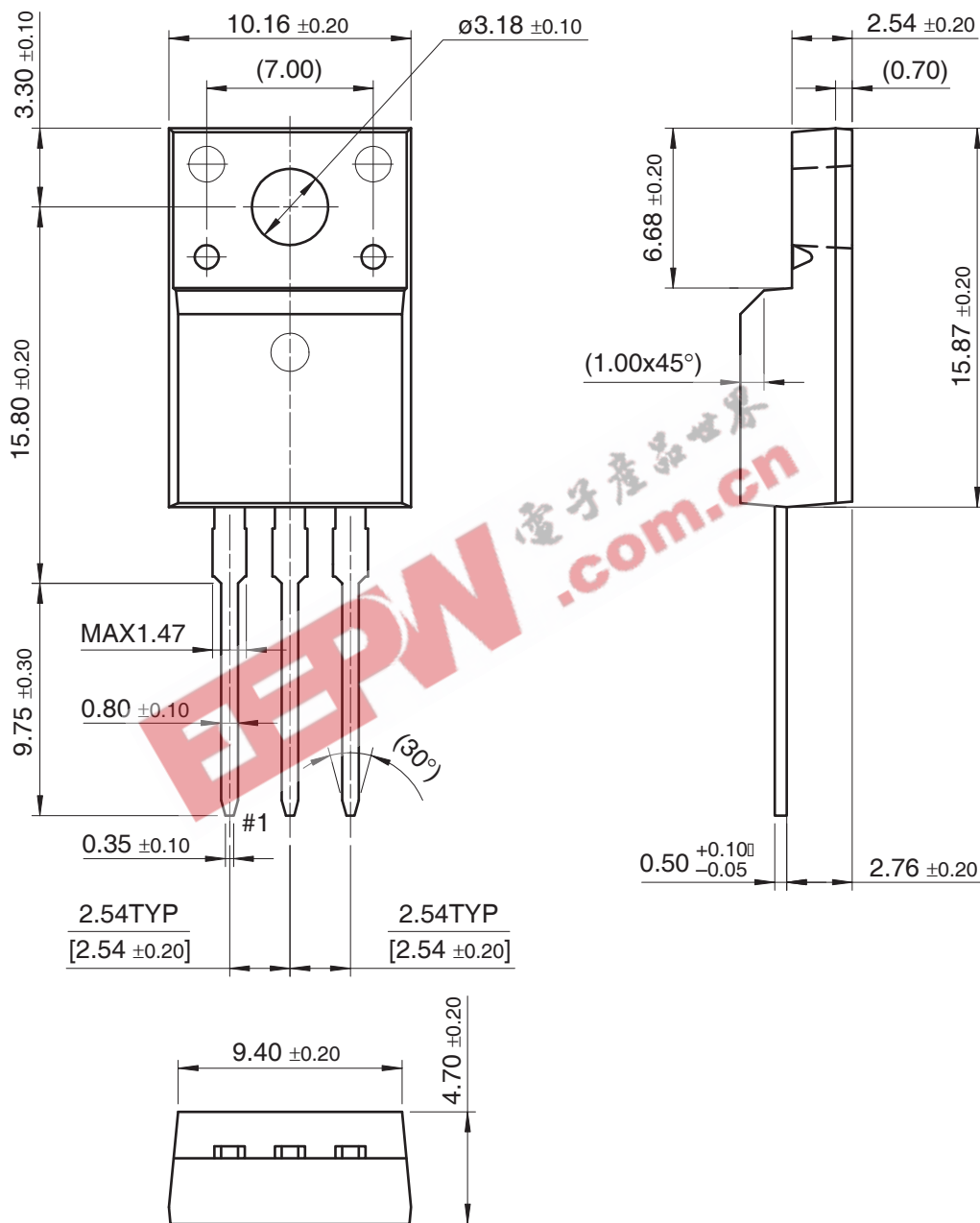


Dimensions in Millimeters



Mechanical Dimensions (Continued)

TO-220F



Dimensions in Millimeters



**TRADEMARKS**

The following are registered and unregistered trademarks Fairchild Semiconductor owns or is authorized to use and is not intended to be an exhaustive list of all such trademarks.

- |                                      |                    |                            |                 |
|--------------------------------------|--------------------|----------------------------|-----------------|
| ACEX®                                | <i>i-Lo</i> ™      | Power-SPM™                 | TinyBoost™      |
| Across the board. Around the world.™ | ImpliedDisconnect™ | PowerTrench®               | TinyBuck™       |
| ActiveArray™                         | IntelliMAX™        | Programmable Active Droop™ | TinyLogic®      |
| Bottomless™                          | ISOPLANAR™         | QFET®                      | TINYOPTO™       |
| Build it Now™                        | MICROCOUPLER™      | QS™                        | TinyPower™      |
| CoolFET™                             | MicroPak™          | QT Optoelectronics™        | TinyWire™       |
| CROSSVOLT™                           | MICROWIRE™         | Quiet Series™              | TruTranslation™ |
| CTL™                                 | Motion-SPM™        | RapidConfigure™            | µSerDes™        |
| Current Transfer Logic™              | MSX™               | RapidConnect™              | UHC®            |
| DOME™                                | MSXPro™            | ScalarPump™                | UniFET™         |
| E <sup>2</sup> CMOS™                 | OCX™               | SMART START™               | VCX™            |
| EcoSPARK®                            | OCXPro™            | SPM®                       | Wire™           |
| EnSigna™                             | OPTOLOGIC®         | STEALTH™                   |                 |
| FACT Quiet Series™                   | OPTOPLANAR®        | SuperFET™                  |                 |
| FACT®                                | PACMAN™            | SuperSOT™-3                |                 |
| FAST®                                | PDP-SPM™           | SuperSOT™-6                |                 |
| FASTr™                               | POP™               | SuperSOT™-8                |                 |
| FPS™                                 | Power220®          | SyncFET™                   |                 |
| FRFET®                               | Power247®          | TCM™                       |                 |
| GlobalOptoisolator™                  | PowerEdge™         | The Power Franchise®       |                 |
| GTO™                                 | PowerSaver™        |                            |                 |
| HiSeC™                               |                    |                            |                 |

**DISCLAIMER**

FAIRCHILD SEMICONDUCTOR RESERVES THE RIGHT TO MAKE CHANGES WITHOUT FURTHER NOTICE TO ANY PRODUCTS HEREIN TO IMPROVE RELIABILITY, FUNCTION OR DESIGN. FAIRCHILD DOES NOT ASSUME ANY LIABILITY ARISING OUT OF THE APPLICATION OR USE OF ANY PRODUCT OR CIRCUIT DESCRIBED HEREIN; NEITHER DOES IT CONVEY ANY LICENSE UNDER ITS PATENT RIGHTS, NOR THE RIGHTS OF OTHERS. THESE SPECIFICATIONS DO NOT EXPAND THE TERMS OF FAIRCHILD'S WORLDWIDE TERMS AND CONDITIONS, SPECIFICALLY THE WARRANTY THEREIN, WHICH COVERS THESE PRODUCTS.

**LIFE SUPPORT POLICY**

FAIRCHILD'S PRODUCTS ARE NOT AUTHORIZED FOR USE AS CRITICAL COMPONENTS IN LIFE SUPPORT DEVICES OR SYSTEMS WITHOUT THE EXPRESS WRITTEN APPROVAL OF FAIRCHILD SEMICONDUCTOR CORPORATION.

As used herein:

- Life support devices or systems are devices or systems which, (a) are intended for surgical implant into the body or (b) support or sustain life, and (c) whose failure to perform when properly used in accordance with instructions for use provided in the labeling, can be reasonably expected to result in a significant injury of the user.
- A critical component in any component of a life support, device, or system whose failure to perform can be reasonably expected to cause the failure of the life support device or system, or to affect its safety or effectiveness.

**PRODUCT STATUS DEFINITIONS**

**Definition of Terms**

Datasheet Identification	Product Status	Definition
Advance Information	Formative or In Design	This datasheet contains the design specifications for product development. Specifications may change in any manner without notice.
Preliminary	First Production	This datasheet contains preliminary data; supplementary data will be published at a later date. Fairchild Semiconductor reserves the right to make changes at any time without notice to improve design.
No Identification Needed	Full Production	This datasheet contains final specifications. Fairchild Semiconductor reserves the right to make changes at any time without notice to improve design.
Obsolete	Not In Production	This datasheet contains specifications on a product that has been discontinued by Fairchild Semiconductor. The datasheet is printed for reference information only.

Rev. I26