

# FD TYPE CONNECTOR FOR RIBBON CABLE (1.27-millimeter pitch for standard ribbon cable)

## General

The FD Series connectors are designed for ribbon cable IDC termination. Connecting wires are grouped, so the FD Series are useful for labor-saving in connection work and enhancing wiring reliability. Being compatible with 1.27-mm (standard) ribbon

cables, the FD Series are general-purpose, high-performance connectors that are capable of being interfacing with connectors for other types of ribbon cables. 9, 15, 25 and 37-contact models available.

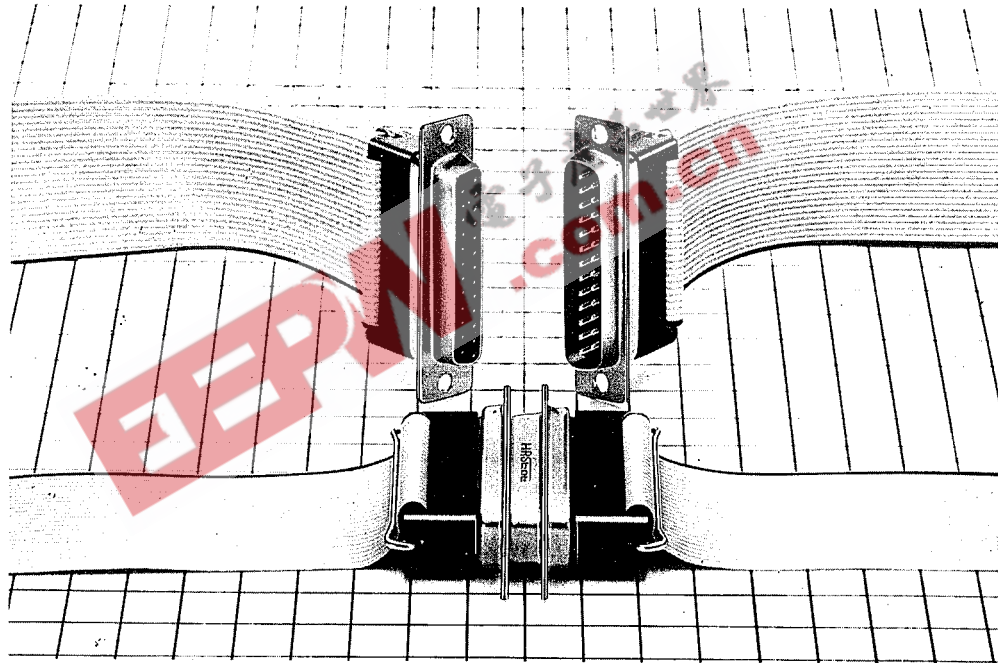

## Features

- (1) Compact and sturdy due to metal shell.
- (2) Can be mounted on the front or back of a panel or chassis as necessary.
- (3) Fixes the cable securely by fixing the ribbon cable clamp with a metal plate in the connector.
- (4) Can be easily connected to a standard ribbon cable, having a cable IDC pitch of 1.27mm (standard).
- (5) Easy to connect cables by following the same IDC termination and connecting procedures as those for our other ribbon cable connectors.

## Applications

Most suitable for modems in communications equipment such as computers, peripherals and terminals, control equipment, and measuring instruments, and export equipment.

## Electrical and Environmental

Electrical and Environmental Characteristics	
Current rating	1A
Voltage rating	AC200V
Insulation resistance	1,000M $\Omega$ or higher at DC 500V
Contact resistance	25m $\Omega$ or less at DC100mA
Withstand voltage	AC650Vr.m.s. for a minute

Material and Finish		
Shell	Steel	Bichromium Acid Treatment over zincplating
Insulator	PBT(GE Valox)	Black, UL94V-0
Contacts	Copper alloy	Nickel-plating + Gold plating

### Cable specifications

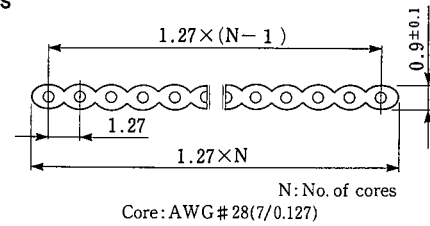

### Ordering Information

FD
B
-
25
P
F
(05)

(1)
(2)
(3)
(4)
(5)
(6)

- (1) Series Name FD: Insulation displacement termination
- (2) Shell size E. A. B. C.
- (3) No. of pin 9, 15, 25, 37
- (4) Type of contacts  
P: Male contact  
S: Female contact
- (5) Shell dimpled (male connector only)
- (6) (05) Nickel-plated shell  
No sign: Treated with dichromate over zinc-plating (only FD\*D-PF shell are solder-plated)

## D Subminiature IDC Male

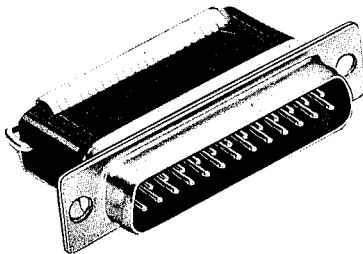

CL211-0135-0  
FDB-25P

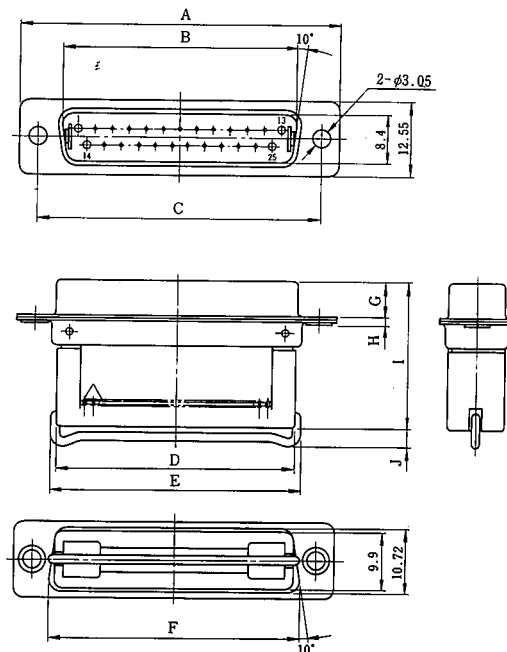

Unit: mm

HRS No.	No. of Pin	Part No.	A	B	C	C	E	F	G	H	I	J
CL211-0143-8	9	FDE-9P	30.81	16.9	24.99	17.6	19	19.28	5.99	1.2	24.39	2.7
CL211-0145-3	15	FDA-15P	39.14	25.24	33.32	25.8	27.2	27.55	5.99	1.2	24.39	2.7
CL211-0135-0	25	FDB-25P	53.04	39.01	47.04	39.6	41.4	41.28	5.87	1.3	24.37	3.2
CL211-0147-9	37	FDC-37P	69.32	55.47	63.5	56.14	57.9	57.71	5.87	1.4	24.47	3.2

## D Subminiature IDC, Male with Grounding Dimples

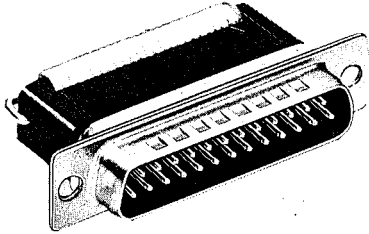

CL211-0723-8-05  
FDB-25PF(05)

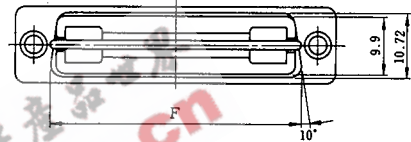
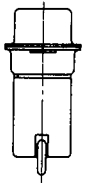
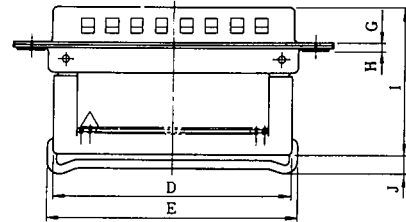
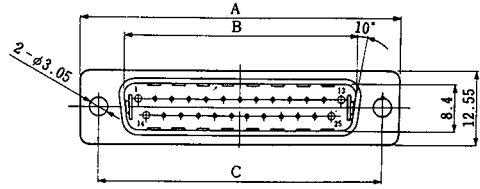

Unit: mm

HRS No.	No. of Pin	Part No.	A	B	C	D	E	F	G	H	I	J
CL211-0721-2-05	9	FDE-9PE(05)	30.81	16.9	24.99	17.6	19	19.28	5.99	1.2	24.39	2.7
CL211-0722-5-05	15	FDA-15PF(05)	39.14	25.24	33.32	25.8	27.2	27.55	5.99	1.2	24.39	2.7
CL211-0723-8-05	25	FDB-25PF(05)	53.04	39.01	47.04	39.6	41.4	41.28	5.87	1.3	24.37	3.2
CL211-0724-0-05	37	FDC-37PF(05)	69.32	55.47	63.5	56.14	57.9	57.71	5.87	1.4	24.47	3.2

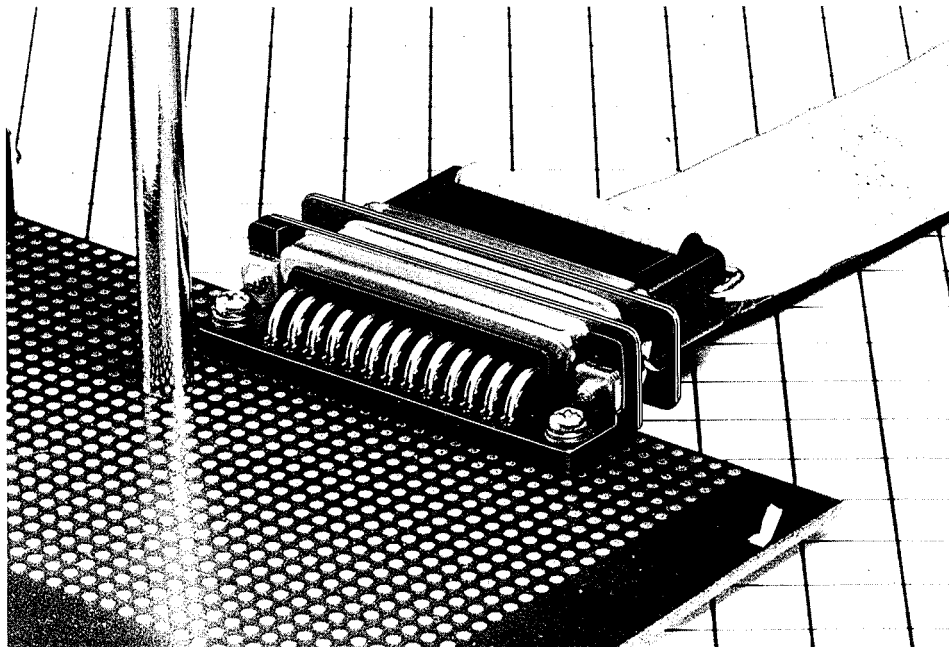

## Subminiature IDC Female

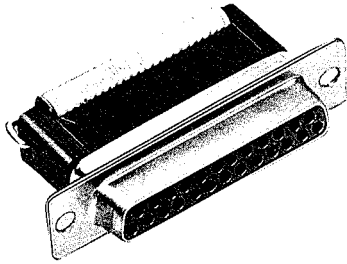

CL211-0136-2  
FDB-25S

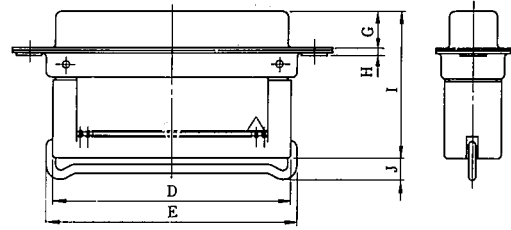
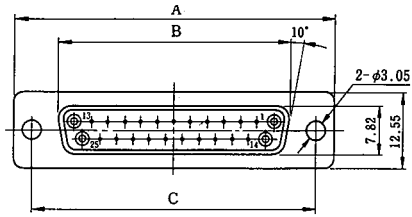

Unit: mm

HGS.No.	No. of pin	Part No.	A	B	C	D	E	F	G	H	I	J
CL211-0144-0	9	FDE-9S	30.81	16.4	24.99	17.6	19	19.28	6.17	1.2	24.37	2.7
CL211-0146-6	15	FDA-15S	39.14	24.59	33.32	25.8	27.2	27.55	6.17	1.2	24.37	2.7
CL211-0136-2	25	FDB-25S	53.04	38.3	47.04	39.6	41.4	41.28	6.17	1.2	24.37	3.2
CL211-0148-1	37	FDC-37S	69.32	54.76	63.5	56.14	57.9	57.71	6.17	1.2	24.37	3.2

Nickel-plated shells have (05) added to the part numbers.

## Connector Mounting Method and Mounting Dimensions

### ▶ Connector mounted on the face of the panel (front mounting)

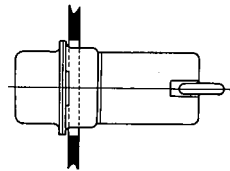
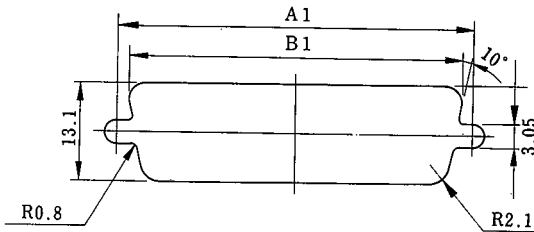

Unit: mm

Shell size	A1	B1
E	24.99	22
A	33.32	30.3
B	47.04	44
C	63.5	60.5

### ▶ Connector mounted on the back of the panel (rear mounting)

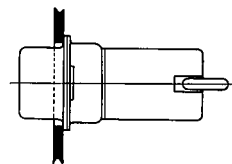
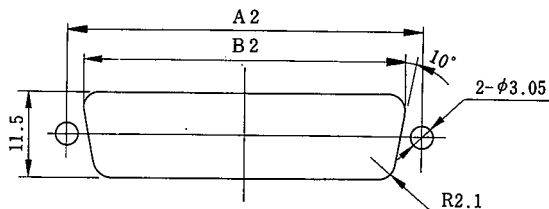

Rear Mounting

Unit: mm

Shell size	A2	B2
E	24.99	20.2
A	33.32	28.6
B	47.04	42.5
C	63.5	59.2

# Cabling Variations

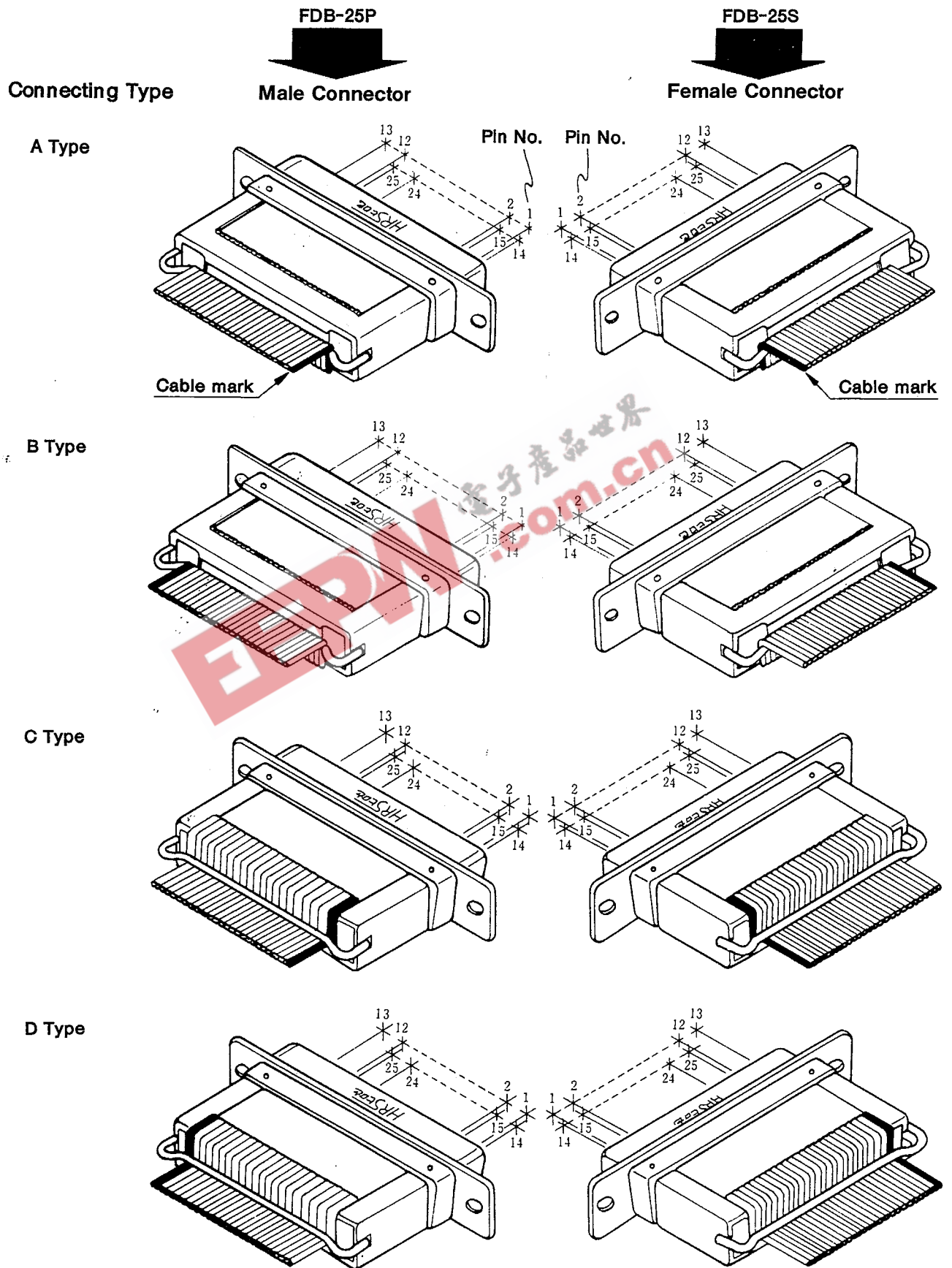

## Tools

### Hi-Flex Connecting Press

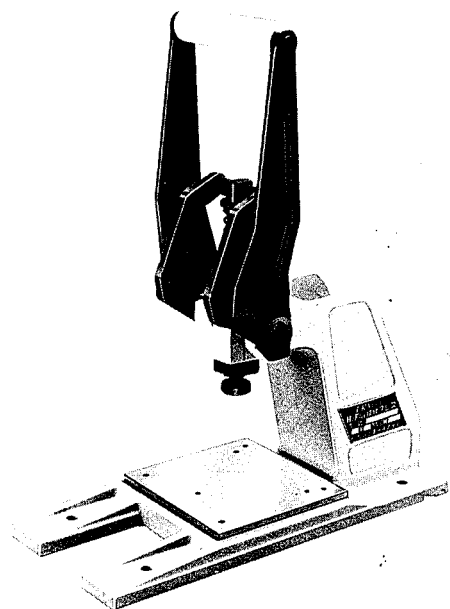

HRS No.	Part No.	Height	Width	Depth	Weight
550-0082-2	Hi-Flex connecting press	440mm	160mm	350mm	13kg

### Guide Plate

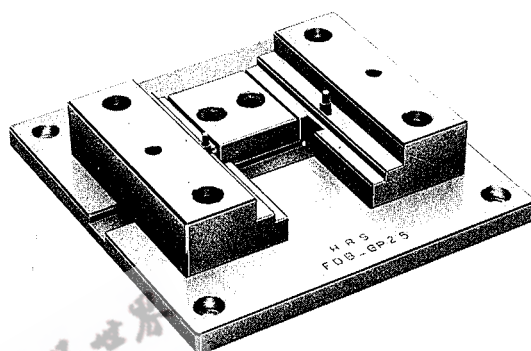

HRS No.	Part No.
902-0008-9	FDE-GP
902-0011-3	FDA-GP
902-0005-0	FDB-GP
902-0014-1	FDC-GP

### Pressure Block (For Plug)

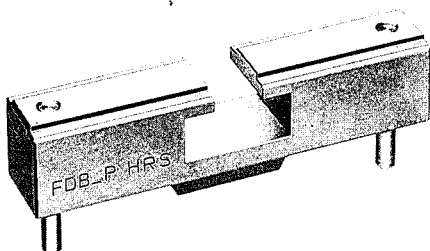

HRS No.	Part No.
902-0006-3	FDE-P pressure block
902-0009-1	FDA-P pressure block
902-0003-5	FDB-P pressure block
902-0012-6	FDC-P pressure block

### Pressure Block (For Socket)

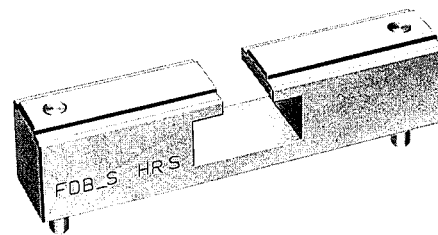

HRS No.	Part No.
902-0007-6	FDE-S pressure block
902-0010-0	FDA-S pressure block
902-0004-8	FDB-S pressure block
902-0013-9	FDC-S pressure block