

Type FCN Surface Mount Film Capacitors

Stable Stacked Metallized Film (PEN) Chips for Reflow Soldering

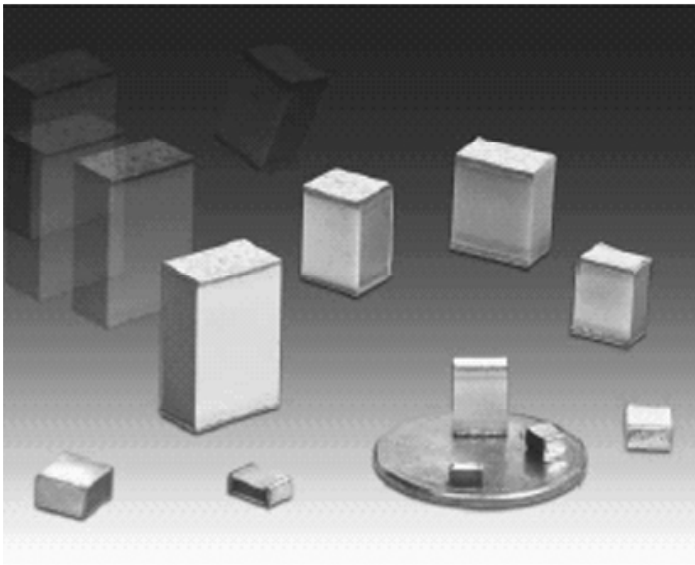

Type FCN SMT capacitors are the general purpose line of CDE's surface mount product offerings. They range in capacitance from .001 μF to 1.0 μF , and they are available in voltage ratings up to 400 Vdc.

Type FCN capacitors are designed for applications requiring a general purpose SMT capacitor with stable temperature and frequency characteristics similar to polyester film capacitors. They are ideal for applications such as EMI noise filtering, power supply input/output filters, audio or signal coupling, and IC power bus bypassing or decoupling. FCN SMT capacitors have a non-inductive stacked metallized PEN film construction which results in a low ESR and excellent high frequency performance.

Highlights

- Designed for reflow soldering
- Withstands 150% of rated voltage for 60 seconds
- Stacked metallized polyethylene naphthalate (PEN) film
- Performs like polyester capacitors
- Nonmagnetic and lead-free

Specifications

Capacitance Range:	1000 pF to 1.0 μF (1 kHz at 5 Vrms)
Capacitance Tolerance:	$\pm 5\%$ (J), $\pm 10\%$ (K) (See Ratings)
Voltages:	16, 50, 100, 250 & 400 Vdc
Operating Temperature Range:	16, 50, 100Vdc (<0.012 μF); -55 °C to +105 °C 100 Vdc ($\geq 0.012 \mu\text{F}$), 250, 400 Vdc; -40 °C to +85 °C
IR (at 20 °C, after 60 seconds):	C >0.33 μF : IR = 1000 M Ω · μF Min. C \leq 0.33 μF : IR \geq 3000 M Ω
Dissipation Factor (Tanδ):	1.0% Max. (1 kHz at 5 Vrms)
Life Test:	1000 h at rated temp. & 125% rated voltage Δ Capacitance: +1%, -6% max Dissipation Factor: 1.1% max IR: 1000 M Ω min (C>0.33 μF , 300 M Ω · μF min) No significant visual damage
Moisture Resistance:	1000 h at 40 °C and 90 - 95% RH & rated voltage Δ Capacitance: +8/-5% Dissipation Factor: 1.5% max IR: 100 M Ω min (C >0.33 μF , 30 M Ω · μF min) Voltage withstanding: 1.3 times rated voltage, 1 min. No significant damage



Complies with the EU Directive 2002/95/EC requirement restricting the use of Lead (Pb), Mercury (Hg), Cadmium (Cd), Hexavalent chromium (Cr(VI)), PolyBrominated Biphenyls (PBB) and PolyBrominated Diphenyl Ethers (PBDE).

Type FCN Surface Mount Film Capacitors

Specifications

Moisture Resistance:

500 h at 85 °C and 85% RH
 Δ Capacitance: ±10% max
 Dissipation Factor: 2% max
 IR: 10 MΩ min (C >0.33 μF, 3 MΩ•μF min)
 Voltage withstanding: 1.3 times rated voltage,
 1 min.
 No significant damage

Resistance to Soldering Heat:

5 s at max capacitor surface temperature
 Δ Capacitance: ±5% max
 Dissipation Factor: 1.1% max
 IR: 1000 MΩ min (C >0.33 μF, 300 MΩ•μF
 min)
 Voltage withstanding: 1.5 times rated voltage,
 1 min.
 No significant visual damage.

Withstand Voltage:

16 V & 50 V, 100 V ≤ 0.01 μF: 175% rated
 voltage, 5 s
 100 V ≥ 0.012 μF, 250 V and 400 V: 150% rated
 voltage, 5 s

Surface Temperature:

16 V & 50 V & 100 V ≤ 0.01 μF: 240 °C max
 100 V ≥ 0.012 μF, 250 V & 400 V: 230 °C max

Part Numbering System

Type	Case Size	Voltage	Capacitance	Tolerance	Code	Tape Width (mm)	Tape Diameter [in.(mm)]	Reel Quantity
FCN	1206	C = 16 Vdc	102 = 0.001 μF	J = ±5%	K1	= 8	7 (178)	4000
	1913	H = 50 Vdc	223 = 0.022 μF	K = ±10%	J1, J2	= 8	7 (178)	3000
	2416	A = 100 Vdc	474 = 0.47 μF		H1, H2	= 8	7 (178)	3000
	2420	E = 250 Vdc			H3	= 8	7 (178)	2000
	2820	G = 400 Vdc			G1, G2, G3	= 8	7 (178)	2000
	3022				E1, E2	= 12	13 (330)	3000
	3925				E3, E4	= 12	13 (330)	2000
	3931				D1, D2	= 12	13 (330)	3000
	6031				D3, D4, D5	= 12	13 (330)	2000
	6040				B, Z	= 12	13 (330)	1500
					U, V, X, Y	= 16	13 (330)	1000
					S, T	= 24	13 (330)	750

Type FCN Surface Mount Film Capacitors

Outline Drawing

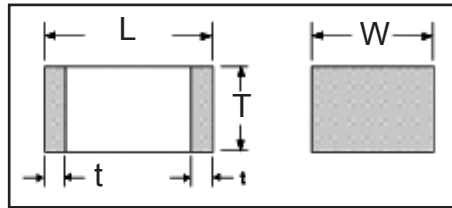

$t = 0.014 \pm 0.008$ in. (0.35 ± 0.2 mm)

For $0.001 \mu\text{F} - 0.01 \mu\text{F}$, 100 V, $t = 0.026 \pm 0.012$ in. (0.62 ± 0.3 mm)

Ratings

Cap (μF)	Catalog Part Number	L in (mm)	W in (mm)	T in (mm)
16 Vdc				
.12	FCN1913C124J-E1	0.189±0.008 (4.8±0.2)	0.130±0.012 (3.3±0.3)	0.055±0.008 (1.4±0.2)
.15	FCN1913C154J-E2	0.189±0.008 (4.8±0.2)	0.130±0.012 (3.3±0.3)	0.079±0.008 (2.0±0.2)
.18	FCN1913C184J-E2	0.189±0.008 (4.8±0.2)	0.130±0.012 (3.3±0.3)	0.079±0.008 (2.0±0.2)
.22	FCN1913C224J-E4	0.189±0.008 (4.8±0.2)	0.130±0.012 (3.3±0.3)	0.094±0.008 (2.4±0.2)
.27	FCN2416C274J-D1	0.236±0.008 (6.0±0.2)	0.161±0.012 (4.1±0.3)	0.071±0.008 (1.8±0.2)
.33	FCN2416C334J-D2	0.236±0.008 (6.0±0.2)	0.161±0.012 (4.1±0.3)	0.079±0.008 (2.0±0.2)
.39	FCN2416C394J-D3	0.236±0.008 (6.0±0.2)	0.161±0.012 (4.1±0.3)	0.094±0.008 (2.4±0.2)
.47	FCN2416C474J-D4	0.236±0.008 (6.0±0.2)	0.161±0.012 (4.1±0.3)	0.110±0.008 (2.8±0.2)
50 Vdc				
.056	FCN1913H563J-E2	0.189±0.008 (4.8±0.3)	0.130±0.012 (3.3±0.3)	0.055±0.008 (1.4±0.2)
.068	FCN1913H683J-E2	0.189±0.008 (4.8±0.3)	0.130±0.012 (3.3±0.3)	0.079±0.008 (2.0±0.2)
.082	FCN1913H823J-E4	0.189±0.008 (4.8±0.3)	0.130±0.012 (3.3±0.3)	0.079±0.008 (2.0±0.2)
.10	FCN1913H104J-E3	0.189±0.008 (4.8±0.3)	0.130±0.012 (3.3±0.3)	0.094±0.008 (2.4±0.2)
.12	FCN2416H124J-D1	0.236±0.008 (6.0±0.2)	0.161±0.012 (4.1±0.3)	0.071±0.008 (1.8±0.2)
.15	FCN2416H154J-D2	0.236±0.008 (6.0±0.2)	0.161±0.012 (4.1±0.3)	0.079±0.008 (2.0±0.2)
.18	FCN2416H184J-D3	0.236±0.008 (6.0±0.2)	0.161±0.012 (4.1±0.3)	0.094±0.008 (2.4±0.2)
.22	FCN2416H224J-D4	0.236±0.008 (6.0±0.2)	0.161±0.012 (4.1±0.3)	0.110±0.008 (2.8±0.2)
100 Vdc				
.0010	FCN1206A102J-H2	0.126±0.008 (3.2±0.2)	0.063±0.012 (1.6±0.3)	0.043±0.008 (1.1±0.2)
.0012	FCN1206A122J-H2	0.126±0.008 (3.2±0.2)	0.063±0.012 (1.6±0.3)	0.043±0.008 (1.1±0.2)
.0015	FCN1206A152J-H2	0.126±0.008 (3.2±0.2)	0.063±0.012 (1.6±0.3)	0.043±0.008 (1.1±0.2)
.0018	FCN1206A182J-H2	0.126±0.008 (3.2±0.2)	0.063±0.012 (1.6±0.3)	0.043±0.008 (1.1±0.2)
.0022	FCN1206A222J-H2	0.126±0.008 (3.2±0.2)	0.063±0.012 (1.6±0.3)	0.043±0.008 (1.1±0.2)
.0027	FCN1206A272J-H2	0.126±0.008 (3.2±0.2)	0.063±0.012 (1.6±0.3)	0.043±0.008 (1.1±0.2)
.0033	FCN1206A332J-H3	0.126±0.008 (3.2±0.2)	0.063±0.012 (1.6±0.3)	0.059±0.008 (1.5±0.2)
.0039	FCN1206A392J-H3	0.126±0.008 (3.2±0.2)	0.063±0.012 (1.6±0.3)	0.059±0.008 (1.5±0.2)
.0047	FCN1206A472J-H3	0.126±0.008 (3.2±0.2)	0.063±0.012 (1.6±0.3)	0.059±0.008 (1.5±0.2)
.0056	FCN1210A562J-G2	0.126±0.008 (3.2±0.2)	0.063±0.012 (1.6±0.3)	0.059±0.008 (1.5±0.2)
.0068	FCN1210A682J-G2	0.126±0.008 (3.2±0.2)	0.063±0.012 (1.6±0.3)	0.059±0.008 (1.5±0.2)
.0082	FCN1210A822J-G3	0.126±0.008 (3.2±0.2)	0.063±0.012 (1.6±0.3)	0.083±0.008 (2.1±0.2)
.010	FCN1210A103J-G3	0.126±0.008 (3.2±0.2)	0.063±0.012 (1.6±0.3)	0.083±0.008 (2.1±0.2)
.012	FCN1913A123K-E1	0.189±0.008 (4.8±0.2)	0.189±0.008 (3.3±0.3)	0.055±0.008 (1.4±0.2)
.015	FCN1913A153K-E1	0.189±0.008 (4.8±0.2)	0.189±0.008 (3.3±0.3)	0.055±0.008 (1.4±0.2)
.018	FCN1913A183K-E1	0.189±0.008 (4.8±0.2)	0.189±0.008 (3.3±0.3)	0.055±0.008 (1.4±0.2)
.022	FCN1913A223K-E1	0.189±0.008 (4.8±0.2)	0.189±0.008 (3.3±0.3)	0.055±0.008 (1.4±0.2)
.027	FCN1913A273K-E1	0.189±0.008 (4.8±0.2)	0.189±0.008 (3.3±0.3)	0.055±0.008 (1.4±0.2)
.033	FCN1913A333K-E1	0.189±0.008 (4.8±0.2)	0.189±0.008 (3.3±0.3)	0.055±0.008 (1.4±0.2)
.039	FCN1913A393K-E1	0.189±0.008 (4.8±0.2)	0.189±0.008 (3.3±0.3)	0.055±0.008 (1.4±0.2)

Type FCN Surface Mount Film Capacitors

Cap (μ F)	Catalog Part Number	L in (mm)	W in (mm)	T in (mm)
100 Vdc				
.047	FCN1913A473K-E2	0.189 \pm 0.008 (4.8 \pm 0.2)	0.189 \pm 0.008 (3.3 \pm 0.3)	0.079 \pm 0.008 (2.0 \pm 0.2)
.056	FCN1913A563K-E2	0.189 \pm 0.008 (4.8 \pm 0.2)	0.189 \pm 0.008 (3.3 \pm 0.3)	0.079 \pm 0.008 (2.0 \pm 0.2)
.068	FCN1913A683K-E4	0.189 \pm 0.008 (4.8 \pm 0.2)	0.189 \pm 0.008 (3.3 \pm 0.3)	0.094 \pm 0.008 (2.4 \pm 0.2)
.082	FCN1913A823K-E3	0.189 \pm 0.008 (4.8 \pm 0.2)	0.189 \pm 0.008 (3.3 \pm 0.3)	0.110 \pm 0.012 (2.8 \pm 0.3)
.10	FCN2416A104K-D1	0.189 \pm 0.008 (4.8 \pm 0.2)	0.236 \pm 0.008 (6.0 \pm 0.2)	0.071 \pm 0.012 (1.8 \pm 0.3)
.12	FCN2416A124K-D3*	0.189 \pm 0.008 (4.8 \pm 0.2)	0.236 \pm 0.008 (6.0 \pm 0.2)	0.099 \pm 0.012 (2.4 \pm 0.3)
.15	FCN2416A154K-D4*	0.189 \pm 0.008 (4.8 \pm 0.2)	0.236 \pm 0.008 (6.0 \pm 0.2)	0.110 \pm 0.012 (2.8 \pm 0.3)
.18	FCN2820A184K-Z	0.280 \pm 0.016 (7.1 \pm 0.4)	0.197 \pm 0.016 (5.0 \pm 0.4)	0.079 \pm 0.012 (2.0 \pm 0.3)
.22	FCN2820A224K-Z	0.280 \pm 0.016 (7.1 \pm 0.4)	0.197 \pm 0.016 (5.0 \pm 0.4)	0.094 \pm 0.012 (2.4 \pm 0.3)
.27	FCN2820A274K-Z	0.280 \pm 0.016 (7.1 \pm 0.4)	0.197 \pm 0.016 (5.0 \pm 0.4)	0.114 \pm 0.012 (2.9 \pm 0.3)
.33	FCN2820A334K-Z	0.280 \pm 0.016 (7.1 \pm 0.4)	0.197 \pm 0.016 (5.0 \pm 0.4)	0.138 \pm 0.012 (3.5 \pm 0.3)
.39	FCN3022A394K-X	0.303 \pm 0.016 (7.7 \pm 0.4)	0.217 \pm 0.016 (5.5 \pm 0.4)	0.134 \pm 0.012 (3.4 \pm 0.3)
.47	FCN3022A474K-X	0.303 \pm 0.016 (7.7 \pm 0.4)	0.217 \pm 0.016 (5.5 \pm 0.4)	0.157 \pm 0.012 (4.0 \pm 0.3)
.56	FCN3925A564K-V	0.386 \pm 0.016 (9.8 \pm 0.4)	0.248 \pm 0.016 (6.3 \pm 0.4)	0.118 \pm 0.012 (3.0 \pm 0.3)
.68	FCN3925A684K-V	0.386 \pm 0.016 (9.8 \pm 0.4)	0.248 \pm 0.016 (6.3 \pm 0.4)	0.142 \pm 0.012 (3.6 \pm 0.3)
.82	FCN3925A824K-V	0.386 \pm 0.016 (9.8 \pm 0.4)	0.248 \pm 0.016 (6.3 \pm 0.4)	0.169 \pm 0.012 (4.3 \pm 0.3)
1.0	FCN3925A105K-V	0.386 \pm 0.016 (9.8 \pm 0.4)	0.248 \pm 0.016 (6.3 \pm 0.4)	0.201 \pm 0.012 (5.1 \pm 0.3)
250 Vdc				
.0010	FCN1913E102K-E1*	0.189 \pm 0.008 (4.8 \pm 0.2)	0.130 \pm 0.012 (3.3 \pm 0.3)	0.055 \pm 0.008 (1.4 \pm 0.2)
.0012	FCN1913E122K-E1*	0.189 \pm 0.008 (4.8 \pm 0.2)	0.130 \pm 0.012 (3.3 \pm 0.3)	0.055 \pm 0.008 (1.4 \pm 0.2)
.0015	FCN1913E152K-E1*	0.189 \pm 0.008 (4.8 \pm 0.2)	0.130 \pm 0.012 (3.3 \pm 0.3)	0.055 \pm 0.008 (1.4 \pm 0.2)
.0018	FCN1913E182K-E1*	0.189 \pm 0.008 (4.8 \pm 0.2)	0.130 \pm 0.012 (3.3 \pm 0.3)	0.055 \pm 0.008 (1.4 \pm 0.2)
.0022	FCN1913E222K-E1*	0.189 \pm 0.008 (4.8 \pm 0.2)	0.130 \pm 0.012 (3.3 \pm 0.3)	0.055 \pm 0.008 (1.4 \pm 0.2)
.0027	FCN1913E272K-E1*	0.189 \pm 0.008 (4.8 \pm 0.2)	0.130 \pm 0.012 (3.3 \pm 0.3)	0.055 \pm 0.008 (1.4 \pm 0.2)
.0033	FCN1913E332K-E1*	0.189 \pm 0.008 (4.8 \pm 0.2)	0.130 \pm 0.012 (3.3 \pm 0.3)	0.055 \pm 0.008 (1.4 \pm 0.2)
.0039	FCN1913E392K-E1*	0.189 \pm 0.008 (4.8 \pm 0.2)	0.130 \pm 0.012 (3.3 \pm 0.3)	0.055 \pm 0.008 (1.4 \pm 0.2)
.0047	FCN1913E472K-E1*	0.189 \pm 0.008 (4.8 \pm 0.2)	0.130 \pm 0.012 (3.3 \pm 0.3)	0.055 \pm 0.008 (1.4 \pm 0.2)
.0056	FCN1913E562K-E1*	0.189 \pm 0.008 (4.8 \pm 0.2)	0.130 \pm 0.012 (3.3 \pm 0.3)	0.055 \pm 0.008 (1.4 \pm 0.2)
.0068	FCN1913E682K-E1*	0.189 \pm 0.008 (4.8 \pm 0.2)	0.130 \pm 0.012 (3.3 \pm 0.3)	0.055 \pm 0.008 (1.4 \pm 0.2)
.0082	FCN1913E822K-E1*	0.189 \pm 0.008 (4.8 \pm 0.2)	0.130 \pm 0.012 (3.3 \pm 0.3)	0.055 \pm 0.008 (1.4 \pm 0.2)
.010	FCN1913E103K-E1*	0.189 \pm 0.008 (4.8 \pm 0.2)	0.130 \pm 0.012 (3.3 \pm 0.3)	0.055 \pm 0.008 (1.4 \pm 0.2)
.012	FCN1913E123K-E1*	0.189 \pm 0.008 (4.8 \pm 0.2)	0.130 \pm 0.012 (3.3 \pm 0.3)	0.055 \pm 0.008 (1.4 \pm 0.2)
.015	FCN1913E153K-E1*	0.189 \pm 0.008 (4.8 \pm 0.2)	0.130 \pm 0.012 (3.3 \pm 0.3)	0.055 \pm 0.008 (1.4 \pm 0.2)
.018	FCN1913E183K-E2*	0.189 \pm 0.008 (4.8 \pm 0.2)	0.130 \pm 0.012 (3.3 \pm 0.3)	0.079 \pm 0.008 (2.0 \pm 0.2)
.022	FCN1913E223K-E2*	0.189 \pm 0.008 (4.8 \pm 0.2)	0.130 \pm 0.012 (3.3 \pm 0.3)	0.094 \pm 0.008 (2.4 \pm 0.2)
.027	FCN1913E273K-E4*	0.189 \pm 0.008 (4.8 \pm 0.2)	0.130 \pm 0.012 (3.3 \pm 0.3)	0.110 \pm 0.008 (2.8 \pm 0.2)
.033	FCN1913E333K-E3*	0.189 \pm 0.008 (4.8 \pm 0.2)	0.130 \pm 0.012 (3.3 \pm 0.3)	0.126 \pm 0.008 (3.2 \pm 0.2)
.039	FCN2416E393K-D2*	0.236 \pm 0.008 (6.0 \pm 0.2)	0.161 \pm 0.012 (4.1 \pm 0.3)	0.079 \pm 0.008 (2.0 \pm 0.2)
.047	FCN2416E473K-D3*	0.236 \pm 0.008 (6.0 \pm 0.2)	0.161 \pm 0.012 (4.1 \pm 0.3)	0.079 \pm 0.008 (2.0 \pm 0.2)
.056	FCN2416E563K-D4*	0.236 \pm 0.008 (6.0 \pm 0.2)	0.161 \pm 0.012 (4.1 \pm 0.3)	0.094 \pm 0.008 (2.4 \pm 0.2)
.068	FCN2416E683K-D5*	0.236 \pm 0.008 (6.0 \pm 0.2)	0.161 \pm 0.012 (4.1 \pm 0.3)	0.110 \pm 0.008 (2.8 \pm 0.2)
.082	FCN2420E823K-B*	0.236 \pm 0.008 (6.0 \pm 0.2)	0.197 \pm 0.016 (5.0 \pm 0.4)	0.126 \pm 0.012 (3.2 \pm 0.3)
.10	FCN2420E104K-B*	0.236 \pm 0.008 (6.0 \pm 0.2)	0.197 \pm 0.016 (5.0 \pm 0.4)	0.150 \pm 0.012 (3.8 \pm 0.3)
.12	FCN2420E124K-B*	0.236 \pm 0.008 (6.0 \pm 0.2)	0.197 \pm 0.016 (5.0 \pm 0.4)	0.177 \pm 0.012 (4.5 \pm 0.3)
.15	FCN2825E154K-Y	0.280 \pm 0.016 (7.1 \pm 0.4)	0.248 \pm 0.016 (6.3 \pm 0.4)	0.138 \pm 0.012 (3.5 \pm 0.3)
.18	FCN2825E184K-Y	0.280 \pm 0.016 (7.1 \pm 0.4)	0.248 \pm 0.016 (6.3 \pm 0.4)	0.161 \pm 0.012 (4.1 \pm 0.3)
.22	FCN2825E224K-Y	0.280 \pm 0.016 (7.1 \pm 0.4)	0.248 \pm 0.016 (6.3 \pm 0.4)	0.201 \pm 0.012 (5.1 \pm 0.3)
.27	FCN3925E274K-V	0.386 \pm 0.020 (9.8 \pm 0.5)	0.248 \pm 0.016 (6.3 \pm 0.4)	0.154 \pm 0.012 (3.9 \pm 0.3)

* also available in 5% (J) tolerance

Type FCN Surface Mount Film Capacitors

Cap (μ F)	Catalog Part Number	L in (mm)	W in (mm)	T in (mm)
250 Vdc				
.33	FCN3925E334K-V	0.386 \pm 0.020 (9.8 \pm 0.5)	0.248 \pm 0.016 (6.3 \pm 0.4)	0.189 \pm 0.012 (4.8 \pm 0.3)
.39	FCN3931E394K-U	0.386 \pm 0.020 (9.8 \pm 0.5)	0.315 \pm 0.016 (8.0 \pm 0.4)	0.173 \pm 0.012 (4.4 \pm 0.3)
.47	FCN3931E474K-U	0.386 \pm 0.020 (9.8 \pm 0.5)	0.315 \pm 0.016 (8.0 \pm 0.4)	0.209 \pm 0.012 (5.3 \pm 0.3)
.56	FCN6031E564K-T	0.598 \pm 0.020 (15.2 \pm 0.5)	0.315 \pm 0.016 (8.0 \pm 0.4)	0.146 \pm 0.012 (3.7 \pm 0.3)
.68	FCN6031E684K-T	0.598 \pm 0.020 (15.2 \pm 0.5)	0.315 \pm 0.016 (8.0 \pm 0.4)	0.173 \pm 0.012 (4.4 \pm 0.3)
.82	FCN6040E824K-S	0.598 \pm 0.020 (15.2 \pm 0.5)	0.394 \pm 0.016 (10.0 \pm 0.4)	0.165 \pm 0.012 (4.2 \pm 0.3)
1.0	FCN6040E105K-S	0.598 \pm 0.020 (15.2 \pm 0.5)	0.394 \pm 0.016 (10.0 \pm 0.4)	0.201 \pm 0.012 (5.1 \pm 0.3)
400 Vdc				
.0010	FCN1913G102J-E1	0.189 \pm 0.008 (4.8 \pm 0.2)	0.130 \pm 0.012 (3.3 \pm 0.3)	0.055 \pm 0.008 (1.4 \pm 0.2)
.0012	FCN1913G122J-E1	0.189 \pm 0.008 (4.8 \pm 0.2)	0.130 \pm 0.012 (3.3 \pm 0.3)	0.055 \pm 0.008 (1.4 \pm 0.2)
.0015	FCN1913G152J-E1	0.189 \pm 0.008 (4.8 \pm 0.2)	0.130 \pm 0.012 (3.3 \pm 0.3)	0.055 \pm 0.008 (1.4 \pm 0.2)
.0018	FCN1913G182J-E1	0.189 \pm 0.008 (4.8 \pm 0.2)	0.130 \pm 0.012 (3.3 \pm 0.3)	0.055 \pm 0.008 (1.4 \pm 0.2)
.0022	FCN1913G222J-E1	0.189 \pm 0.008 (4.8 \pm 0.2)	0.130 \pm 0.012 (3.3 \pm 0.3)	0.055 \pm 0.008 (1.4 \pm 0.2)
.0027	FCN1913G272J-E1	0.189 \pm 0.008 (4.8 \pm 0.2)	0.130 \pm 0.012 (3.3 \pm 0.3)	0.055 \pm 0.008 (1.4 \pm 0.2)
.0033	FCN1913G332J-E1	0.189 \pm 0.008 (4.8 \pm 0.2)	0.130 \pm 0.012 (3.3 \pm 0.3)	0.055 \pm 0.008 (1.4 \pm 0.2)
.0039	FCN1913G392J-E1	0.189 \pm 0.008 (4.8 \pm 0.2)	0.130 \pm 0.012 (3.3 \pm 0.3)	0.055 \pm 0.008 (1.4 \pm 0.2)
.0047	FCN1913G472J-E1	0.189 \pm 0.008 (4.8 \pm 0.2)	0.130 \pm 0.012 (3.3 \pm 0.3)	0.055 \pm 0.008 (1.4 \pm 0.2)
.0056	FCN1913G562J-E2	0.189 \pm 0.008 (4.8 \pm 0.2)	0.130 \pm 0.012 (3.3 \pm 0.3)	0.079 \pm 0.008 (2.0 \pm 0.2)
.0068	FCN1913G682J-E2	0.189 \pm 0.008 (4.8 \pm 0.2)	0.130 \pm 0.012 (3.3 \pm 0.3)	0.079 \pm 0.008 (2.0 \pm 0.2)
.0082	FCN1913G822J-E4	0.189 \pm 0.008 (4.8 \pm 0.2)	0.130 \pm 0.012 (3.3 \pm 0.3)	0.094 \pm 0.008 (2.4 \pm 0.2)
.010	FCN1913G103J-E3	0.189 \pm 0.008 (4.8 \pm 0.2)	0.130 \pm 0.012 (3.3 \pm 0.3)	0.110 \pm 0.008 (2.8 \pm 0.2)
.012	FCN2416G123J-D2	0.236 \pm 0.008 (6.0 \pm 0.2)	0.161 \pm 0.012 (4.1 \pm 0.3)	0.079 \pm 0.008 (2.0 \pm 0.2)
.015	FCN2416G153J-D3	0.236 \pm 0.008 (6.0 \pm 0.2)	0.161 \pm 0.012 (4.1 \pm 0.3)	0.079 \pm 0.008 (2.0 \pm 0.2)
.018	FCN2416G183J-D4	0.236 \pm 0.008 (6.0 \pm 0.2)	0.161 \pm 0.012 (4.1 \pm 0.3)	0.110 \pm 0.008 (2.8 \pm 0.2)
.022	FCN2416G223J-D5	0.236 \pm 0.008 (6.0 \pm 0.2)	0.161 \pm 0.012 (4.1 \pm 0.3)	0.126 \pm 0.012 (3.2 \pm 0.3)
.027	FCN2420G273J-B	0.236 \pm 0.008 (6.0 \pm 0.2)	0.197 \pm 0.016 (5.0 \pm 0.4)	0.118 \pm 0.012 (3.0 \pm 0.3)
.033	FCN2420G333J-B	0.236 \pm 0.008 (6.0 \pm 0.2)	0.197 \pm 0.016 (5.0 \pm 0.4)	0.142 \pm 0.012 (3.6 \pm 0.3)
.039	FCN2820G393J-Z	0.280 \pm 0.016 (7.1 \pm 0.4)	0.197 \pm 0.016 (5.0 \pm 0.4)	0.126 \pm 0.012 (3.2 \pm 0.3)
.047	FCN2820G473J-Z	0.280 \pm 0.016 (7.1 \pm 0.4)	0.197 \pm 0.016 (5.0 \pm 0.4)	0.150 \pm 0.012 (3.8 \pm 0.3)
.056	FCN2825G563J-Y	0.280 \pm 0.016 (7.1 \pm 0.4)	0.248 \pm 0.016 (6.3 \pm 0.4)	0.142 \pm 0.012 (3.6 \pm 0.3)
.068	FCN2825G683J-Y	0.280 \pm 0.016 (7.1 \pm 0.4)	0.248 \pm 0.016 (6.3 \pm 0.4)	0.173 \pm 0.012 (4.4 \pm 0.3)
.082	FCN3925G823J-V	0.386 \pm 0.016 (9.8 \pm 0.4)	0.248 \pm 0.016 (6.3 \pm 0.4)	0.134 \pm 0.012 (3.4 \pm 0.3)
.10	FCN3925G104J-V	0.386 \pm 0.016 (9.8 \pm 0.4)	0.248 \pm 0.016 (6.3 \pm 0.4)	0.157 \pm 0.012 (4.0 \pm 0.3)
.12	FCN3931G124J-U	0.386 \pm 0.016 (9.8 \pm 0.4)	0.315 \pm 0.016 (8.0 \pm 0.4)	0.150 \pm 0.012 (3.8 \pm 0.3)
.15	FCN3931G154J-U	0.386 \pm 0.016 (9.8 \pm 0.4)	0.315 \pm 0.016 (8.0 \pm 0.4)	0.181 \pm 0.012 (4.6 \pm 0.3)

Type FCN Surface Mount Film Capacitors

Typical Temperature Characteristics

Typical Frequency Characteristics

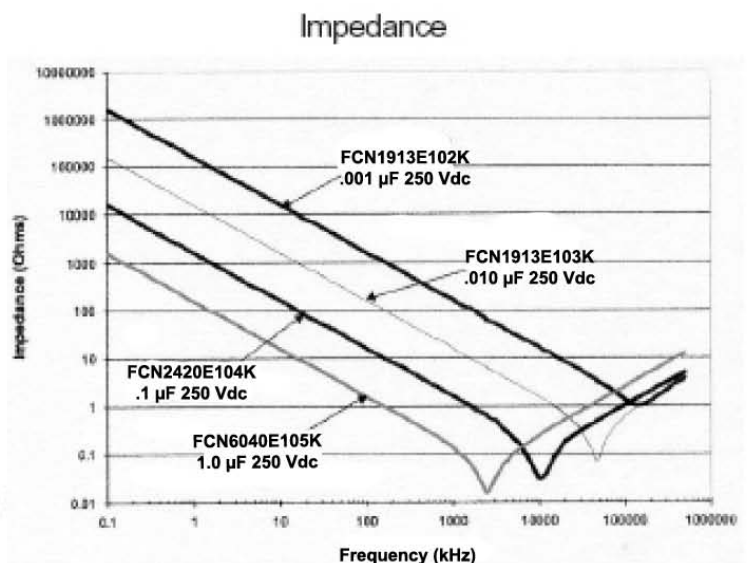
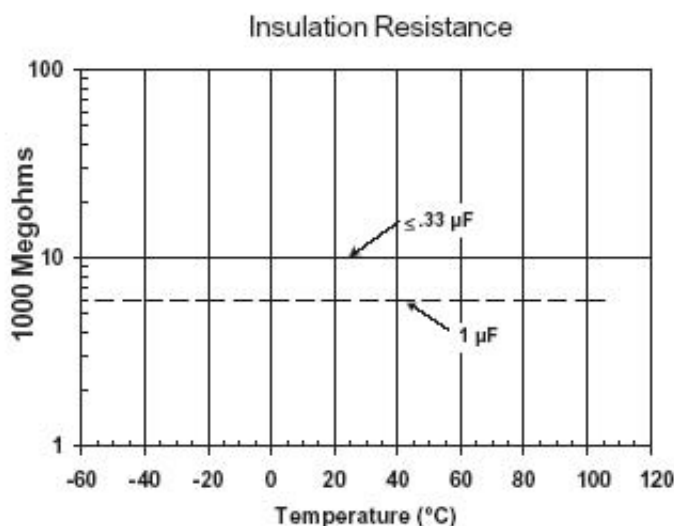
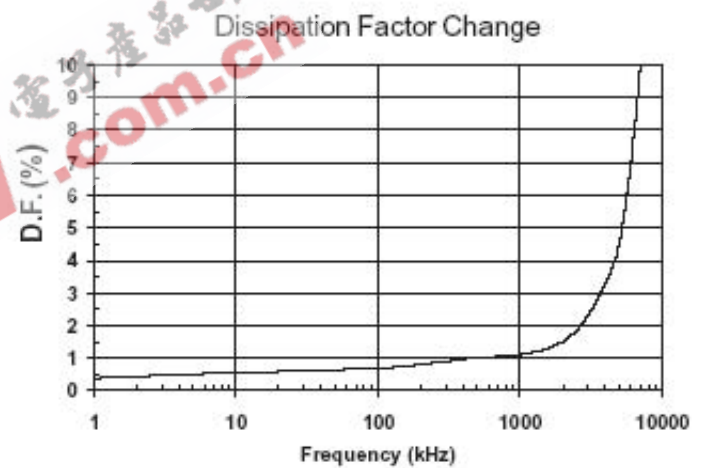
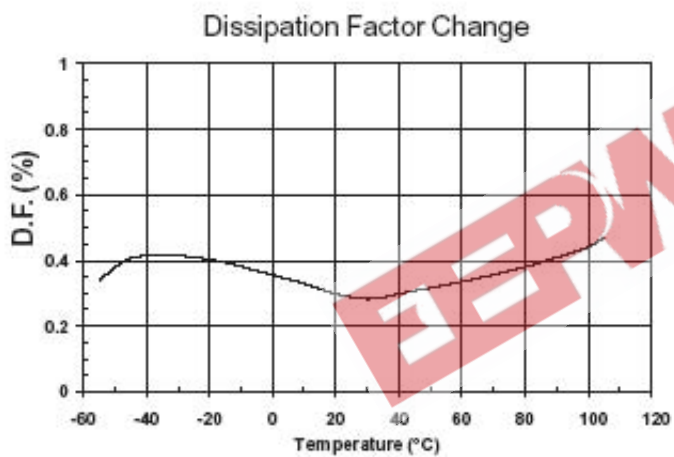
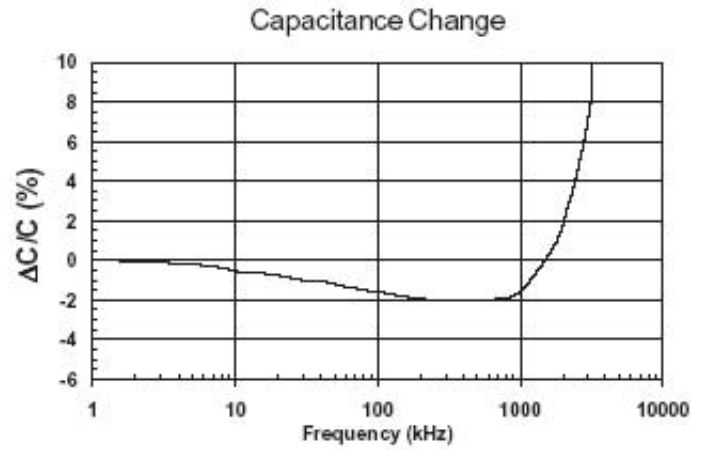
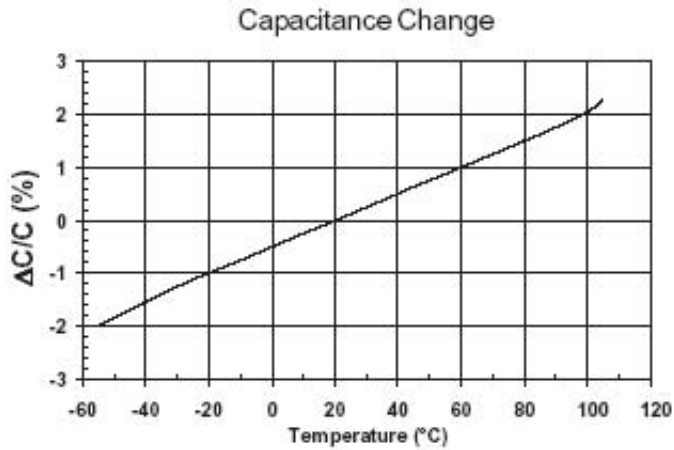

Type FCN Surface Mount Film Capacitors

Vrms vs. Frequency Characteristics

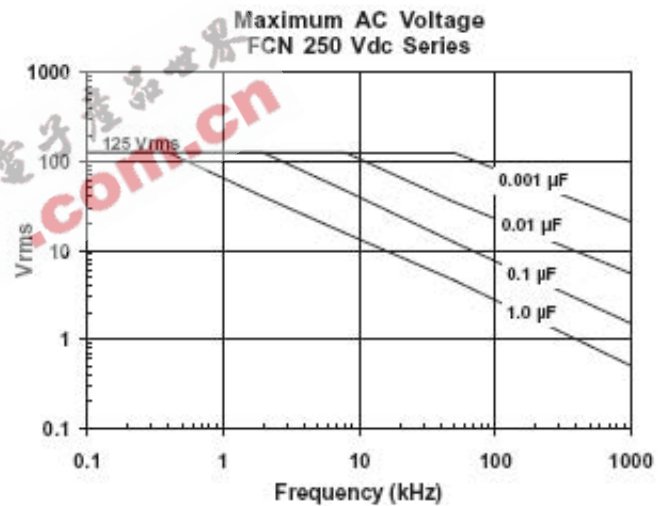
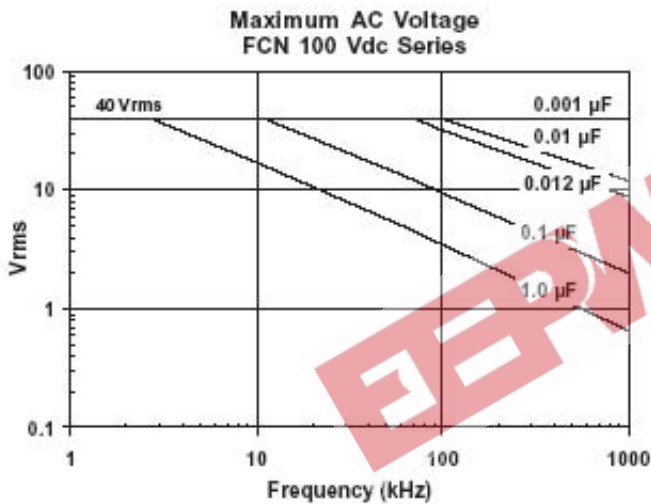
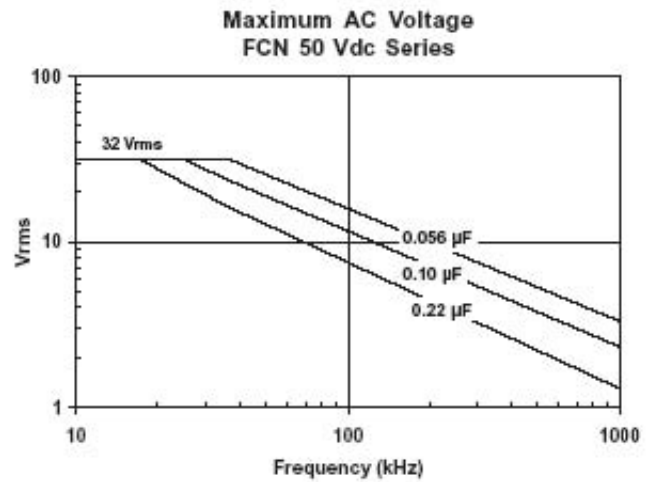
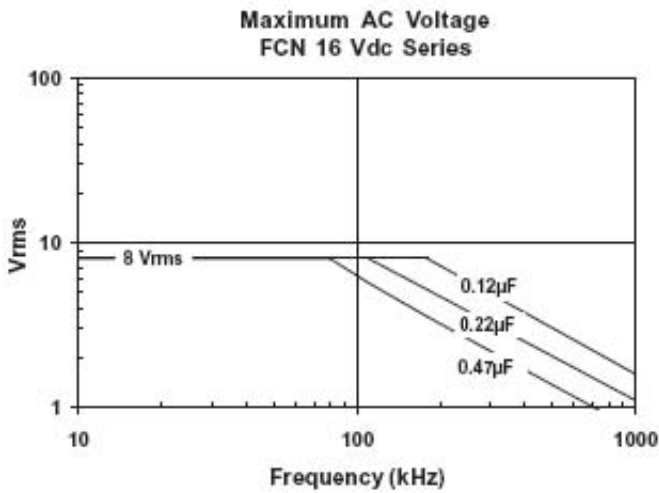

Voltage Derating vs Temperature

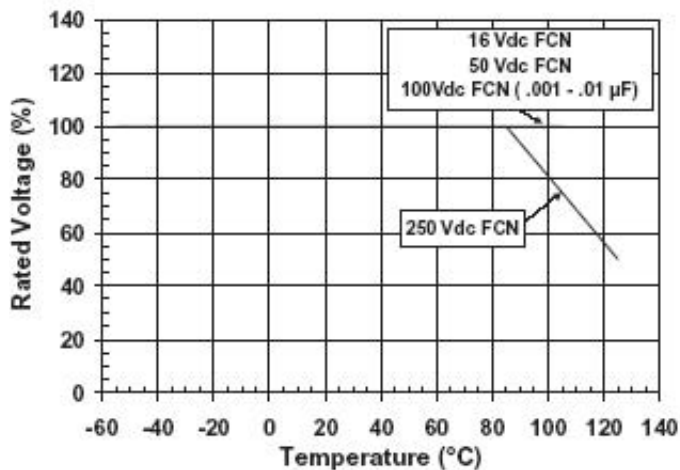

Maximum RMS Current vs Frequency 400 Vdc FCN

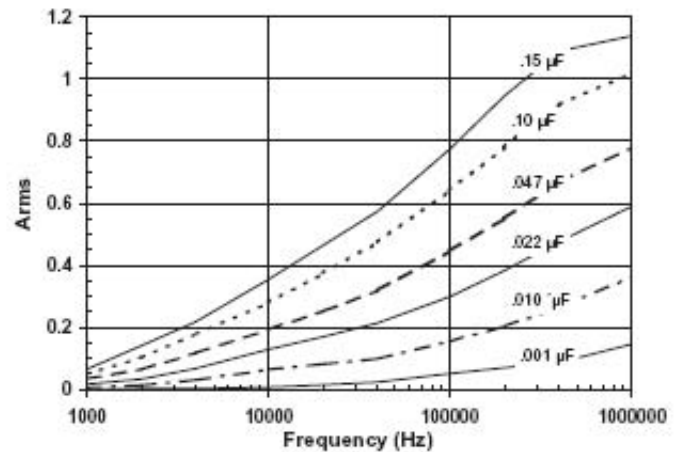

Type FCN Surface Mount Film Capacitors

Pulse Handling Capability

Capacitance (μF)	Voltage (Vdc)	dV/dt (volts/ μsec)	Capacitance (μF)	Voltage (Vdc)	dV/dt (volts/ μsec)	Capacitance (μF)	Voltage (Vdc)	dV/dt (volts/ μsec)
.12 - .22	16	60	.0039	100	530	.001 - .0039	250	615
.27 - .47	16	40	.0047	100	480	.0047 - .033	250	360
.056 - .10	50	190	.0056	100	450	.039 - .12	250	240
.12 - .22	50	130	.0068	100	410	.15 - .22	250	190
.001	100	1000	.0082	100	370	.27 - .47	250	115
.0012	100	920	.01	100	340	.56 - 1.0	250	65
.0015	100	830	.012 - .082	100	320	.001 - .0039	400	615
.0018	100	760	.10 - .15	100	210	.0047 - .01	400	360
.0022	100	690	.18 - .33	100	120	.012 - .033	400	240
.0027	100	630	.39 - .47	100	100	.039 - .068	400	190
.0033	100	570	.056 - 1.0	100	70	.082 - .15	400	115

Typical Applications

DC Blocking for xDSL

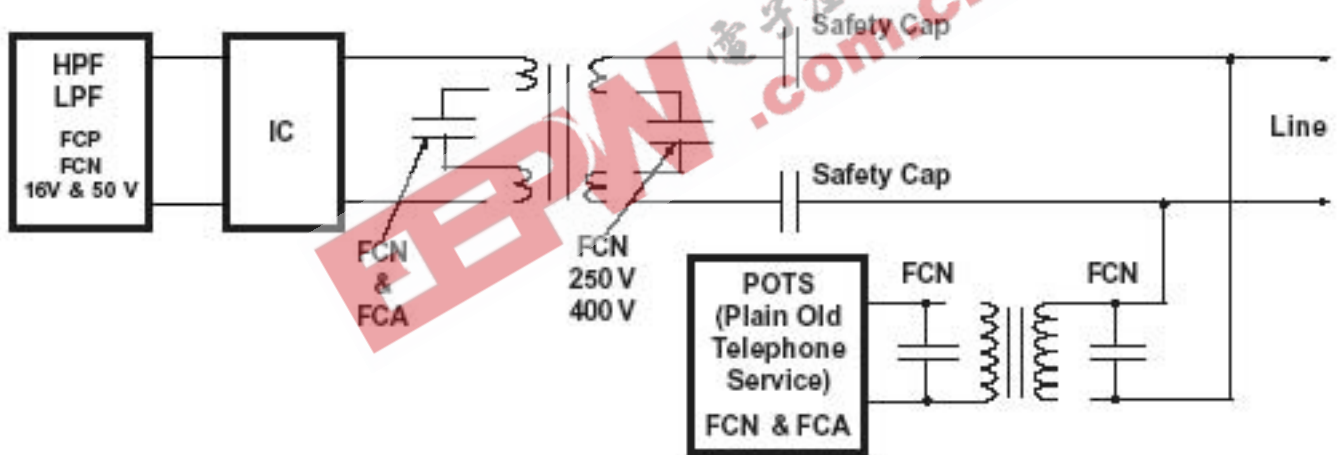

Integration for Electroluminescent (EL) Driver

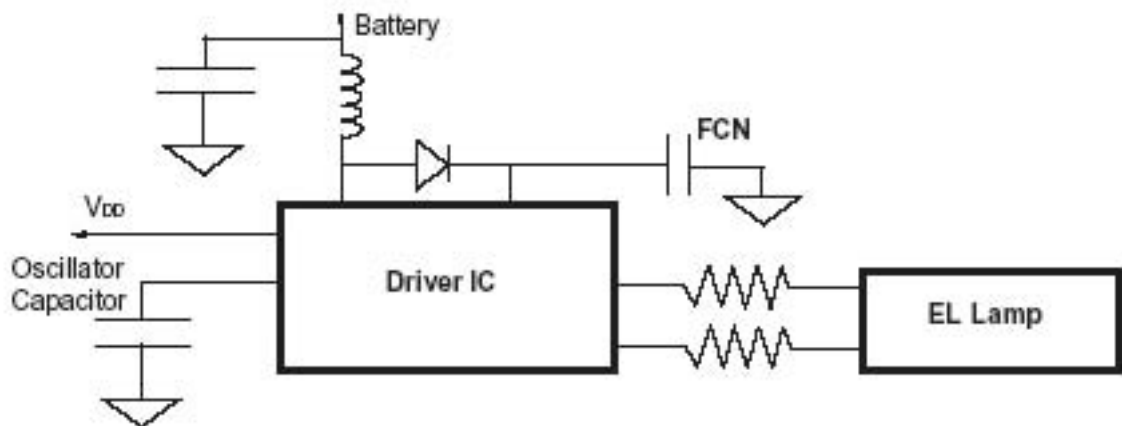

With no piezoelectric effects to deal with, the SMT film capacitor will not create electrical noise in signal circuits or buzzing in power circuits.