

FAN7021

CMOS Power Amplifier

Features

- Continuous Average Power is 1.0W (8Ω)
- Low THD: Under 0.2% (5V)
- Do not Need Output Coupling Capacitor or Bootstrap Capacitor
- Low Shutdown Current: 0.01μA
- Shutdown: High Active
- Built in Reduction Circuit for Popping noise
- Built in TSD Circuit

Typical Applications

- Cellular Phone
- Portable Computer
- Audio Systems

Description

The FAN7021 is a bridge connected audio power amplifier capable of delivering 1W of continuous average power to an 8Ω load with less than 0.2% (THD) from a 5V power supply. The FAN7021 require few external components and operate on low supply voltage from 2.0V to 5.5V. Since the FAN7021 does not require output coupling capacitor, bootstrap capacitors, or snubber networks, it is ideally suited for low power portable systems that require minimum volume and weight. The FAN7021 feqtures an externally controlled, low power consumption shutdown mode (0.01 uA,typ). Additional FAN7021 features include thermal shutdown protection, unity gain stability, and external gain set.

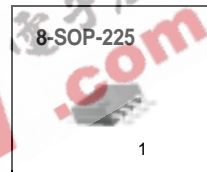

Internal Block Diagram

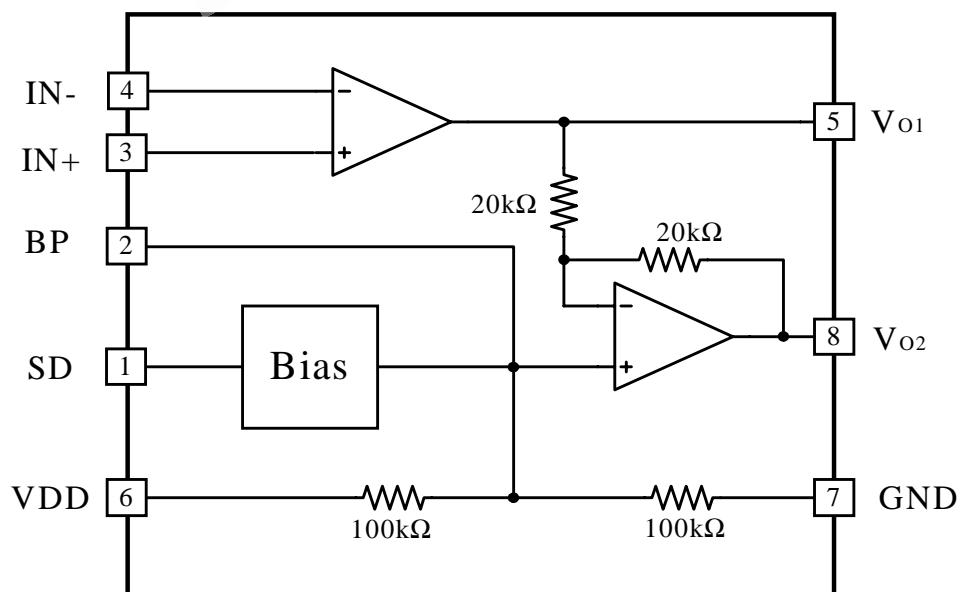

Pin Assignments

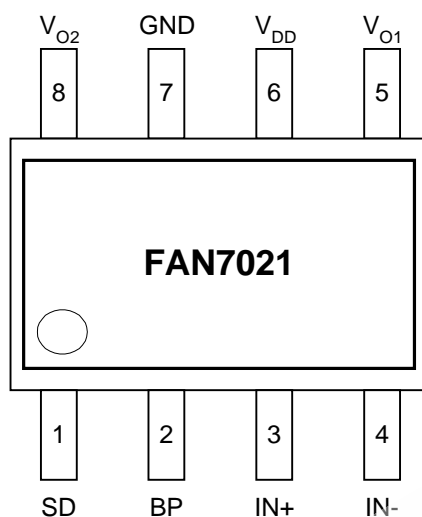

Pin Definitions

Pin Number	Pin Name	Pin Function Description
1	SD	Shutdown
2	BP	Bypass
3	IN+	Input +
4	IN-	Input -
5	VO1	Power AMP Output 1
6	VDD	Supply Voltage
7	GND	Ground
8	VO2	Power AMP Output 2

Absolute Maximum Ratings (Ta = 25°C)

Parameter	Symbol	Value	Unit	Remark
Maximum Supply Voltage	VDD	6.0	V	Maximum Supply Voltage
Power Dissipation	PD	-	W	-
Operating Temperature	TOPR	-40 ~ +85	°C	Operating Temperature
Storage Temperature	TSTG	-65 ~ +150	°C	Storage Temperature
Thermal Resistance	θ_{JA}	180	°C/W	Thermal Resistance

Recommended Operating Conditions (Ta = 25°C)

Parameter	Symbol	Min.	Typ.	Max.	Unit
Operating Supply Voltage	VDD	2.0	-	5.5	V

Electrical Characteristics

($R_L = 8\Omega$, $T_a = 25^\circ\text{C}$, Unless otherwise specified)

Parameter	Symbol	Conditions	Min.	Typ.	Max.	Unit
V_{DD} = 5.0V, UNLESS OTHERWISE SPECIFIED						
Quiescent Power Supply Current	I _{DD}	V _{IN} =0V, I _O =0A	-	4.0	7.0	mA
Shutdown Current	I _{SD}	V _{SD} =V _{DD}	-	0.01	2.0	μA
Output Offset Voltage	V _{OS}	V _{IN} =0V	-	5	50	mV
Output Power	P _O	THD=0.2% (Max.);f=1KHz	-	1	-	W
Total Harmonic Distortion+noise	THD+N	P _O =0.25W _{rms} ,A _{VD} =2				
		f=1KHz	-	0.1	-	%
		f=20KHz	-	0.4	-	%
Power Supply Rejection Ratio	PSRR	V _{DD} =4.9V to 5.1V	-	65	-	dB
V_{DD} = 3.3V, UNLESS OTHERWISE SPECIFIED						
Quiescent Power Supply Current	I _{DD}	V _{IN} =0V, I _O =0A	-	3.0	-	mA
Shutdown Current	I _{SD}	V _{SD} =V _{DD}	-	0.01	-	μA
Output Offset Voltage	V _{OS}	V _{IN} =0V	-	5	-	mV
Output Power	P _O	THD=1% (Max.);f=1KHz	-	0.5	-	W
Total Harmonic Distortion+noise	THD+N	P _O =0.25W _{rms} ,A _{VD} =2				
		f=1KHz	-	0.15	-	%
		f=20KHz	-	0.45	-	%
Power Supply Rejection Ratio	PSRR	V _{DD} =3.2V to 3.4V	-	65	-	dB
V_{DD} = 2.6V, UNLESS OTHERWISE SPECIFIED						
Quiescent Power Supply Current	I _{DD}	V _{IN} =0V, I _O =0A	-	2.5	-	mA
Shutdown Current	I _{SD}	V _{SD} =V _{DD}	-	0.01	-	μA
Output Offset Voltage	V _{OS}	V _{IN} =0V	-	5	-	mV
Output Power	P _O	THD=0.3% (Max.);f=1KHz	-	0.25	-	W
Total Harmonic Distortion+Noise	THD+N	P _O =0.25W _{rms} ,A _{VD} =2				
		f=1KHz	-	0.25	-	%
		f=20KHz	-	0.5	-	%
Power Supply Rejection Ratio	PSRR	V _{DD} =2.5V to 2.7V	-	65	-	dB

Typical Application Circuits

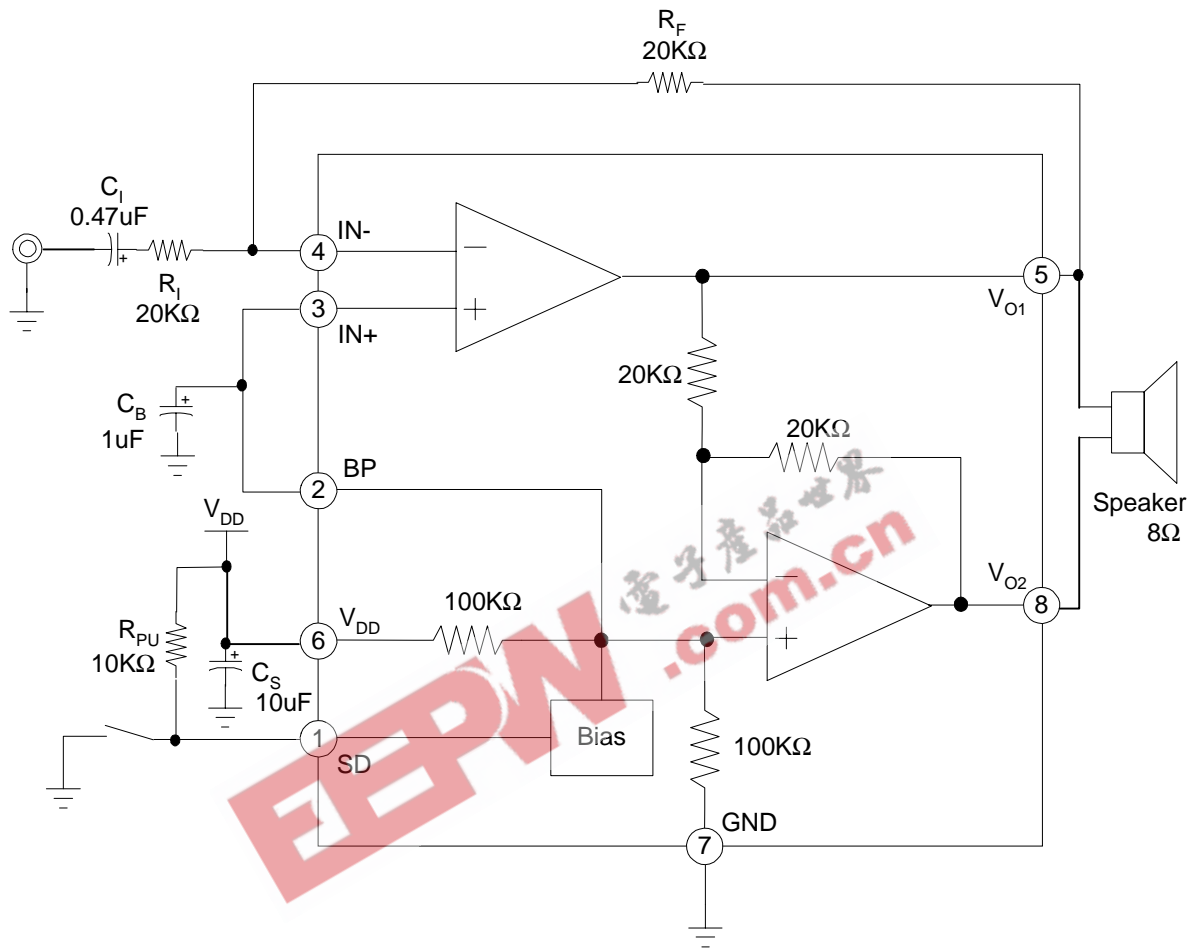

Performance Characteristics

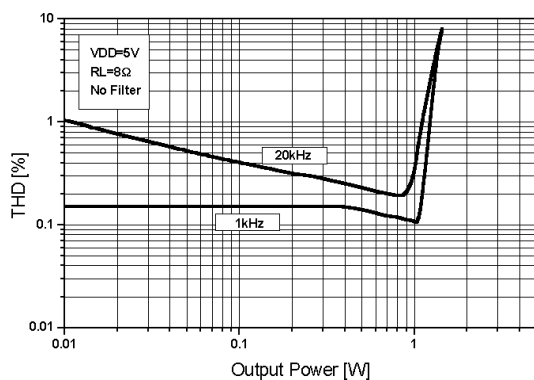

Figure 1. THD+N versus output power

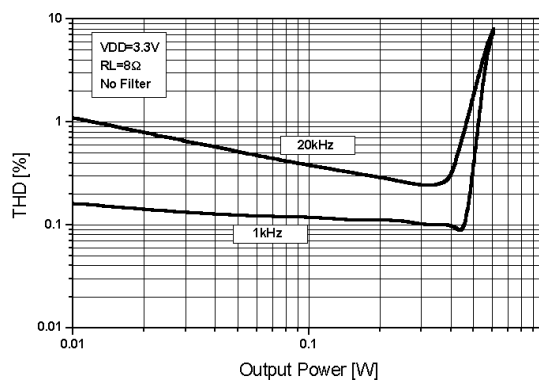

Figure 2. THD+N versus output power

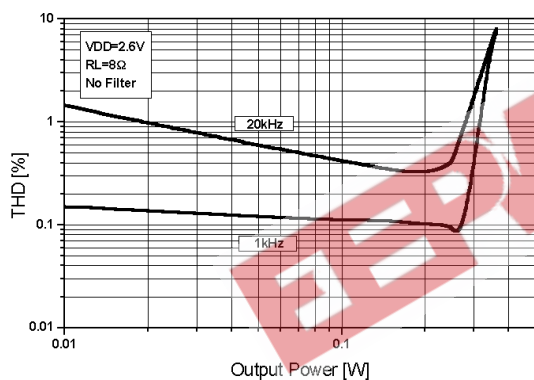

Figure 3. THD+N versus output power

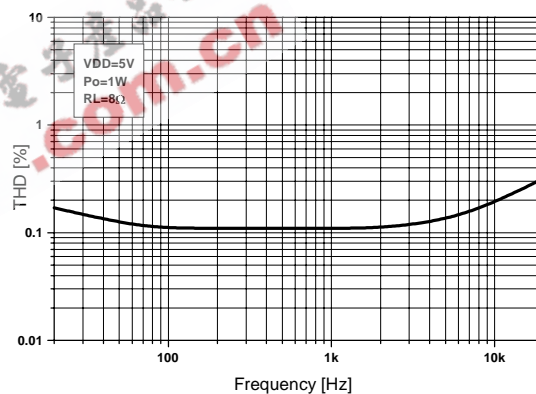

Figure 4. THD+N versus Frequency

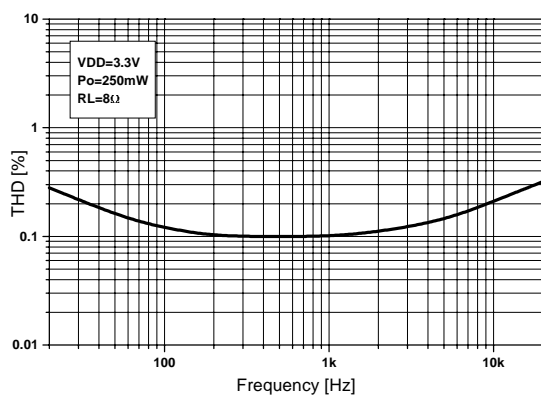

Figure 5. THD+N versus Frequency

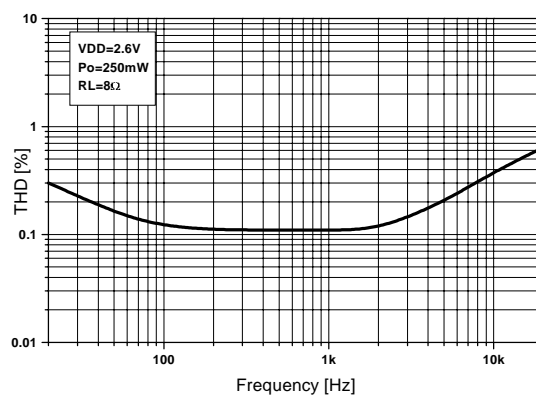

Figure 6. THD+N versus Frequency

Performance Characteristics (Continued)

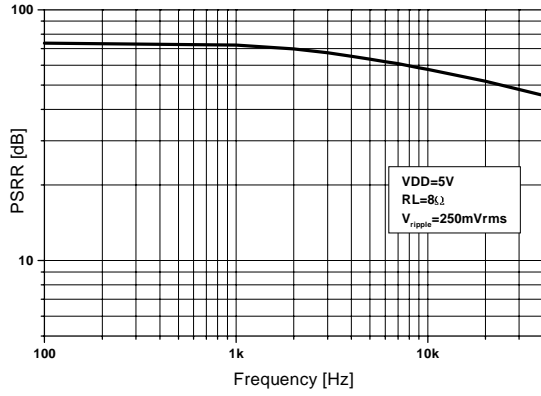

Figure 7. Power supply rejection ration

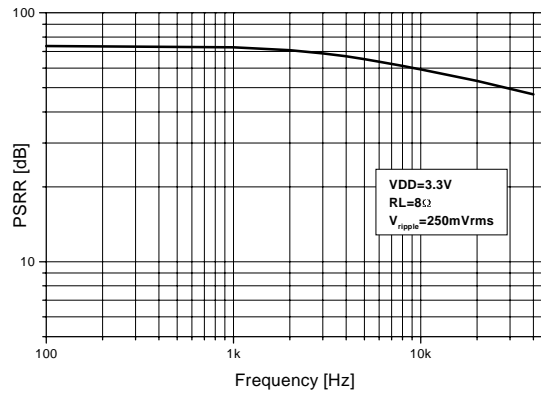

Figure 8. Power supply rejection ration

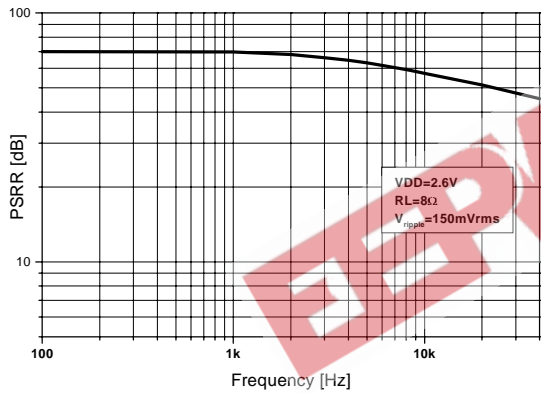

Figure 9. Power supply rejection ration

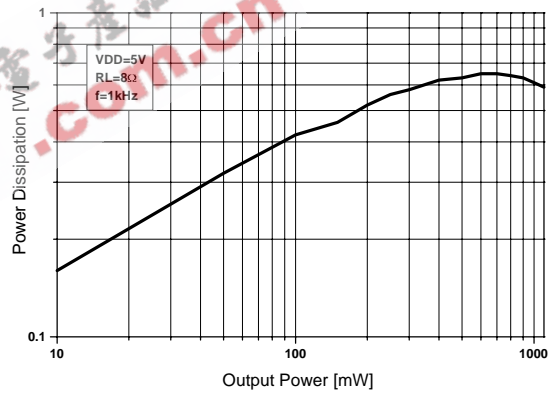

Figure 10. Power Dissipation versus output power

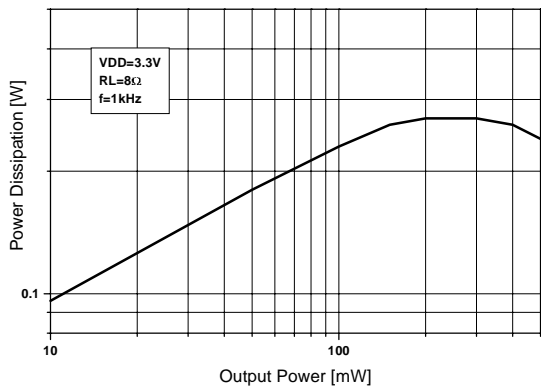

Figure 11. Power Dissipation versus output power

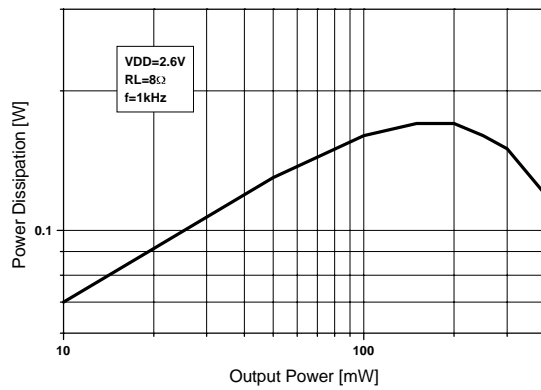

Figure 12. Power Dissipation versus output power

Performance Characteristics (Continued)

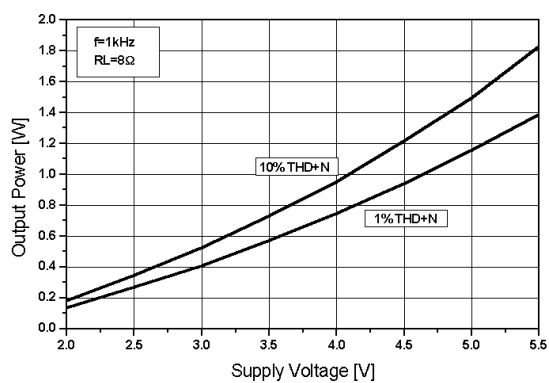

Figure 13. Output power versus supply voltage

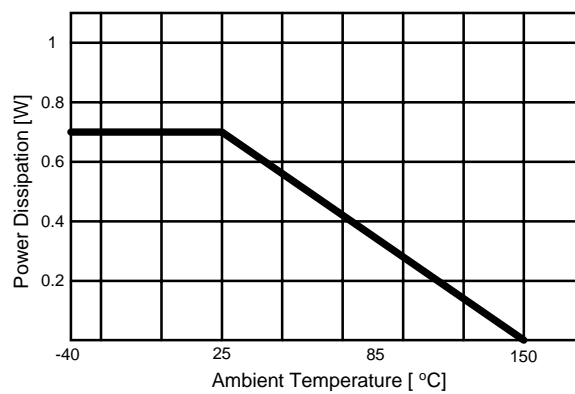

Figure 14. Power derating curve

EEPW 电子产品世界 .com.cn

Mechanical Dimensions (Unit: mm)

Package

8-SOP-225

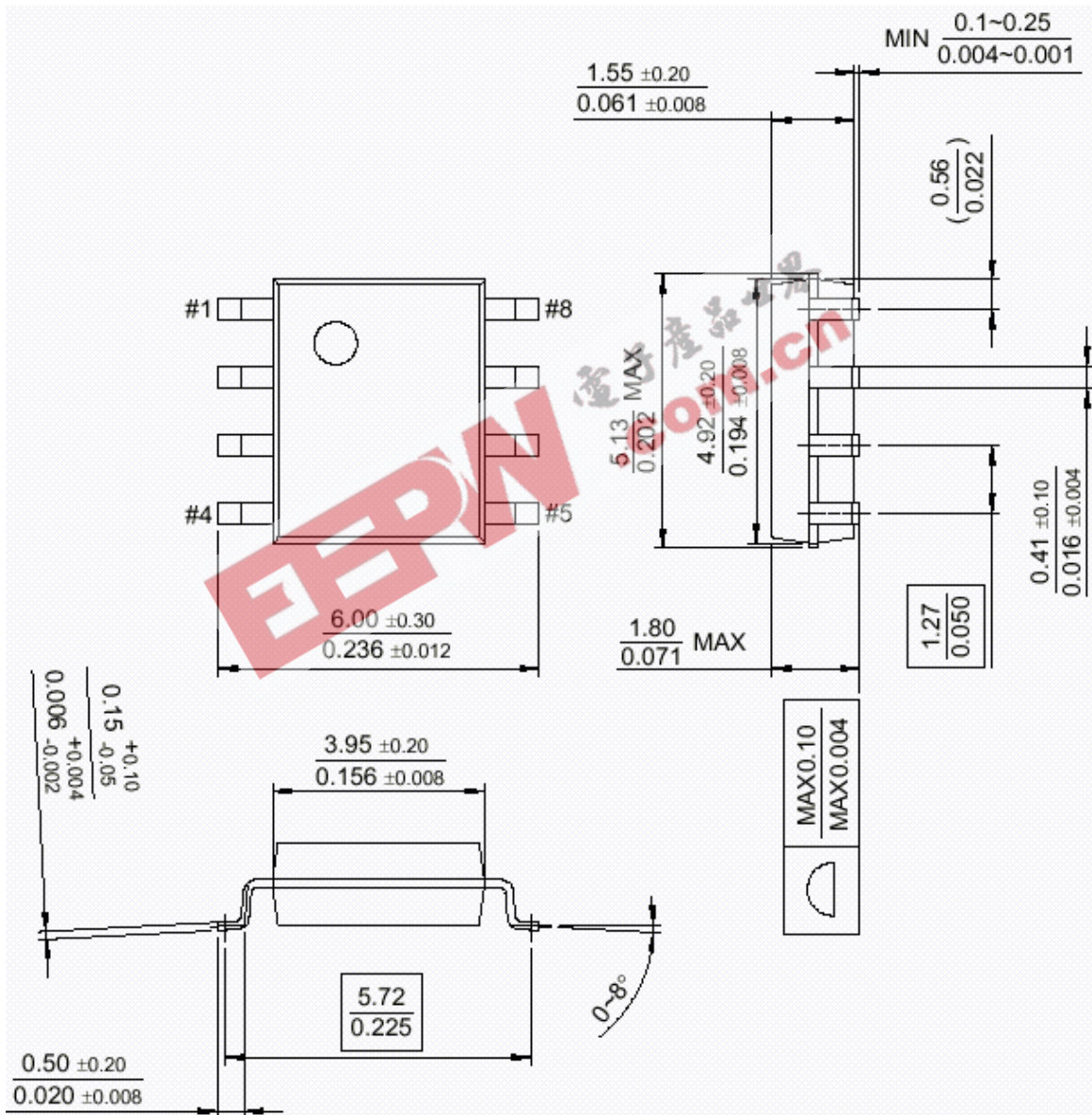

Ordering Information

Device	Package	Operating Temp.
FAN7021M	8-SOP-225	-40°C ~ +85°C

EEPW 电子产品世界
.com.cn



DISCLAIMER

FAIRCHILD SEMICONDUCTOR RESERVES THE RIGHT TO MAKE CHANGES WITHOUT FURTHER NOTICE TO ANY PRODUCTS HEREIN TO IMPROVE RELIABILITY, FUNCTION OR DESIGN. FAIRCHILD DOES NOT ASSUME ANY LIABILITY ARISING OUT OF THE APPLICATION OR USE OF ANY PRODUCT OR CIRCUIT DESCRIBED HEREIN; NEITHER DOES IT CONVEY ANY LICENSE UNDER ITS PATENT RIGHTS, NOR THE RIGHTS OF OTHERS.

LIFE SUPPORT POLICY

FAIRCHILD'S PRODUCTS ARE NOT AUTHORIZED FOR USE AS CRITICAL COMPONENTS IN LIFE SUPPORT DEVICES OR SYSTEMS WITHOUT THE EXPRESS WRITTEN APPROVAL OF THE PRESIDENT OF FAIRCHILD SEMICONDUCTOR CORPORATION. As used herein:

1. Life support devices or systems are devices or systems which, (a) are intended for surgical implant into the body, or (b) support or sustain life, and (c) whose failure to perform when properly used in accordance with instructions for use provided in the labeling, can be reasonably expected to result in a significant injury of the user.
2. A critical component in any component of a life support device or system whose failure to perform can be reasonably expected to cause the failure of the life support device or system, or to affect its safety or effectiveness.