

T-75-37-05

F6850/F68A50/F68B50 Asynchronous Communications Interface Adapter (ACIA)

Microprocessor Product

Description

The F6850 Asynchronous Communications Interface Adapter (ACIA) provides the data formatting and control to interface serial asynchronous data communications information to bus-organized systems, such as the F6800 microprocessing unit (MPU).

The bus interface of the F6850 includes select, enable read/write, interrupt, and bus interface logic to allow data transfer over an 8-bit bidirectional data bus. The parallel data of the bus system is serially transmitted and received by the asynchronous data interface, with proper formatting and error checking. The functional configuration of the ACIA is programmed via the data bus during system initialization. A programmable control register provides variable word lengths, clock division ratios, transmit control, receive control, and interrupt control. For peripheral or modem operation, three control lines are provided. These lines allow the ACIA to interface directly with a 0-600 bps modem.

- 8- and 9-Bit Transmission
- Optional Even and Odd Parity
- Parity, Overrun, and Framing Error Checking
- Programmable Control Register
- Optional +1, +16, and +64 Clock Modes
- Up to 1.0 Mbps Transmission
- False Start Bit Deletion
- Peripheral/Modem Control Functions
- Double Buffered
- One or Two Stop Bit Operation

Pin Functions

D ₀ -D ₇	Bidirectional Data Lines
Rx DATA	Receive Data Input
Rx CLK	Receive Clock Input
Tx CLK	Transmit Clock Input
CS ₀ , CS ₁ , CS ₂	Chip Select Inputs
RS	Register Select Input
CTS	Clear-to-Send Input
E	Enable Input
R/W	Read/Write Input
RTS	Request-to-Send Output
Tx DATA	Transmit Data Output
IRQ	Interrupt Request Output
DCD	Data Carrier Detect Output

Logic Symbol

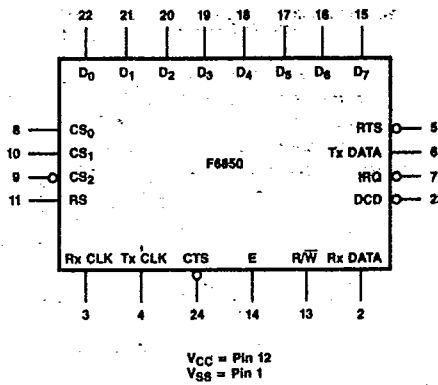

5

Connection Diagram 24-Pin DIP

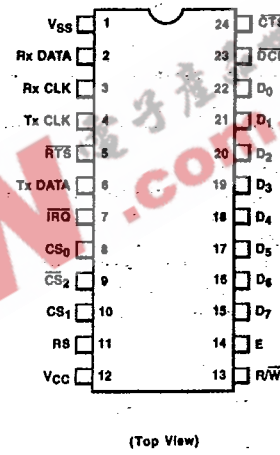

(Top View)

T-75-37-05

synchronization in the divide-by-16 and -64 modes is initiated by the detection of 8 or 32 LOW samples, respectively, on the receive data line. False start bit deletion capability ensures that a full half bit of a start bit has been received before the internal clock is synchronized to the bit time. As a character is being received, parity (odd or even) is checked and the error indication made available in the status register along with framing error, overrun error, and receive data register full. In a typical receiving sequence, the status register is read to determine if a character has been received from a peripheral. If the receive data is full, the character is placed on the 8-bit ACIA bus when a read data command is received from the MPU. When parity has been selected for an 8-bit word (seven bits plus parity), the receiver strips the parity bit ($D_7 = 0$) so that data alone is transferred to the MPU. This feature reduces MPU programming. The status register can be read again to determine when another character is available in the receive data register. The receiver is also double buffered so that a character can be read from the data register as another character is being received in the shift register. The above sequence continues until all characters have been received.

Input/Output Functions

The ACIA interfaces to the F6800 MPU through an 8-bit bidirectional data bus, three chip select lines, a register select line, an interrupt request line, read/write line, and enable line. These signals, in conjunction with F6800 VMA output, permit the MPU to have complete control over the ACIA.

ACIA Bidirectional Data ($D_0 - D_7$)

The bidirectional data lines ($D_0 - D_7$) allow for data transfer between the ACIA and the MPU. The data bus output drivers are 3-state devices that remain in the high-impedance (OFF) state except when the MPU performs an ACIA read operation.

ACIA Enable (E)

The enable signal (E) is a high-impedance, TTL-compatible input that enables the bus input/output data buffers and clocks data to and from the ACIA. This signal normally is a derivative of the F6800 $\phi 2$ clock.

Read/Write (R/\bar{W})

The read/write line is a high-impedance input that is TTL-compatible and is used to control the direction of data flow through the ACIA input/output data bus interface. When R/\bar{W} is HIGH (MPU read cycle), ACIA output drivers are turned on and a selected register is read. When it is LOW, the ACIA output drivers are turned off and the MPU writes into a selected register. Therefore, the R/\bar{W} signal is used to select read-only or write-only registers within the ACIA.

Chip Select (CS_0, CS_1, \bar{CS}_2)

These three high-impedance, TTL-compatible input lines are used to address the ACIA. The ACIA is selected when CS_0 and CS_1 are HIGH and \bar{CS}_2 is LOW. Transfers of data to and from the ACIA are then performed under the control of the E, R/\bar{W} , and RS signals.

Register Select (RS)

The register select line is a high-impedance input that is TTL-compatible. A HIGH level is used to select the transmit/receive data registers and a LOW level the control/status registers. The R/\bar{W} signal line is used in conjunction with RS to select the read-only or write-only register in each register pair.

Interrupt Request (\bar{IRQ})

Interrupt request is a TTL-compatible, open-drain (no internal pull-up), active-LOW output that is used to interrupt the MPU. The \bar{IRQ} output remains LOW as long as the cause of the interrupt is present and the appropriate interrupt enable within the ACIA is set. The \bar{IRQ} status bit, when HIGH, indicates that the \bar{IRQ} output is in the active state.

Interrupts result from conditions in both the transmitter and receiver sections of the ACIA. The transmitter section causes an interrupt when the transmitter interrupt enabled condition is selected ($CR_5 \cdot CR_6$), and the transmit data register empty (TDRE) status bit is HIGH. The TDRE status bit indicates the current status of the transmitter data register except when inhibited by the \bar{CTS} line being HIGH or the ACIA being maintained in the reset condition. The interrupt is cleared by writing data into the transmit data register. The interrupt is masked by disabling the transmitter interrupt via CR_5 or CR_6 , or by the loss of \bar{CTS} , which inhibits the TDRE status bit. The receiver section causes an interrupt when the receiver interrupt enable is set and the receive data register full (RDRF) status bit is HIGH, an overrun has occurred, or the data carrier detect (\bar{DCD}) line has gone HIGH. An interrupt resulting from the RDRF status bit can be cleared by reading data or resetting the ACIA. Interrupts caused by overrun or loss of \bar{DCD} are cleared by reading the status register after the error condition has occurred and then reading the receive data register or resetting the ACIA. The receiver interrupt is masked by resetting the receiver interrupt enable.

Clock Inputs

Separate high-impedance, TTL-compatible inputs are provided for clocking of transmitted and received data. Clock frequencies of 1, 16, or 64 times the data rate may be selected.

Transmit Clock (Tx CLK)

The transmit clock input is used for the clocking of transmitted data. The transmitter initiates data on the negative transition of the clock.

5

Receive Clock (Rx CLK)

The receive clock input is used for synchronization of received data. (In the ± 1 mode, the clock and data must be synchronized externally.) The receiver samples the data on the positive transition of the clock.

Serial Input/Output Lines**Receive Data (Rx DATA)**

The receive data line is a high-impedance, TTL-compatible input through which data is received in a serial format. Synchronization with a clock for detection of data is accomplished internally when clock rates of 16 or 64 times the bit rate are used.

Transmit Data (Tx DATA)

The transmit data output line transfers serial data to a modem or other peripheral.

Peripheral/Modem Control

The ACIA includes several functions that permit limited control of a peripheral or modem. The functions included are clear-to-send, request-to-send and data carrier detect.

Clear-to-Send (CTS)

This high-impedance, TTL-compatible input provides automatic control of the transmitting end of a communications link via the modem clear-to-send active-LOW output by inhibiting the transmit data register empty (TDRE) status bit.

Request-to-Send (RTS)

The request-to-send output enables the MPU to control a peripheral or modem via the data bus. The RTS output corresponds to the state of control register bits CR₅ and CR₆. When CR₆ = 0 or both CR₅ and CR₆ = 1, the RTS output is LOW (the active state.) This output can also be used for data terminal ready (DTR).

Data Carrier Detect (DCD)

This high-impedance, TTL-compatible input provides automatic control, such as in the receiving end of a communications link, by means of a modem Data Carrier Detect output. The DCD input inhibits and initializes the receiver section of the ACIA when HIGH. A LOW-to-HIGH transition of DCD initiates an interrupt to the MPU to indicate the occurrence of a loss of carrier when the receive interrupt enable bit is set. The RxCLK must be running for proper DCD operation.

ACIA Registers

The block diagram for the ACIA indicates the internal registers on the chip that are used for the status, control, receiving, and transmitting of data. The content of each of the registers is summarized in Table 1.

Transmit Data Register (TDR)

Data is written into the transmit data register during the negative transition of the E (Enable) pulse when the ACIA has been addressed with RS HIGH and R/W LOW. Writing data into the register causes the TDRE bit in the status register to go LOW. Data can then be transmitted. If the transmitter is idling and no character is being transmitted, the transfer takes place within one bit time of the trailing edge of the write command. If a character is being transmitted, the new data character commences as soon as the previous character is complete. The transfer of data causes the TDRE bit to indicate empty.

Receive Data Register (RDR)

Data is automatically transferred to the empty receive data register (RDR) from the receiver deserializer (a shift register) upon receiving a complete character. This event causes the receive data register full (RDRF) bit in the status buffer to go HIGH (full). Data may then be read through the bus by addressing the ACIA and selecting the RDR with RS and R/W HIGH when the ACIA is enabled. The non-destructive read cycle causes the RDRF bit to be cleared to empty although the data is retained in the RDR. The status is maintained by the RDRF bit to indicate whether or not the data is current. When the receive data register is full, the automatic transfer of data from the receiver shift register to the data register is inhibited and the RDR contents remain valid, with its current status stored in the status register.

Control Register

The ACIA control register consists of eight bits of write-only buffer that are selected when RS and R/W are LOW. This register controls the function of the receiver, transmitter, interrupt enables, and the request-to-send peripheral/modem control output.

Counter Divide Select Bits (CR₀ and CR₁)

The counter divide select bits (CR₀ and CR₁) determine the divide ratios utilized in both the transmitter and receiver sections of the ACIA. Additionally, these bits are used to provide a master reset for the ACIA that clears the status register (except for external conditions on CTS and DCD) and initializes both the receiver and transmitter. Master reset does not affect other control register bits. Note that after power-on or a power fail/start, these bits must be set HIGH to reset the ACIA. After resetting, the clock divide ratio may be selected.

T-75-37-05

Table 1 Definition of ACIA Register Contents

Data Bus Line Number	Buffer Address			
	RS · R/W Transmit Data Register	RS · R/W Receive Data Register	RS · R/W Control Register	RS · R/W Status Register
	(Write Only)	(Read Only)	(Write Only)	(Read Only)
0	Data Bit 0*	Data Bit 0	Counter Divide Select 1 (CR ₀)	Receive Data Register Full (RDRF)
1	Data Bit 1	Data Bit 1	Counter Divide Select 2 (CR ₁)	Transmit Data Register Empty (TDRE)
2	Data Bit 2	Data Bit 2	Word Select 1 (CR ₂)	Data Carrier Detect (DCD)
3	Data Bit 3	Data Bit 3	Word Select 2 (CR ₃)	Clear-to-Send (CTS)
4	Data Bit 4	Data Bit 4	Word Select 3 (CR ₄)	Framing Error (FE)
5	Data Bit 5	Data Bit 5	Transmit Control 1 (CR ₅)	Receiver Overrun (OVRN)
6	Data Bit 6	Data Bit 6	Transmit Control 2 (CR ₆)	Parity Error (PE)
7	Data Bit 7***	Data Bit 7**	Receive Interrupt Enable (CR ₇)	Interrupt Request (IRQ)

*Leading bit = LSB = Bit 0 **Data bit is zero in 7-bit plus parity modes. ***Data bit is "don't care" in 7-bit plus parity modes.

These counter select bits provide for the following clock divide ratios:

CR ₁	CR ₀	Function
0	0	÷1
0	1	÷16
1	0	÷64
1	1	Master Reset

request-to-send (RTS) output, and the transmission of a break-level (space). The following encoding format is used:

CR ₆	CR ₅	Function
0	0	RTS = LOW, Transmitting Interrupt Disabled
0	1	RTS = LOW, Transmitting Interrupt Enabled
1	0	RTS = HIGH, Transmitting Interrupt Disabled
1	1	RTS = LOW, Transmits a Break Level on the Transmit Data Output. Transmitting Interrupt Disabled.

Word Select Bits (CR₂, CR₃ and CR₄)

The word select bits are used to select word length, parity, and the number of stop bits. The encoding format is as follows:

CR ₄	CR ₃	CR ₂	Function
0	0	0	7 Bits + Even Parity + 2 Stop Bits
0	0	1	7 Bits + Odd Parity + 2 Stop Bits
0	1	0	7 Bits + Even Parity + 1 Stop Bit
0	1	1	7 Bits + Odd Parity + 1 Stop Bit
1	0	0	8 Bits + 2 Stop Bits
1	0	1	8 Bits + 1 Stop Bit
1	1	0	8 Bits + Even Parity + 1 Stop Bit
1	1	1	8 Bits + Odd Parity + 1 Stop Bit

Word length, parity select, and stop bit changes are not buffered and therefore become effective immediately.

Transmitter Control Bits (CR₅ and CR₆)

Two transmitter control bits provide for the control of the interrupt from the transmit data register empty condition, the

Receive Interrupt Enable Bit (CR₇)

The following interrupts are enabled by a HIGH level in bit position 7 of the control register (CR₇): receive data register full, overrun, or a LOW-to-HIGH transition on the data carrier detect (DCD) signal line.

Status Register

Information on the status of the ACIA is available to the MPU by reading the ACIA status register. This read-only register is selected when RS is LOW and R/W is HIGH. Information stored in this register indicates the status of the transmit data register, the receive data register and error logic, and the peripheral/modem status inputs of the ACIA.

Receive Data Register Full (RDRF), Bit 0

Receive data register full indicates that received data has been transferred to the receive data register. The RDRF bit is cleared after an MPU read of the receive data register or by a master reset. The cleared or empty state indicates that the

contents of the receive data register are not current. Data carrier detect being HIGH also causes RDRF to indicate empty.

Transmit Data Register Empty (TDRE), Bit 1

The transmit data register empty bit being set HIGH indicates that the transmit data register contents have been transferred and that new data may be entered. The LOW state indicates that the register is full and that transmission of a new character has not begun since the last write data command.

Data Carrier Detect (DCD), Bit 2

The data carrier detect bit is HIGH when the DCD input from a modem has gone HIGH to indicate that a carrier is not present. This bit going HIGH causes an interrupt request to be generated when the receive interrupt enable is set. It remains HIGH after the DCD input is returned LOW until cleared by reading first the status register and then the data register, or until a master reset occurs. If the DCD input remains HIGH after read status and read data or master reset has occurred, the interrupt is cleared, and the DCD status bit remains HIGH and will follow the DCD input.

Clear-to-Send (CTS), Bit 3

The clear-to-send bit indicates the state of the clear-to-send input from a modem. A LOW CTS indicates that there is a clear-to-send from the modem. In the HIGH state, the transmit data register empty bit is inhibited and the clear-to-send status bit is HIGH. Master reset does not affect the clear-to-send status bit.

Framing Error (FE), Bit 4

Framing error indicates that the received character is improperly framed by a start and a stop bit and is detected by the absence of the first stop bit. This error indicates a synchronization error, faulty transmission, or a break condition. The framing error flag is set or reset during the receive data transfer time. Therefore, this error indicator is present throughout the time that the associated character is available.

Receiver Overrun (OVRN), Bit 5

Overrun is an error flag that indicates that one or more characters in the data stream were lost. That is, a character or a number of characters were received but not read from the receive data register (RDR) prior to subsequent characters being received. The overrun condition begins at the midpoint of the last bit of the second character received in succession without a read of the RDR having occurred. The overrun does not occur in the status register until the valid character prior to overrun has been read. The RDRF bit remains set until the overrun is reset. Character synchronization is maintained during the overrun condition. The overrun indication is reset after the reading of data from the receive data register or by a master reset.

Parity Error (PE), Bit 6

The parity error flag indicates that the number of HIGHS (1's) in the character does not agree with the preselected odd or even parity. Odd parity is defined to be when the total number of ones is odd. The parity error indication is present as long as the data character is in the RDR. If no parity is selected, both the transmitter parity generator output and the receiver parity check results are inhibited.

Interrupt Request (IRQ), Bit 7

The IRQ bit indicates the state of the IRQ output. Any interrupt condition with its applicable enable is indicated in this status bit. Any time the IRQ output is LOW, the IRQ bit is HIGH to indicate the interrupt or service request status. The IRQ bit is cleared by a read operation to the receive data register or a write operation to the transmit data register.

T-7537-05

Absolute Maximum Ratings

Supply Voltage	-0.3 V, +7.0 V
Input Voltage	-0.3 V, +7.0 V
Operating Temperature - T _L , T _H	
F6850, F68A50, F68B50	0°C, +70°C
F6850C, F68A50C	-40°C, +85°C
F6850DL	-55°C, +85°C
F6850DM	-55°C, +125°C
Storage Temperature Range	-55°C, +150°C
Thermal Resistance	
Ceramic	60°C/W
Plastic	120°C/W

This device contains circuitry to protect the inputs against damage due to high static voltages or electrical fields; however, it is advised that normal precautions be taken to avoid application of any voltage higher than maximum rated voltages to this high-impedance circuit.

DC Characteristics V_{CC} = 5.0 V ±5%, V_{SS} = 0, T_A = T_L to T_H, unless otherwise noted

Symbol	Characteristic	Signal	Min	Typ	Max	Unit	Condition
V _{IH}	Input HIGH Voltage		2.0		V _{CC}	V	
V _{IL}	Input LOW Voltage		-0.3		0.8	V	
I _{IN}	Input Leakage Current	R/W, CS ₀ , CS ₁ , CS ₂ , RS, Rx DATA, Rx CLK, CTS, DCD		1.0	2.5	μA	V _{IN} = 0 to 5.25 V
I _{ISI}	3-State Input Current (OFF State)	D ₀ -D ₇		2.0	10	μA	V _{IN} = 0.4 to 2.4 V
V _{OH}	Output HIGH Voltage	D ₀ -D ₇ Tx DATA, RTS	2.4 2.4			V	I _{Load} = -205 μA, Enable Pulse Width < 25 μs I _{Load} = -100 μA, Enable Pulse Width < 25 μs
V _{OL}	Output LOW Voltage				0.4	V	I _{Load} = 1.6 mA, Enable Pulse Width < 25 μs
I _{LOH}	Output Leakage Current	IRQ		1.0	10	μA	V _{OH} = 2.4 V
P _D	Power Dissipation			300	525	mW	
C _{IN}	Input Capacitance	D ₀ -D ₇ , E, Tx CLK, Rx CLK, R/W, RS, Rx DATA, CS ₀ , CS ₁ , CS ₂ , CTS, DCD		10 7.0	12.5 7.5	pF	V _{IN} = 0, T _A = 25°C, f = 1.0 MHz
C _{OUT}	Output Capacitance	RTS, Tx DATA, IRQ			10 5.0	pF	V _{IN} = 0, T _A = 25°C, f = 1.0 MHz

5

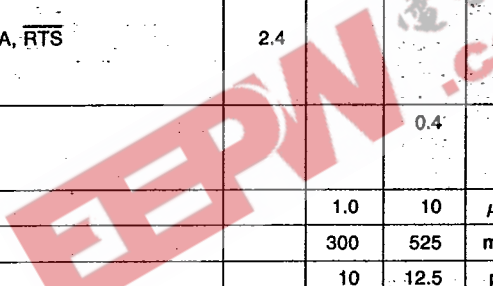

AC Characteristics $V_{CC} = 5.0 V \pm 5\%$, $V_{SS} = 0$, $T_A = T_L$ to T_H , unless otherwise noted

Symbol	Characteristic	F6850		F68A50		F68B50		Unit	Condition
		Min	Max	Min	Max	Min	Max		
PW _{CL}	Minimum Clock Pulse Width, LOW ±16, ±64 Modes	600		450		280		ns	Figure 1
PW _{CH}	Minimum Clock Pulse Width, HIGH ±16, ±64 Modes	600		450		280		ns	Figure 2
f _C	Clock Frequency +1 Mode ±16, ±64 Modes		500 800		750 1000		1000 1500	kHz	
t _{TDD}	Clock-to-Data Delay for Transmitter		600		540		460	ns	Figure 3
t _{RDS}	Receive Data Set-up Time +1 Mode	250		100		30		ns	Figure 4
t _{RDH}	Receive Data Hold Time +1 Mode	250		100		30		ns	Figure 5
t _{IR}	Interrupt Request Release Time		1.2		0.9		0.7	μs	Figure 6
t _{RTS}	Request-to-Send Delay Time		560		480		400	ns	Figure 6
t _r , t _f	Input Transition Times (Except Enable)		1.0		0.5		0.25	μs	Note

Note
1.0 μs or 10% of the pulse width, whichever is smaller

Bus Timing Characteristics
Read (Figures 7 and 9)

Symbol	Characteristic	F6850		F68A50		F68B50		Unit
		Min	Max	Min	Max	Min	Max	
t _{cycE}	Enable Cycle Time	1.0		0.666		0.500		μs
PW _{EH}	Enable Pulse Width, HIGH	0.45	25	0.28	25	0.22	25	μs
PW _{EL}	Enable Pulse Width, LOW	0.43		0.28		0.21		μs
t _{AS}	Set-up Time, Address, and R/W Valid to Enable Positive Transition	160		140		70		ns
t _{DDR}	Data Delay Time		320		220		180	ns
t _H	Data Hold Time	10		10		10		ns
t _{AH}	Address Hold Time	10		10		10		ns
t _r , t _f	Rise and Fall Time for Enable Input		25		25		25	ns

Write (Figures 8 and 9)

t _{cycE}	Enable Cycle Time	1.0		0.666		0.500		μs
PW _{EH}	Enable Pulse Width, HIGH	0.45	25	0.28	25	0.22	25	μs
PW _{EL}	Enable Pulse Width, LOW	0.43		0.28		0.21		μs
t _{AS}	Set-up Time, Address, and R/W Valid to Enable Positive Transition	160		140		70		ns
t _{DSW}	Data Set-up Time	195		80		60		ns
t _H	Data Hold Time	10		10		10		ns
t _{AH}	Address Hold Time	10		10		10		ns
t _r , t _f	Rise and Fall Time for Enable Input		25		25		25	ns

Fig. 1 Clock Pulse Width, LOW State

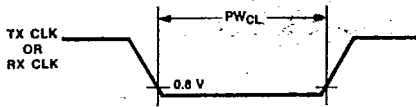

Fig. 2 Clock Pulse Width, HIGH State

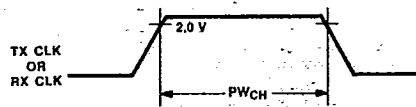

Fig. 3 Transmit Data Output Delay

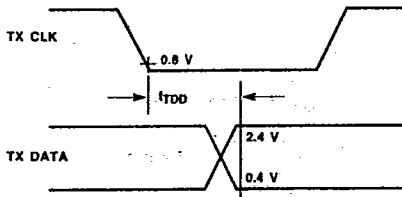

Fig. 4 Receive Data Set-up Time (+1 Mode)

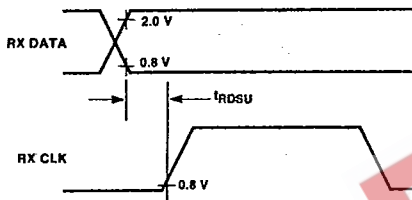

Fig. 5 Receive Data Hold Time (+1 Mode)

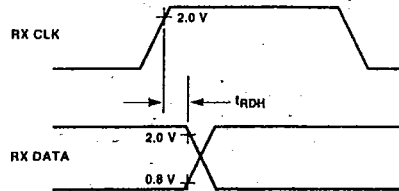
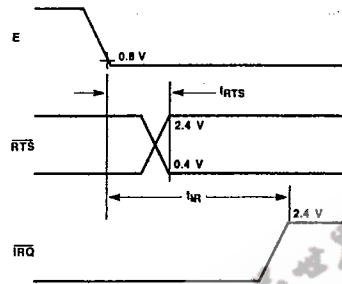

Fig. 6 Request-to-Send Delay and Interrupt Request Release Times



5

Fig. 7 Bus Read Timing Characteristics (Read Information from ACIA)

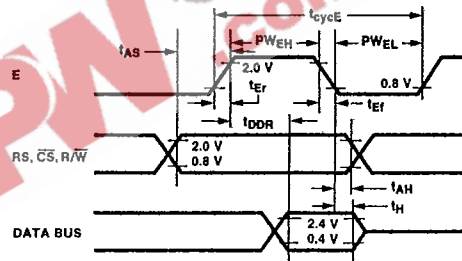

Fig. 8 Bus Write Timing Characteristics
(Write Information into ACIA)

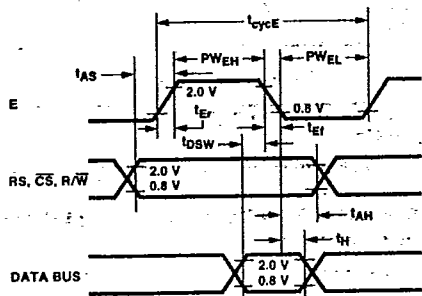
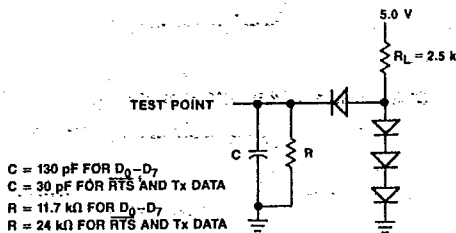

Fig. 9 Bus Timing Test Loads

Load A ($D_0-D_7, \overline{RTS}, Tx DATA$)



C = 130 pF FOR D_0-D_7
 C = 30 pF FOR \overline{RTS} AND Tx DATA
 R = 11.7 k Ω FOR D_0-D_7
 R = 24 k Ω FOR \overline{RTS} AND Tx DATA

Load B (\overline{IRQ} Only)

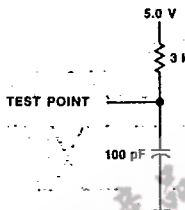

EPW.com.cn
 电子产业世界

T-75-37-05

Ordering Information

Speed	Order Code	Temperature Range
1.0 MHz	F6850P,S	0°C to +70°C
	F6850CP,CS	-40°C to +85°C
	F6850DL	-55°C to +85°C
	F6850DM	-55°C to +125°C
1.5 MHz	F68A50P,S	0°C to +70°C
	F68A50CP,CS	-40°C to +85°C
2.0 MHz	F68B50P,S	0°C to +70°C

P = Plastic package, S = Ceramic package

EEPW 电子产品世界 .com.cn