

**PSM Step-up DC/DC Converter****Features**

- 1~4 Cell Alkaline Battery Operating Range
- Output Voltage Range: 2.5V~5.0V in 0.1V Increments
- Minimum External Component (L, D, C)
- 100KHz Max. Oscillation Frequency
- 75% Duty Ratio
- Up to 80% Efficiency
- $\pm 2\%$  High Output Voltage Accuracy
- $< 100\text{ppm}/^\circ\text{C}$  Temperature Coefficient
- SOT-89 and SOT-23-5 Small Packages

**Applications**

- Power Source for Portable Equipments
- Handheld Computers, Palmtops
- Digital Still Cameras, Camcorders
- Cellular Phones, Pagers
- Portable Multimedia Players

**General Description**

The G5130/G5131 boost converter is designed for use of main power source on portable equipments.

It consist of an oscillator, PSM control logic circuit, an embedded power MOS (LX switch), accurate voltage reference, error amplifier, feedback resistors, and LX protection circuit.

Only 3 external components (includes 1 inductor, 1 diode and 1 capacitor) are needed to construct the power application.

For larger output power application, G5131 can be used to drive an external NPN device for more input current.

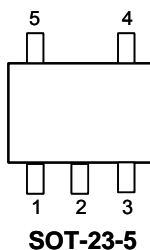
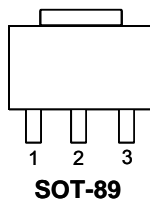
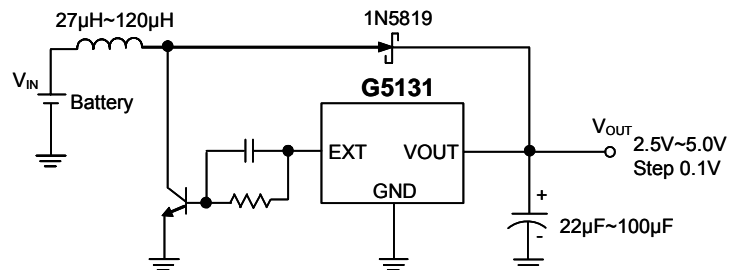
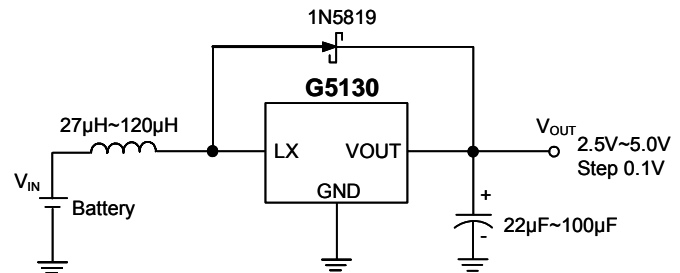
**Pin Configuration****Typical Application Circuit**

**Ordering Information**

ORDER NUMBER	ORDER NUMBER (Pb free)	MARKING	OUTPUT VOLTAGE (V)	TEMP. RANGE	PACKAGE
G5130-30T11U	G5130-30T11Uf	EA30x	3.0	-40°C ~ +85°C	SOT-23-5
G5130-33T11U	G5130-33T11Uf	EA33x	3.3	-40°C ~ +85°C	SOT-23-5
G5130-42T11U	G5130-42T11Uf	EA42x	4.2	-40°C ~ +85°C	SOT-23-5
G5130-50T11U	G5130-50T11Uf	EA50x	5.0	-40°C ~ +85°C	SOT-23-5
G5130-30T21U	G5130-30T21Uf	5130Fx	3.0	-40°C ~ +85°C	SOT-89
G5130-33T21U	G5130-33T21Uf	5130Ix	3.3	-40°C ~ +85°C	SOT-89
G5130-42T21U	G5130-42T21Uf	5130Rx	4.2	-40°C ~ +85°C	SOT-89
G5130-50T21U	G5130-50T21Uf	5130Zx	5.0	-40°C ~ +85°C	SOT-89
G5131-30T11U	G5131-30T11Uf	EB30x	3.0	-40°C ~ +85°C	SOT-23-5
G5131-33T11U	G5131-33T11Uf	EB33x	3.3	-40°C ~ +85°C	SOT-23-5
G5131-42T11U	G5131-42T11Uf	EB42x	4.2	-40°C ~ +85°C	SOT-23-5
G5131-50T11U	G5131-50T11Uf	EB50x	5.0	-40°C ~ +85°C	SOT-23-5
G5131-30T21U	G5131-30T21Uf	5131Fx	3.0	-40°C ~ +85°C	SOT-89
G5131-33T21U	G5131-33T21Uf	5131Ix	3.3	-40°C ~ +85°C	SOT-89
G5131-42T21U	G5131-42T21Uf	5131Rx	4.2	-40°C ~ +85°C	SOT-89
G5131-50T21U	G5131-50T21Uf	5131Zx	5.0	-40°C ~ +85°C	SOT-89

For other output voltage, please contact us at sales@gmt.com.tw

**Order Number Identification**

GXXXX-XX-XX X X

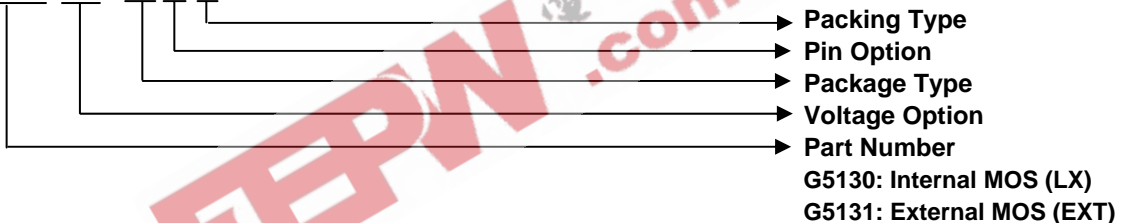
**PACKAGE TYPE**

T1 : SOT-23-5

T2 : SOT-89

**PIN OPTION****SOT89****SOT23-5****PACKING**

U & D: Tape & Reel Direction

	1	2	3	1	2	3	4	5
<b>G5130</b>	1:GND	VOUT	LX	1: CE	VOUT	NC	GND	LX
<b>G5131</b>	1:GND	VOUT	EXT	1: CE	VOUT	NC	GND	EXT



## Selector Guide

ORDER NUMBER	ORDER NUMBER (Pb free)	OUTPUT VOLTAGE (V)	MARKING
G5130-25T11U	G5130-25T11Uf	2.5	EA25x
G5130-26T11U	G5130-26T11Uf	2.6	EA26x
G5130-27T11U	G5130-27T11Uf	2.7	EA27x
G5130-28T11U	G5130-28T11Uf	2.8	EA28x
G5130-29T11U	G5130-29T11Uf	2.9	EA29x
G5130-30T11U	G5130-30T11Uf	3.0	EA30x
G5130-31T11U	G5130-31T11Uf	3.1	EA31x
G5130-32T11U	G5130-32T11Uf	3.2	EA32x
G5130-33T11U	G5130-33T11Uf	3.3	EA33x
G5130-34T11U	G5130-34T11Uf	3.4	EA34x
G5130-35T11U	G5130-35T11Uf	3.5	EA35x
G5130-36T11U	G5130-36T11Uf	3.6	EA36x
G5130-37T11U	G5130-37T11Uf	3.7	EA37x
G5130-38T11U	G5130-38T11Uf	3.8	EA38x
G5130-39T11U	G5130-39T11Uf	3.9	EA39x
G5130-40T11U	G5130-40T11Uf	4.0	EA40x
G5130-41T11U	G5130-41T11Uf	4.1	EA41x
G5130-42T11U	G5130-42T11Uf	4.2	EA42x
G5130-43T11U	G5130-43T11Uf	4.3	EA43x
G5130-44T11U	G5130-44T11Uf	4.4	EA44x
G5130-45T11U	G5130-45T11Uf	4.5	EA45x
G5130-46T11U	G5130-46T11Uf	4.6	EA46x
G5130-47T11U	G5130-47T11Uf	4.7	EA47x
G5130-48T11U	G5130-48T11Uf	4.8	EA48x
G5130-49T11U	G5130-49T11Uf	4.9	EA49x
G5130-50T11U	G5130-50T11Uf	5.0	EA50x

Note: T1: SOT-23-5

## Selector Guide

ORDER NUMBER	ORDER NUMBER (Pb free)	OUTPUT VOLTAGE (V)	MARKING
G5130-25T21U	G5130-25T21Uf	2.5	5130Ax
G5130-26T21U	G5130-26T21Uf	2.6	5130Bx
G5130-27T21U	G5130-27T21Uf	2.7	5130Cx
G5130-28T21U	G5130-28T21Uf	2.8	5130Dx
G5130-29T21U	G5130-29T21Uf	2.9	5130Ex
G5130-30T21U	G5130-30T21Uf	3.0	5130Fx
G5130-31T21U	G5130-31T21Uf	3.1	5130Gx
G5130-32T21U	G5130-32T21Uf	3.2	5130Hx
G5130-33T21U	G5130-33T21Uf	3.3	5130Ix
G5130-34T21U	G5130-34T21Uf	3.4	5130Jx
G5130-35T21U	G5130-35T21Uf	3.5	5130Kx
G5130-36T21U	G5130-36T21Uf	3.6	5130Lx
G5130-37T21U	G5130-37T21Uf	3.7	5130Mx
G5130-38T21U	G5130-38T21Uf	3.8	5130Nx
G5130-39T21U	G5130-39T21Uf	3.9	5130Ox
G5130-40T21U	G5130-40T21Uf	4.0	5130Px
G5130-41T21U	G5130-41T21Uf	4.1	5130Qx
G5130-42T21U	G5130-42T21Uf	4.2	5130Rx
G5130-43T21U	G5130-43T21Uf	4.3	5130Sx
G5130-44T21U	G5130-44T21Uf	4.4	5130Tx
G5130-45T21U	G5130-45T21Uf	4.5	5130Ux
G5130-46T21U	G5130-46T21Uf	4.6	5130Vx
G5130-47T21U	G5130-47T21Uf	4.7	5130Wx
G5130-48T21U	G5130-48T21Uf	4.8	5130Xx
G5130-49T21U	G5130-49T21Uf	4.9	5130Yx
G5130-50T21U	G5130-50T21Uf	5.0	5130Zx

Note: T2: SOT-89



## Selector Guide

ORDER NUMBER	ORDER NUMBER (Pb free)	OUTPUT VOLTAGE (V)	MARKING
G5131-25T11U	G5131-25T11Uf	2.5	EB25x
G5131-26T11U	G5131-26T11Uf	2.6	EB26x
G5131-27T11U	G5131-27T11Uf	2.7	EB27x
G5131-28T11U	G5131-28T11Uf	2.8	EB28x
G5131-29T11U	G5131-29T11Uf	2.9	EB29x
G5131-30T11U	G5131-30T11Uf	3.0	EB30x
G5131-31T11U	G5131-31T11Uf	3.1	EB31x
G5131-32T11U	G5131-32T11Uf	3.2	EB32x
G5131-33T11U	G5131-33T11Uf	3.3	EB33x
G5131-34T11U	G5131-34T11Uf	3.4	EB34x
G5131-35T11U	G5131-35T11Uf	3.5	EB35x
G5131-36T11U	G5131-36T11Uf	3.6	EB36x
G5131-37T11U	G5131-37T11Uf	3.7	EB37x
G5131-38T11U	G5131-38T11Uf	3.8	EB38x
G5131-39T11U	G5131-39T11Uf	3.9	EB39x
G5131-40T11U	G5131-40T11Uf	4.0	EB40x
G5131-41T11U	G5131-41T11Uf	4.1	EB41x
G5131-42T11U	G5131-42T11Uf	4.2	EB42x
G5131-43T11U	G5131-43T11Uf	4.3	EB43x
G5131-44T11U	G5131-44T11Uf	4.4	EB44x
G5131-45T11U	G5131-45T11Uf	4.5	EB45x
G5131-46T11U	G5131-46T11Uf	4.6	EB46x
G5131-47T11U	G5131-47T11Uf	4.7	EB47x
G5131-48T11U	G5131-48T11Uf	4.8	EB48x
G5131-49T11U	G5131-49T11Uf	4.9	EB49x
G5131-50T11U	G5131-50T11Uf	5.0	EB50x

Note: T1: SOT-23-5

## Selector Guide

ORDER NUMBER	ORDER NUMBER (Pb free)	OUTPUT VOLTAGE (V)	MARKING
G5131-25T21U	G5131-25T21Uf	2.5	5131Ax
G5131-26T21U	G5131-26T21Uf	2.6	5131Bx
G5131-27T21U	G5131-27T21Uf	2.7	5131Cx
G5131-28T21U	G5131-28T21Uf	2.8	5131Dx
G5131-29T21U	G5131-29T21Uf	2.9	5131Ex
G5131-30T21U	G5131-30T21Uf	3.0	5131Fx
G5131-31T21U	G5131-31T21Uf	3.1	5131Gx
G5131-32T21U	G5131-32T21Uf	3.2	5131Hx
G5131-33T21U	G5131-33T21Uf	3.3	5131Ix
G5131-34T21U	G5131-34T21Uf	3.4	5131Jx
G5131-35T21U	G5131-35T21Uf	3.5	5131Kx
G5131-36T21U	G5131-36T21Uf	3.6	5131Lx
G5131-37T21U	G5131-37T21Uf	3.7	5131Mx
G5131-38T21U	G5131-38T21Uf	3.8	5131Nx
G5131-39T21U	G5131-39T21Uf	3.9	5131Ox
G5131-40T21U	G5131-40T21Uf	4.0	5131Px
G5131-41T21U	G5131-41T21Uf	4.1	5131Qx
G5131-42T21U	G5131-42T21Uf	4.2	5131Rx
G5131-43T21U	G5131-43T21Uf	4.3	5131Sx
G5131-44T21U	G5131-44T21Uf	4.4	5131Tx
G5131-45T21U	G5131-45T21Uf	4.5	5131Ux
G5131-46T21U	G5131-46T21Uf	4.6	5131Vx
G5131-47T21U	G5131-47T21Uf	4.7	5131Wx
G5131-48T21U	G5131-48T21Uf	4.8	5131Xx
G5131-49T21U	G5131-49T21Uf	4.9	5131Yx
G5131-50T21U	G5131-50T21Uf	5.0	5131Zx

Note: T2: SOT-89

**Absolute Maximum Ratings**

LX to GND.....	-0.3V to +7V	Junction Temperature .....	+125°C
CE to GND.....	-0.3V to +7V	Storage Temperature.....	-65°C to +150°C
VOUT to GND.....	-0.3V to +7V	Reflow Temperature (soldering, 10 sec).....	+260°C
Operating Temperature Range (Note 1).....	-40°C to +85°C		

Stress beyond those listed under "Absolute Maximum Rating" may cause permanent damage to the device.

**Electrical Characteristics**

(V<sub>OUT</sub> = 3.3V, V<sub>IN</sub> = 1.8V, T<sub>A</sub> = 25°C)

PARAMETER	CONDITION	MIN	TYP	MAX	UNIT
Output Voltage Accuracy		-2	---	+2	%
Input Voltage Range		---	---	6.5	V
Start-up Voltage		---	0.9	---	V
Hold-on Voltage		---	0.5	---	V
Input Current	No Switching (I <sub>DD2</sub> )	---	10	15	μA
	Switching (I <sub>DD1</sub> )	---	20	---	μA
	No Load (I <sub>IN</sub> )	---	30	---	μA
LX Switch On Resistance	V <sub>LX</sub> = 0.4V	---	2	6	Ω
LX Leakage Current	V <sub>LX</sub> = 6.0V	---	---	0.1	μA
Maximum Oscillation Frequency		70	100	130	KHz
Duty Cycle		65	75	85	%
V <sub>LX</sub> Voltage Limit		---	1	---	V
Efficiency		---	80	---	%

Note 1: The G5130 are guaranteed to meet performance specifications from 0°C to 85°C. Specifications over the -40°C to 85°C operating temperature range are assured by design, characterization and correlation with statistical process controls.

**Block Diagram**

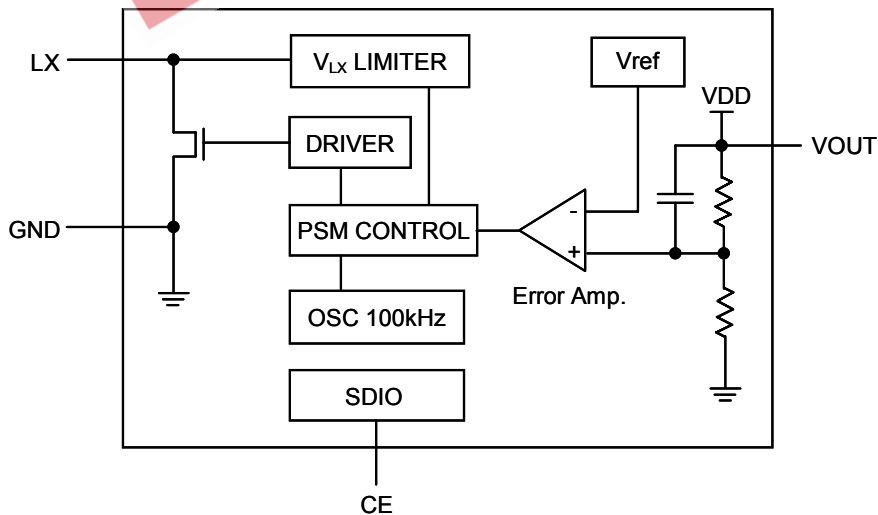

**Typical Performance Characteristics**

( $V_{IN} = +3.0V$ ,  $L = 100\mu H$ ,  $T_A = 25^\circ C$ , unless otherwise noted.)

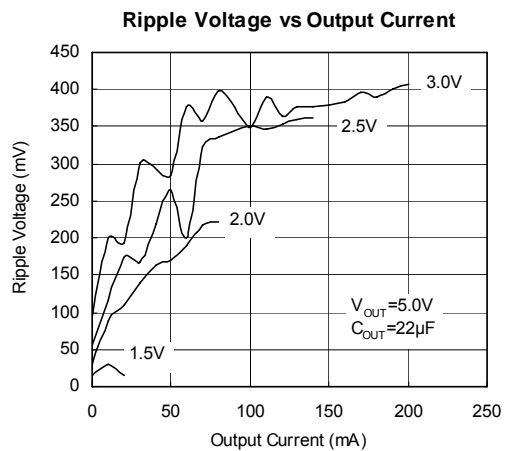
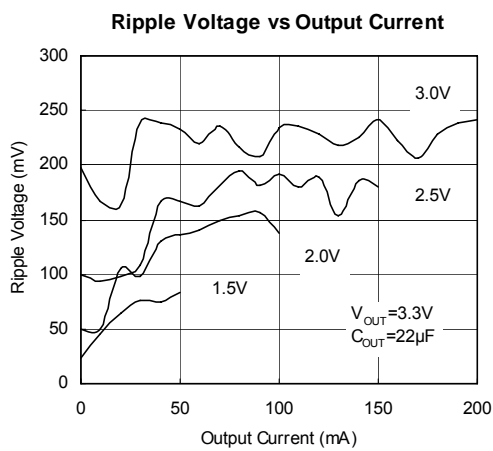
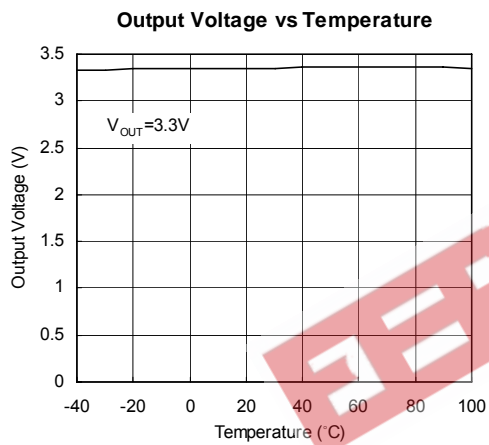
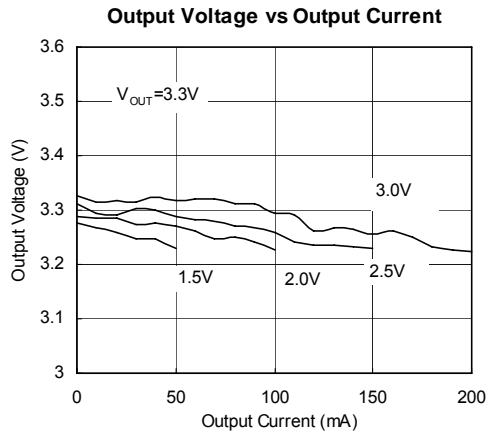

Typical Performance Characteristics (continued)

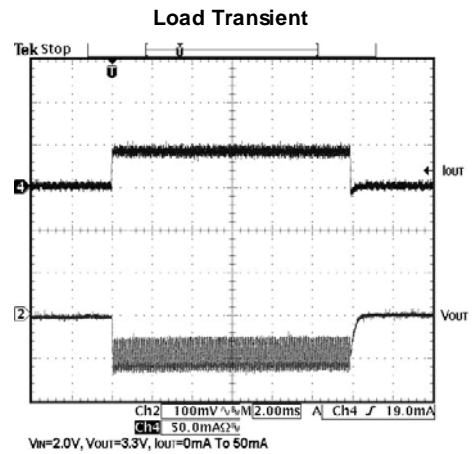
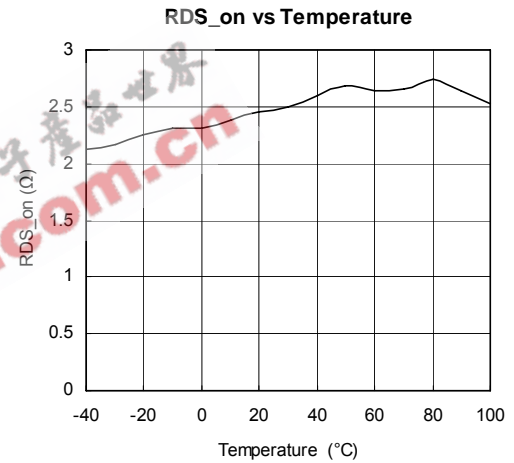
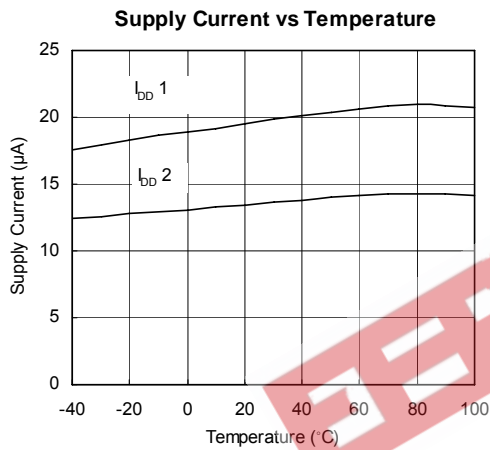
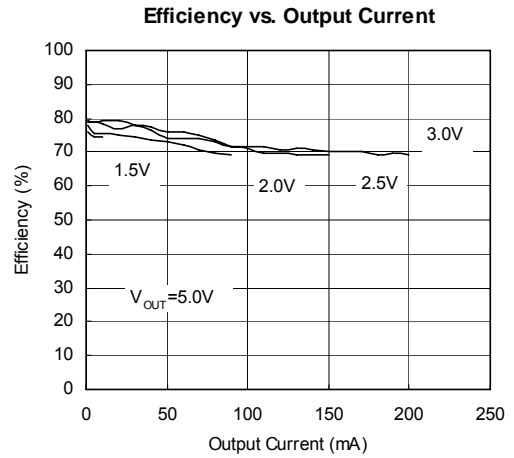
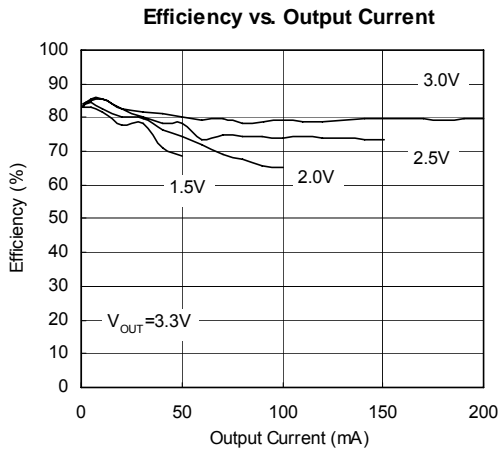

Typical Performance Characteristics (continued)



Recommended Minimum Footprint

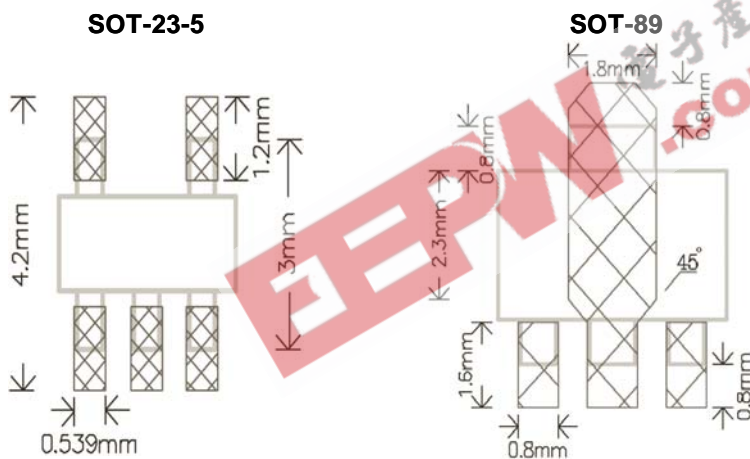



**Package Information**

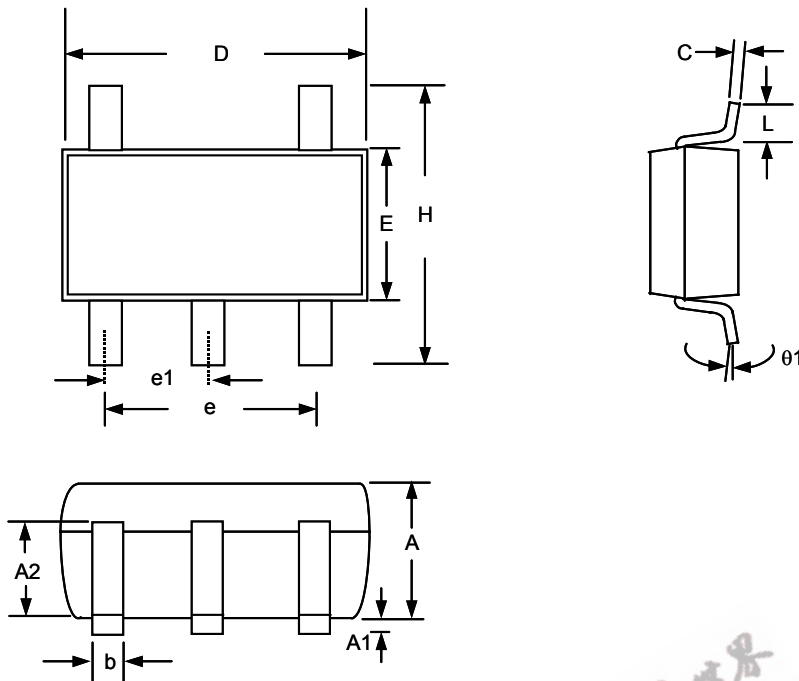

**SOT-23-5 (T1) Package**

**Note:**

1. Package body sizes exclude mold flash protrusions or gate burrs
2. Tolerance  $\pm 0.1000$  mm (4mil) unless otherwise specified
3. Coplanarity: 0.1000mm
4. Dimension L is measured in gage plane

SYMBOL	DIMENSIONS IN MILLIMETER		
	MIN	NOM	MAX
A	1.00	1.10	1.30
A1	0.00	----	0.10
A2	0.70	0.80	0.90
b	0.35	0.40	0.50
C	0.10	0.15	0.25
D	2.70	2.90	3.10
E	1.40	1.60	1.80
e	----	1.90(TYP)	----
e1	----	0.95	----
H	2.60	2.80	3.00
L	0.37	-----	-----
$\theta 1$	1°	5°	9°

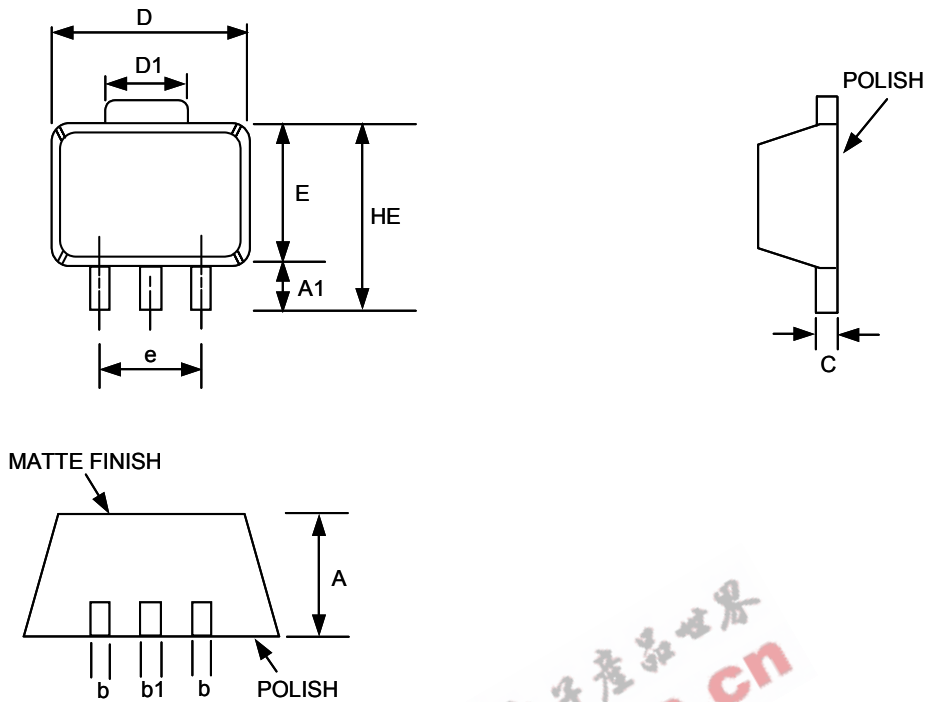

SOT-89 (T2) Package

SYMBOL	DIMENSIONS IN MILLIMETER			DIMENSIONS IN INCH		
	MIN	NOM	MAX	MIN	NOM	MAX
A	1.40	1.50	1.60	0.055	0.059	0.063
A1	0.80	1.04	----	0.031	0.041	----
b	0.36	0.42	0.48	0.014	0.016	0.018
b1	0.41	0.47	0.53	0.016	0.018	0.020
C	0.38	0.40	0.43	0.014	0.015	0.017
D	4.40	4.50	4.60	0.173	0.177	0.181
D1	1.40	1.60	1.75	0.055	0.062	0.069
HE	----	----	4.25	----	----	0.167
E	2.40	2.50	2.60	0.094	0.098	0.102
e	2.90	3.00	3.10	0.114	0.118	0.122

**Taping Specification**

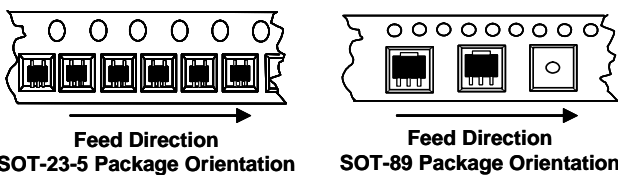

PACKAGE	Q'TY/REEL
SOT-23-5	3,000 ea
SOT-89	1,000 ea

GMT Inc. does not assume any responsibility for use of any circuitry described, no circuit patent licenses are implied and GMT Inc. reserves the right at any time without notice to change said circuitry and specifications.