

**5A Low-Dropout Linear Regulator****Features**

- Available in 1.5V, 1.8V, 2.5V, 3.3V version
- TO-252, TO-263 and TO-263T package
- Internal short circuit current limiting
- Internal over temperature protection
- Output current 5A

Applications

- Post regulation for switching DC/DC converter
- High efficiency linear regulator
- Battery powered instrumentation
- Motherboard

General Description

The G1084-XX is a low dropout linear regulator with a dropout of 1.3V at 5A of load current. It is available in three fixed voltages: 1.5V, 1.8V, 2.5V and 3.3V. Refer to the G1084 for the adjustable version.

The G1084-XX provides over temperature and over current protection circuits to prevent it from being damaged by abnormal operating conditions.

The G1084-XX is available in TO-252, TO-263 and TO-263T packages. A minimum of 220 μ F tantalum electrolytic capacitor is required at the output to improve the transient response and stability.

Ordering Information

ORDER NUMBER	ORDER NUMBER (Pb free)	MARKING	TEMP. RANGE	PACKAGE	PIN OPTION		
					1	2	3
G1084-15T43U	G1084-15T43Uf	G1084-15	-40°C to +85°C	TO-252	GND	V _{OUT}	V _{IN}
G1084-18T43U	G1084-18T43Uf	G1084-18	-40°C to +85°C	TO-252	GND	V _{OUT}	V _{IN}
G1084-25T43U	G1084-25T43Uf	G1084-25	-40°C to +85°C	TO-252	GND	V _{OUT}	V _{IN}
G1084-33T43U	G1084-33T43Uf	G1084-33	-40°C to +85°C	TO-252	GND	V _{OUT}	V _{IN}
G1084-15T53U	G1084-15T53Uf	G1084-15	-40°C to +85°C	TO-263	GND	V _{OUT}	V _{IN}
G1084-18T53U	G1084-18T53Uf	G1084-18	-40°C to +85°C	TO-263	GND	V _{OUT}	V _{IN}
G1084-25T53U	G1084-25T53Uf	G1084-25	-40°C to +85°C	TO-263	GND	V _{OUT}	V _{IN}
G1084-33T53U	G1084-33T53Uf	G1084-33	-40°C to +85°C	TO-263	GND	V _{OUT}	V _{IN}
G1084-15TU3U	G1084-15TU3Uf	G1084-15	-40°C to +85°C	TO-263T	GND	V _{OUT}	V _{IN}
G1084-18TU3U	G1084-18TU3Uf	G1084-18	-40°C to +85°C	TO-263T	GND	V _{OUT}	V _{IN}
G1084-25TU3U	G1084-25TU3Uf	G1084-25	-40°C to +85°C	TO-263T	GND	V _{OUT}	V _{IN}
G1084-33TU3U	G1084-33TU3Uf	G1084-33	-40°C to +85°C	TO-263T	GND	V _{OUT}	V _{IN}

* For other package types and pin options, please contact us at sales@gmt.com.tw

Note: T4: TO-252 T5: TO-263 TU: TO-263T (thin)

3: Bonding Code

U: Tape & Reel

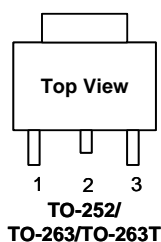
Package Type**Typical Application**

[Note 4]: Type of C_{OUT}

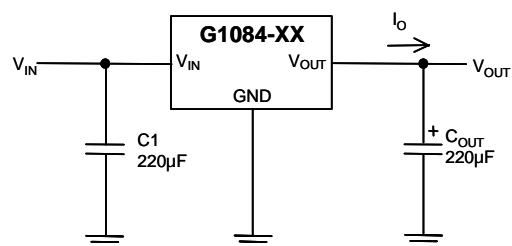

**Absolute Maximum Ratings** (Note 1)

Input Voltage	8V
Power Dissipation Internally Limited (Note 2)	
Maximum Junction Temperature	150°C
Storage Temperature Range	-65°C ≤ T _J ≤ +150°C
Reflow Temperature (soldering, 10sec)	260°C
Thermal Resistance Junction to Ambient	
TO-252 ⁽¹⁾	95°C/W
TO-263 ⁽¹⁾	80°C/W
TO-263T ⁽¹⁾	82°C/W
Thermal Resistance Junction to Case	
TO-252	8°C/W
TO-263	6°C/W
TO-263T	6°C/W
ESD Rating (Human Body Model)	.2kV

Operating Conditions (Note 1)

Input Voltage	.2.2V~7V
Temperature Range	-40°C ≤ T _A ≤ 85°C

Note ⁽¹⁾: See Recommended Minimum Footprint

Electrical Characteristics

V_{IN} = 5V, C_{IN} = C_{OUT} = 220μF, T_A = T_J = 25°C unless otherwise specified. (Note3)

PARAMETER	CONDITION	MIN	TYP	MAX	UNIT
Output Voltage	10mA ≤ I _{OUT} ≤ 5A	-2%	V _O	2%	V
Line Regulation	(V _{OUT} + 0.7V) ≤ V _{IN} ≤ 5.5V, I _{OUT} = 10mA	---	0.1	---	%
Load Regulation	G1084-18 V _{IN} = 3.8V, 10mA ≤ I _{OUT} ≤ 5A	---	1	---	%
	G1084-25 V _{IN} = 5V, 10mA ≤ I _{OUT} ≤ 5A	---			
	G1084-33 V _{IN} = 5V, 10mA ≤ I _{OUT} ≤ 5A	---			
Dropout Voltage	G1084-18 ΔV _{OUT} = 2%, I _{OUT} = 5A	---	1.6	---	V
	G1084-25 ΔV _{OUT} = 2%, I _{OUT} = 5A	---	1.3	---	
	G1084-33 ΔV _{OUT} = 2%, I _{OUT} = 5A	---	1.1	---	
Current Limit	(V _{IN} - V _{OUT}) = 2V	---	5.5	---	A
Short Circuit Current		---	1	---	A
Quiescent Current	G1084-18 V _{IN} = 5V	---	1.7	---	mA
	G1084-25 V _{IN} = 5V	---	2.1	---	
	G1084-33 V _{IN} = 5V	---	2.4	---	
Ripple Rejection	f = 120Hz, C _{OUT} = 10μF Tantalum, (V _{IN} - V _{OUT}) = 3V, I _{OUT} = 1A	---	50	---	dB
Thermal Shutdown	Junction Temperature	---	150	---	°C

Note 1: Absolute Maximum Ratings are limits beyond which damage to the device may occur. Operating Conditions are conditions under which the device functions but the specifications might not be guaranteed. For guaranteed specifications and test conditions see the Electrical Characteristics.

Note2: The maximum power dissipation is a function of the maximum junction temperature, T_{Jmax}; total thermal resistance, θ_{JA}, and ambient temperature T_A. The maximum allowable power dissipation at any ambient temperature is T_{Jmax}-T_A / θ_{JA}. If this dissipation is exceeded, the die temperature will rise above 150°C and IC will go into thermal shutdown.

Note3: Low duty pulse techniques are used during test to maintain junction temperature as close to ambient as possible.

Note4: The type of output capacitor should be tantalum or aluminum.

Definitions**Dropout Voltage**

The input/output Voltage differential at which the regulator output no longer maintains regulation against further reductions in input voltage. Measured when the output drops 2% below its nominal value. Dropout voltage is affected by junction temperature, load current and minimum input supply requirements.

Line Regulation

The change in output voltage for a change in input voltage. The measurement is made under conditions of low dissipation or by using pulse techniques such that average chip temperature is not significantly affected.

Load Regulation

The change in output voltage for a change in load current at constant chip temperature. The measurement is made under conditions of low dissipation or by using pulse techniques such that average chip temperature is not significantly affected.

Maximum Power Dissipation

The maximum total device dissipation for which the regulator will operate within specifications.

Quiescent Bias Current

Current which is used to operate the regulator chip and is not delivered to the load.



Typical Performance Characteristics

$V_{IN}-V_{OUT} = 3V$, $C_{IN} = 220\mu F$, $C_{OUT} = 220\mu F$, $T_A=25^\circ C$, unless otherwise noted.

Line Transient Response

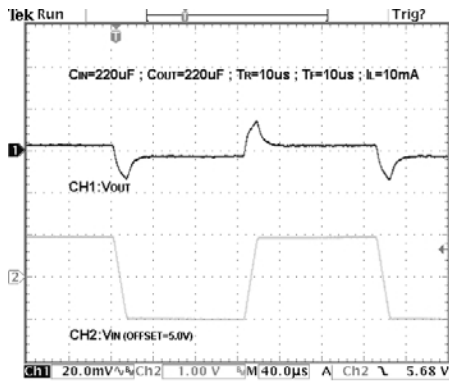

Load Transient Response

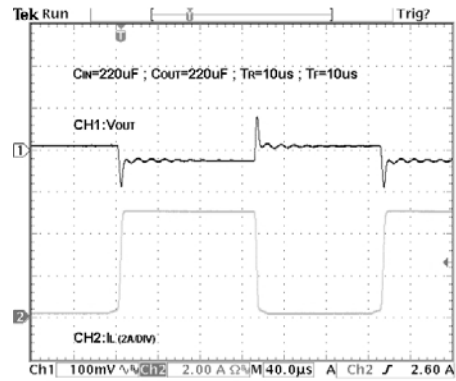

Short Circuit Current

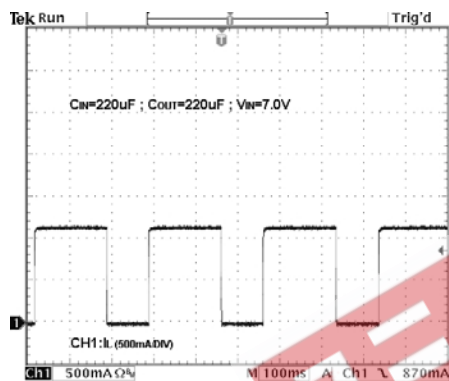

Ripple Rejection

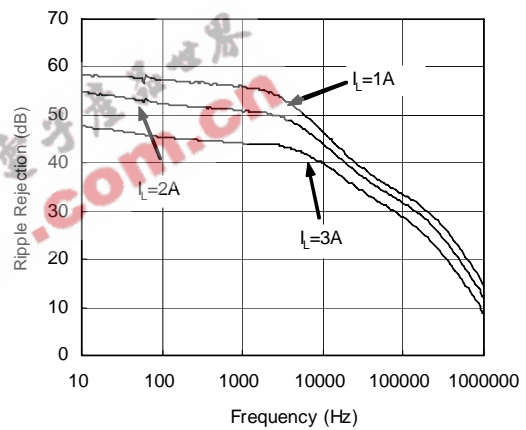

G1084-33 Overcurrent Protection Characteristics

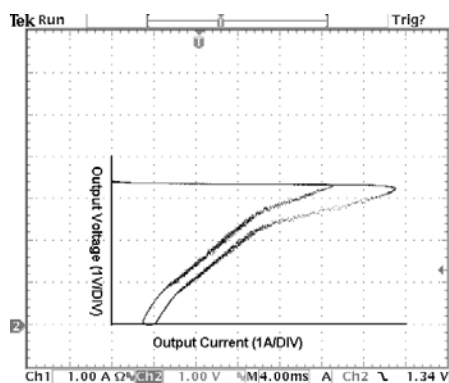

G1084 Start-up

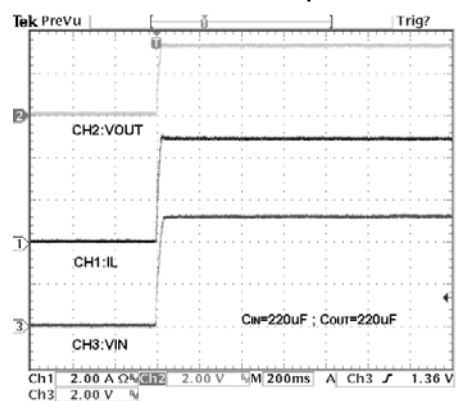



Typical Performance Characteristics (continued)

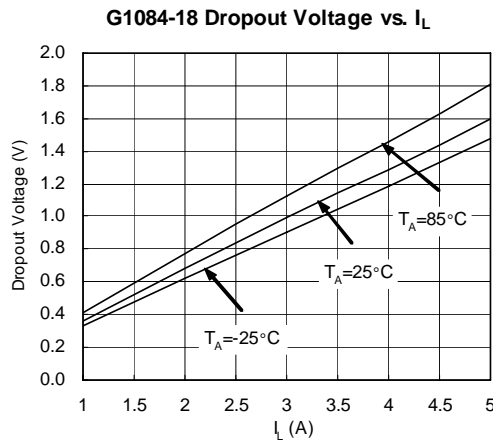
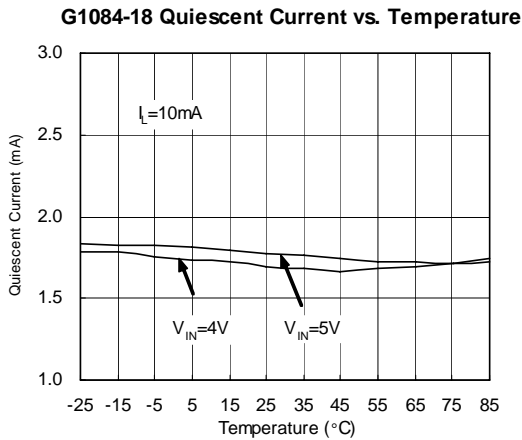
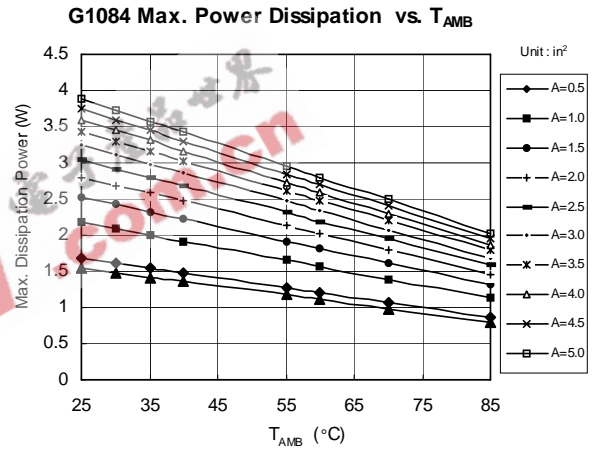
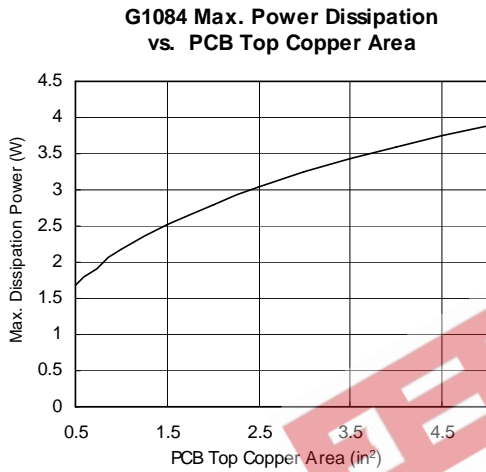
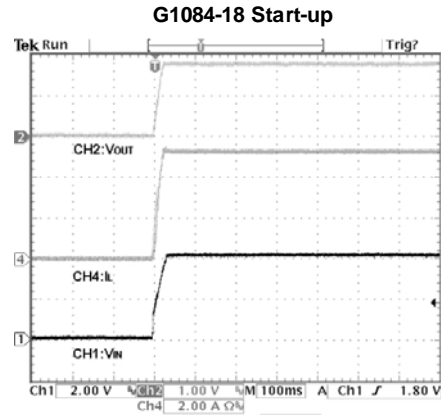
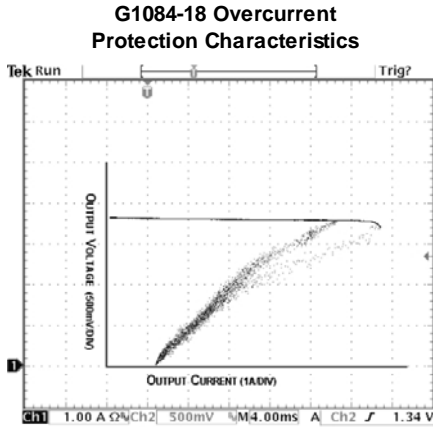



Typical Performance Characteristics (continued)

G1084-18 Output Voltage vs. Temperature

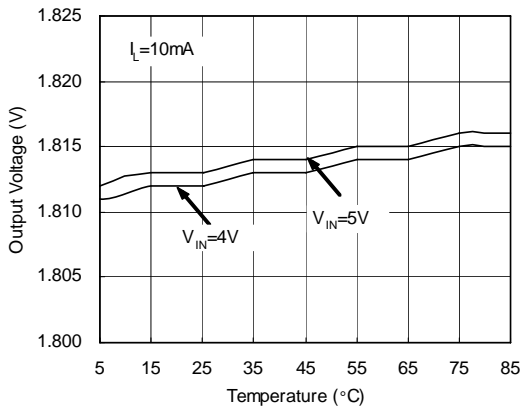

G1084-18 Output Voltage vs. I_L

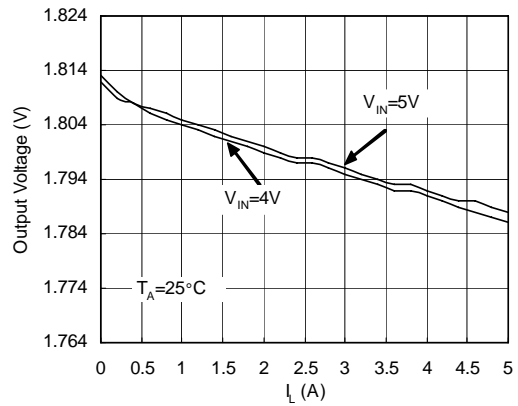

G1084-33 Quiescent Current vs. Temperature

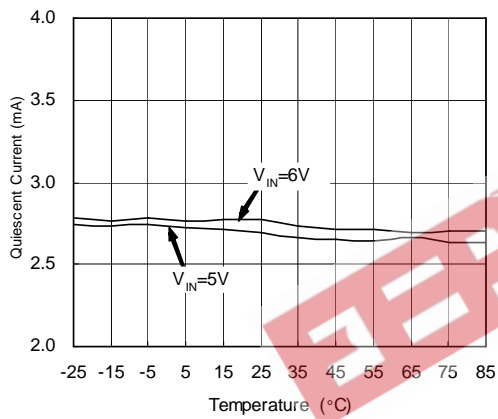

G1084-33 Dropout Voltage vs. I_L

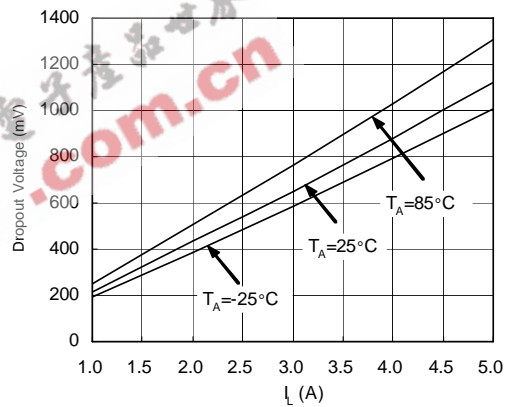

G1084-33 Output Voltage vs. Temperature

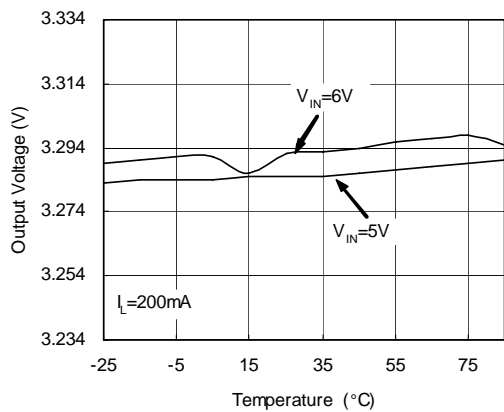

G1084-33 Output Voltage vs. I_L

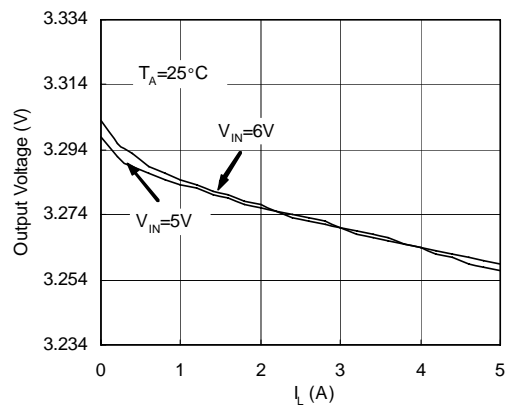

Typical Performance Characteristics (continued)

G1084-25 Quiescent Current vs. Temperature

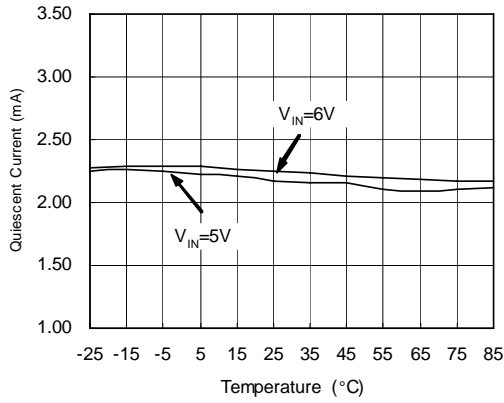

G1084-25 Dropout Voltage vs. IL

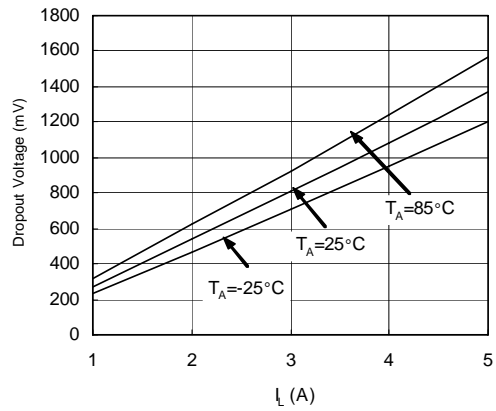

G1084-25-Output Voltage vs. Temperature

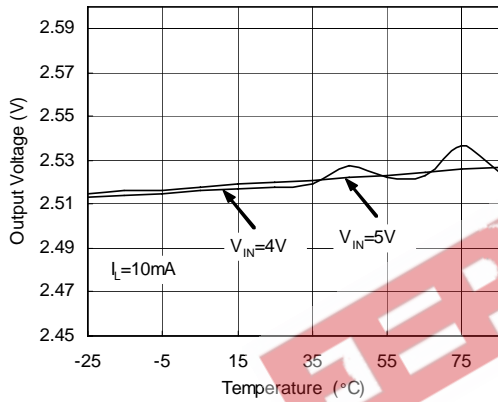

G1084-25 Output Voltage vs. IL

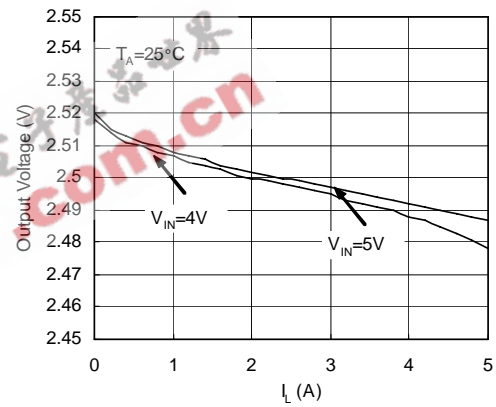

Recommend Minimum Footprint

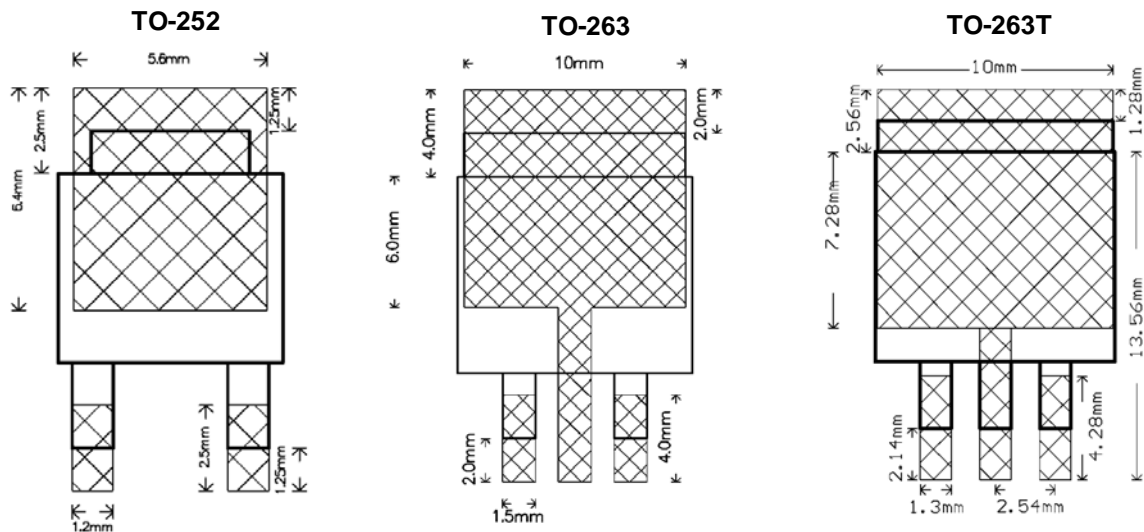



Package Information

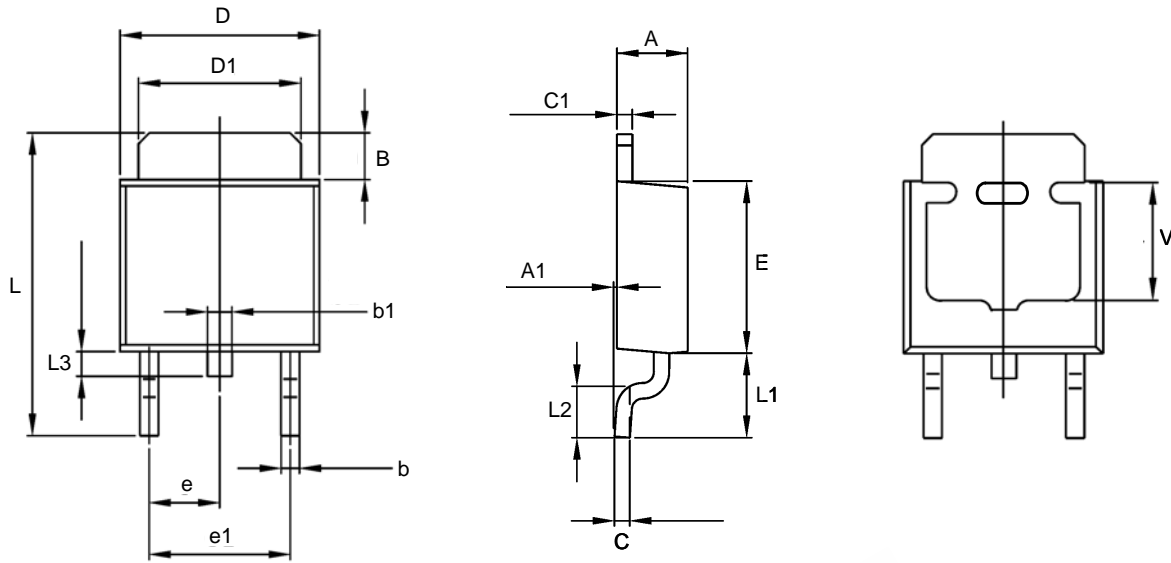

TO-252 (T4) Package

SYMBOL	MILLIMETERS		INCHES	
	MIN.	MAX.	MIN.	MAX.
A	2.190	2.400	0.086	0.094
A1	0.000	0.127	0.000	0.005
B	0.880	1.650	0.035	0.065
b	0.500	0.880	0.020	0.035
b1	0.700	0.900	0.028	0.035
C	0.430	0.580	0.017	0.023
C1	0.430	0.580	0.017	0.023
D	6.350	6.730	0.250	0.265
D1	5.200	5.460	0.205	0.215
E	5.400	6.220	0.213	0.245
e	2.300 TYP		0.091 TYP	
e1	4.500	4.700	0.177	0.185
L	8.830	10.77	0.348	0.424
L1	2.550	2.900	0.100	0.114
L2	1.400	1.780	0.055	0.070
L3	0.350	1.020	0.014	0.040
V	3.800	4.320	0.150	0.170

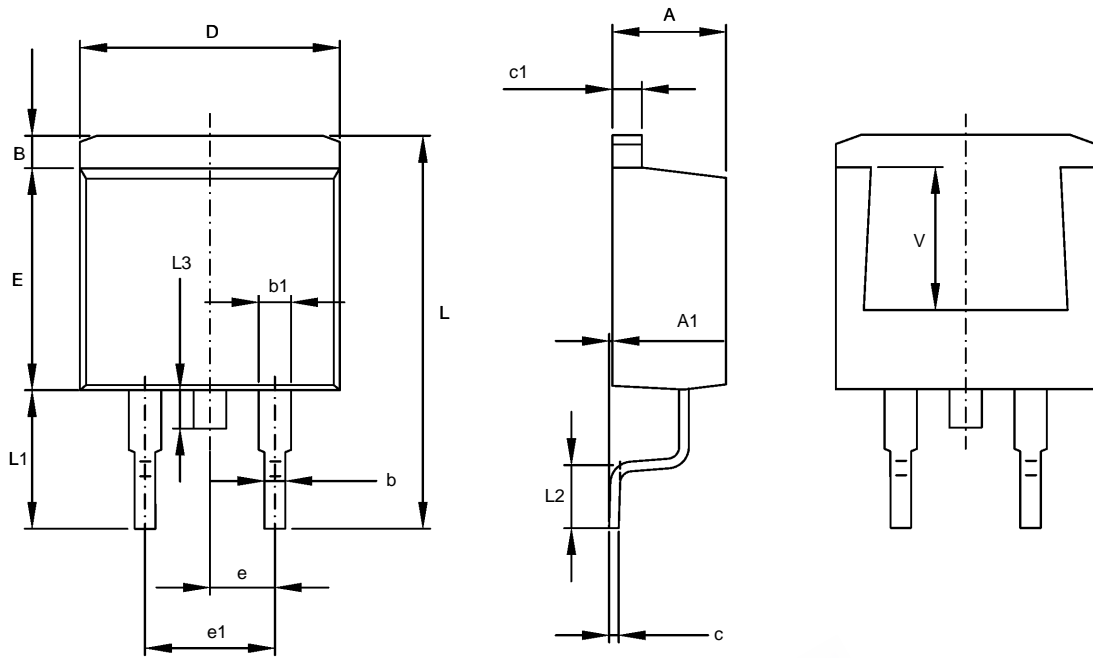

TO-263 (T5) Package

SYMBOL	MILLIMETER		INCH	
	MIN	MAX	MIN	MAX
A	4.470	4.670	0.176	0.184
A1	0.000	0.150	0.000	0.006
B	1.170	1.370	0.046	0.054
b	0.710	0.910	0.028	0.036
b1	1.170	1.370	0.046	0.054
c	0.310	0.530	0.012	0.021
c1	1.170	1.370	0.046	0.054
D	10.010	10.310	0.394	0.406
E	8.500	8.900	0.335	0.350
e	2.540 TYP		0.100 TYP	
e1	4.980	5.180	0.196	0.204
L	15.050	15.450	0.593	0.608
L1	5.080	5.480	0.200	0.216
L2	2.340	2.740	0.092	0.108
L3	1.300	1.700	0.051	0.067
V	5.600 REF		0.220 REF	

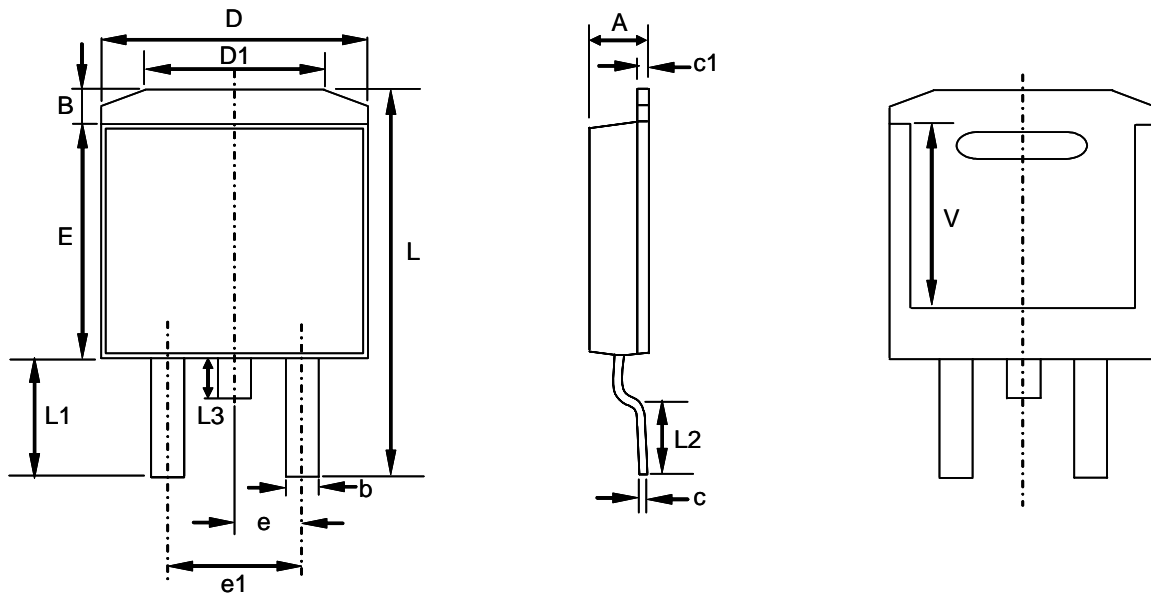

TO-263T (TU) Package

SYMBOL	DIMENSIONS IN MILLIMETER			DIMENSIONS IN INCH		
	MIN	NOM	MAX	MIN	NOM	MAX
A	1.750	2.000	2.250	0.069	0.079	0.089
B	0.880	1.280	1.680	0.345	0.050	0.066
b	1.255	1.295	1.335	0.049	0.051	0.053
c	0.381	0.406	0.431	0.015	0.016	0.017
c1	0.356	0.406	0.456	0.014	0.016	0.018
D	9.660	10.160	10.660	0.380	0.400	0.420
D1	6.900 REF			0.272 REF		
E	8.380	8.680	8.980	0.330	0.342	0.354
e	-----	2.540	-----	-----	0.100	-----
e1	-----	5.080	-----	-----	0.200	-----
L	13.74	14.240	14.740	0.541	0.561	0.580
L1	-----	4.280	-----	-----	0.169	-----
L2	2.290	2.540	2.790	0.090	0.100	0.110
L3	-----	-----	1.778	-----	-----	0.070
V	-----	7.280	-----	-----	0.287	-----

Taping Specification

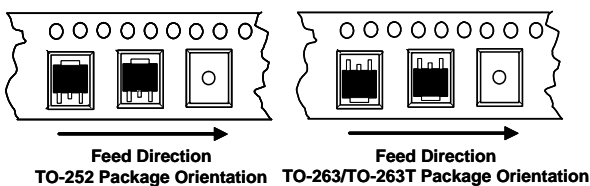

PACKAGE	Q'TY/REEL
TO-252	2,500 ea
TO-263	800 ea
TO-263T	1,500 ea

GMT Inc. does not assume any responsibility for use of any circuitry described, no circuit patent licenses are implied and GMT Inc. reserves the right at any time without notice to change said circuitry and specifications.