

**Ultra160 Multi-mode LVD/SE SCSI Terminator****Features**

- Auto-selectable multi-mode Single-Ended or LVD Termination
- Meets SCSI-1, SCSI-2, SCSI-3 SPI Ultra (Fast-20), Ultra 2(SPI-2 LVD), Ultra160 (SPI-3 LVD) standards.
- Supports active negation
- 3pF channel capacitance
- Thermal protection
- Hot-Swap compatible
- 5% tolerance on SE and LVD termination resistance
- 28 and 36 pin SSOP package
- 28 Pin SSOP: Pin Compatible with DS2119
- 36 Pin SSOP: Pin Compatible with DS2118, LX5241 and UCC5630

Applications

- Server and workstation
- High-end PC
- Industrial PC
- Disk Array (RAID)
- SCSI cable

General Description

The G218B Multi-mode LVD/SE SCSI terminator provides a smooth transition into the next generation of the SCSI Parallel Interface (SPI-3). It automatically senses the bus, via DIFFSENS, and switches the termination to either single-ended (SE) or low voltage differential (LVD) SCSI, dependent on which type of devices are connected to the bus. If the G218B detects a HVD SCSI device, it switches to a high impedance state. For a 16-bit Wide SCSI bus to be operational, three G218B terminators are needed.

The Multi-mode terminator contains all functions required to terminate and auto detect and switch modes for SCSI Parallel Interface (SPI) bus architectures. For the SE termination, one regulator and nine precision 110ohm resistors are used. For the LVD termination, the G218B integrates 18 regulated supplies with nine precision resistor strings.

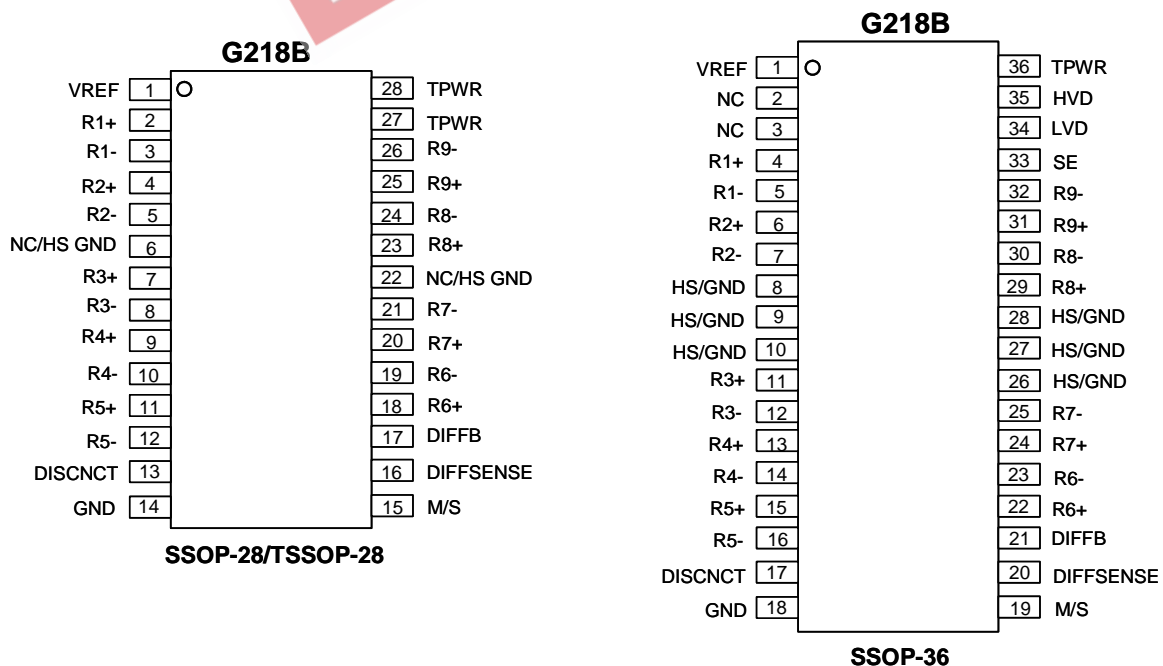
Pin Configuration



Ordering Information

ORDER NUMBER	ORDER NUMBER (Pb free)	TEMP. RANGE	PACKAGE	FEATURE
G218BT-S4	G218BT-S4f	0°C-70°C	SSOP-28 / Tube	DISCNCT does not disable VREF
G218BR-S4	G218BR-S4f	0°C-70°C	SSOP-28 / Tape & Reel	DISCNCT does not disable VREF
G218BT-S5	G218BT-S5f	0°C-70°C	SSOP-36 / Tube	DISCNCT does not disable VREF
G218BR-S5	G218BR-S5f	0°C-70°C	SSOP-36 / Tape & Reel	DISCNCT does not disable VREF
G218BT-D3	G218BT-D3f	0°C-70°C	TSSOP-28 / Tube	DISCNCT does not disable VREF
G218BR-D3	G218BR-D3f	0°C-70°C	TSSOP-28 / Tape & Reel	DISCNCT does not disable VREF

Note:

DIFFSENS—Refers to the SCSI bus signal.

DIFFSENSE—Refers to the G218B pin name and internal circuitry relating to differential sensing.

DIFFFB—Refers to the G218B pin name and internal circuitry relating to monitoring the DIFFSENS line.

Functional Description

The G218B is used in multi-mode active termination applications, where single ended (SE) and low voltage differential (LVD) devices might coexist. The LVD termination section consists of 18 source/sink amplifiers (VTOP, VBOT), biasing circuitry and nine precision resistor strings (RTOP, RMID, RBOT). The SE termination section consists of a 2.85V source/sink regulator with 9 precision 110ohm resistor. The DIFFSENSE section consists of a 1.3V, 5mA driver and a sensing circuit (Figure 1)

DIFFSENS is used to identify which types of SCSI devices are present on the bus. If the voltage on DIFFSENS is between 0-0.5V the bus is single-ended; if it is between 0.7-1.9V the bus is LVD; and if it is greater than 2.4V, the bus is HVD.

The G218B DIFFFB pin monitors the DIFFSENS line to determine the proper operating mode of the device; this mode is indicated by the SE/LVD/HVD outputs.

HVD Isolation Mode The G218B identifies that there is an HVD (high voltage differential) device on the SCSI bus and isolates the termination pins from the bus.

When DISCNCT is pulled high, the termination pins are isolated from the SCSI bus, and the bus mode indicators (SE/LVD/HVD) as well as VREF remains active. During thermal shutdown, the termination pins are isolated from the SCSI bus and VREF becomes high impedance. The DIFFSENSE driver is shut down during either of these two events.

To ensure proper operation, the TPWR pin should be connected to the SCSI bus TERMPWR line. As with all analog circuitry, the TERMPWR lines should be bypassed locally. A 2.2µF capacitor and a 0.01µF high frequency capacitor is recommended between TPWR

and ground and placed as close as possible to the G218B. The G218B should be placed as close as possible to the SCSI connector to minimize signal and power trace length, thereby resulting in less input capacitance and reflections which can degrade the bus signals.

The DIFFSENSE pin can drive the SCSI DIFFSENS line (when M/S is pulled high) to determine the SCSI bus operating mode. The G218B switches to the termination mode that is appropriate for the bus based on the value of the DIFFSENS voltage. These modes are:

LVD mode LVD termination is provided by a precision resistor string with two amplifiers. This configuration yields a 105Ω differential and 150Ω common mode impedance. A fail safe bias of 112mV is maintained when no drivers are connected to the SCSI bus.

SE mode When the external driver for a given signal line turns off, the active terminator will pull that signal line to 2.85 volts (quiescent state). When used with an active negation driver, the power amp can sink 22mA per line while keeping the voltage reference in regulation. The terminating resistors maintain their 110Ω value.

To maintain the specified regulation, a 4.7µF capacitor is required between the VREF pin and ground of each G218B. A high frequency cap (0.1µF ceramic recommended) can also be placed on the VREF pin in applications that use fast rise/fall time drivers. A typical SCSI bus configuration is shown in Figure2.

An internal pull down resistor assures that the G218B will be terminating the bus if the DISCNCT pin is left floating.

Block Diagram (Figure 1)

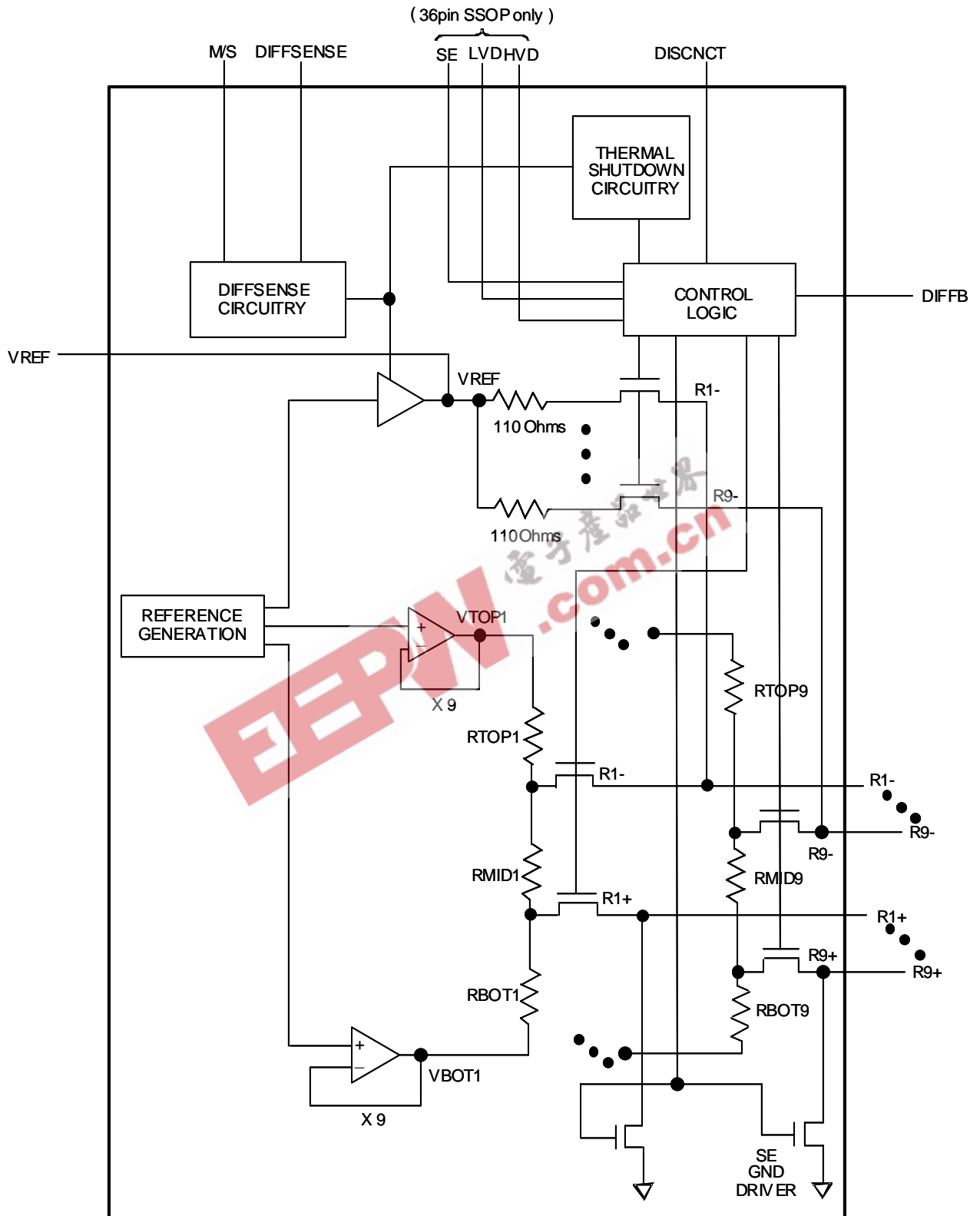

SCSI Bus Configuration (Figure 2)

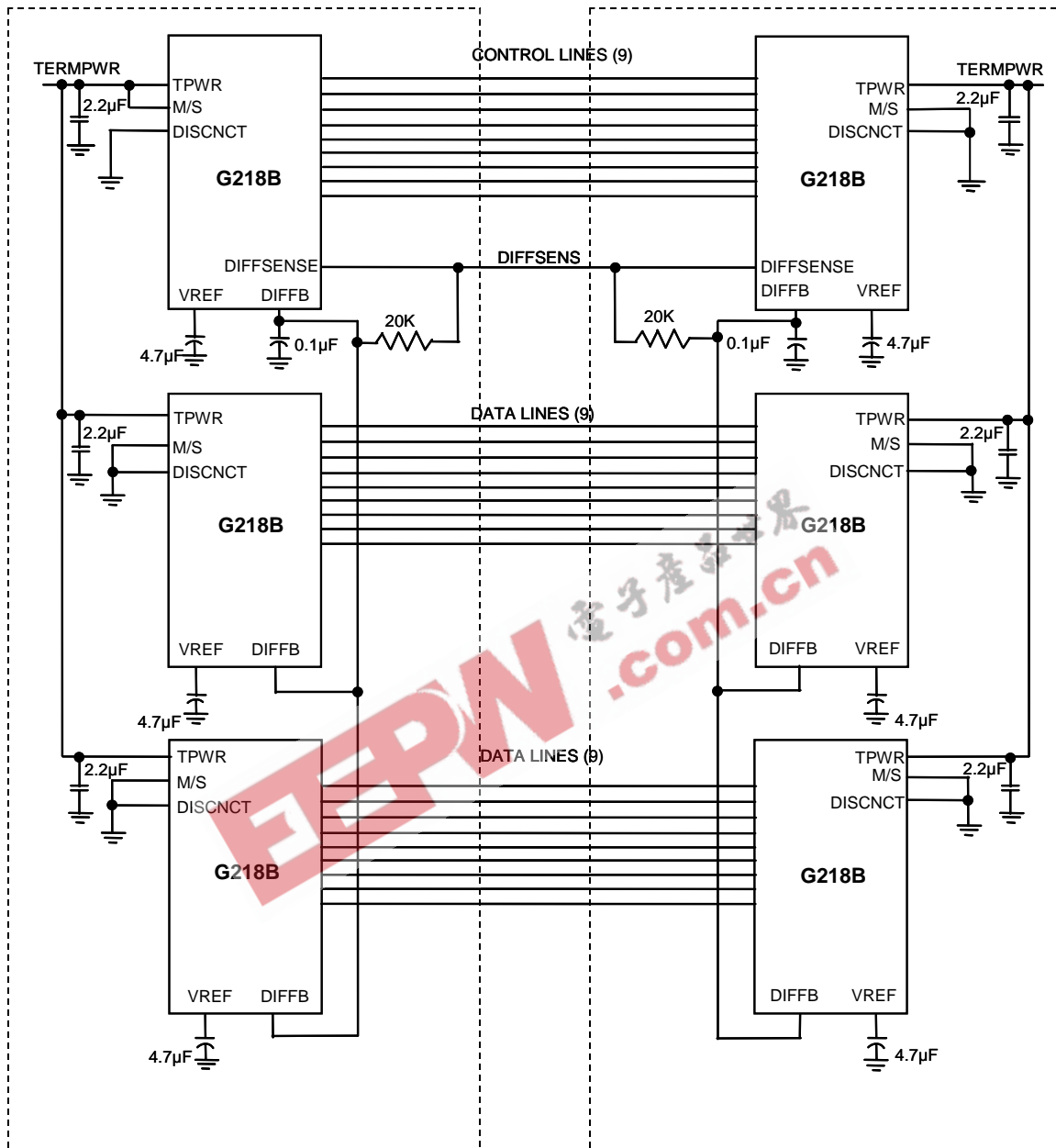



Recommended Operating Conditions

PARAMETER	SYMBOL	MIN	TYP	MAX	UNITS
Tempower Voltage	$V_{tpwr} (SE)$	4.0	5	5.5	V
	$V_{tpwr} (LVD)$	2.9	5	5.5	
Logic 0	V_{il}	-0.3	---	+0.8	V
Logic 1	V_{ih}	2.0	---	$V_{tpwr}+0.3$	V
Operating Temperature	T_{amb}	0	---	70	°C

Electrical Characteristics

Unless otherwise specified, these specifications apply over the operating ambient temperature range of $0^{\circ}\text{C} \leq T_A \leq 70^{\circ}\text{C}$.

PARAMETER	SYMBOL	Condition	MIN	TYP	MAX	UNITS
LVD Terminator Section						
Differential Mode Termination Resistance	Rdm		100	105	110	Ohms
Common Mode Termination Resistance	Rcm		110	150	190	Ohms
Differential Mode Bias	Vdm	All lines Open	100	112	125	mV
Common Mode Bias	Vcm		1.125	1.25	1.375	V
Single Ended Terminator Section						
Output Capacitance	Cout	Note			3	pF
SE Termination Resistance	Rse	Vline = 0-3.0 volts	104.5	110	115.5	Ohms
SE Voltage Reference	Vref		2.79	2.85	2.93	Volts
SE output Current	Iose	Vline = 0.2 volts			25.4	mA
Regulator Section						
Line Regulation	L _{REG}			1.0	2.5	%
Load Regulation	L _{OREG}			1.3	3.5	%
Current Limit	I _{LIM}			350		mA
Sink Current	I _{SINK}		200			mA
DC Section						
Tempower Current	I _{tpmr}	SE mode (No Load)		4		mA
		LVD mode (No Load)		20		
Input Leakage High	I _{ih}		-1.0			μA
Input Leakage Low	I _{il}				1.0	μA
Output Current High	I _{oh}	V _{out} = 2.4 volts; SE/LVD/HVD Pins only	-1.0			mA
Output Current Low	I _{ol}	V _{out} = 0.4 volts; SE/LVD/HVD Pins only	4.0			mA
DIFFSENS Section						
DIFFSENS SE Operating Range	V _{seor}		-0.3		0.5	V
DIFFSENS LVD Operating Range	V _{lvdor}		0.7		1.9	V
DIFFSENS HVD Operating Range	V _{hvdor}		2.4		$V_{tpwr}+0.3$	V
DIFFSENSE Driver Output Voltage	V _{dso}	M/S=1; I _{ds} = 0-5mA	1.2		1.4	V
DIFFSENSE Driver Source Current	I _{dsh}	M/S = 1; V _{dso} =0V		5	15	mA
DIFFSENSE Driver Sink Current	I _{dsl}	M/S=1; V _{dso} =2.75V	20		200	μA

Note: Guaranteed by Design.



Typical Operating Characteristics

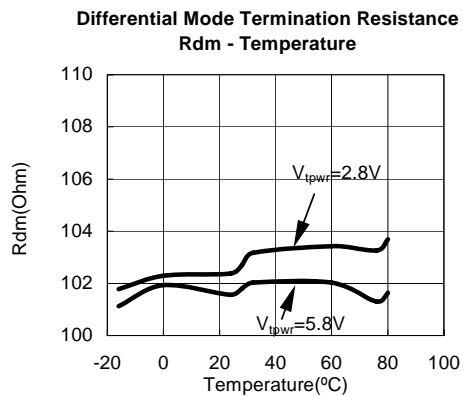
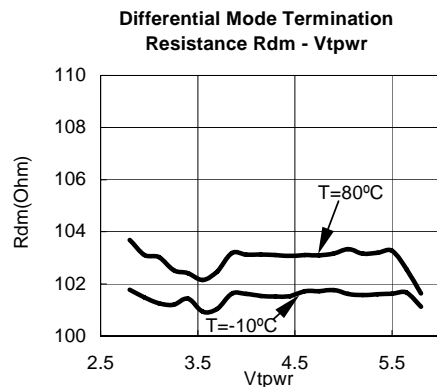
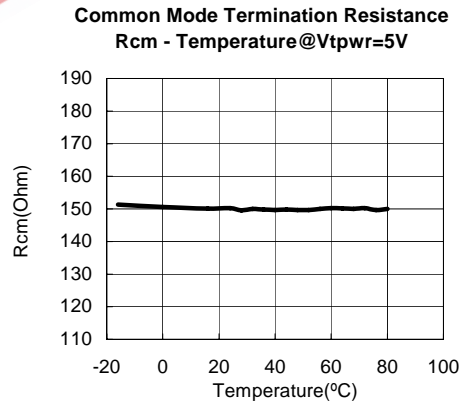
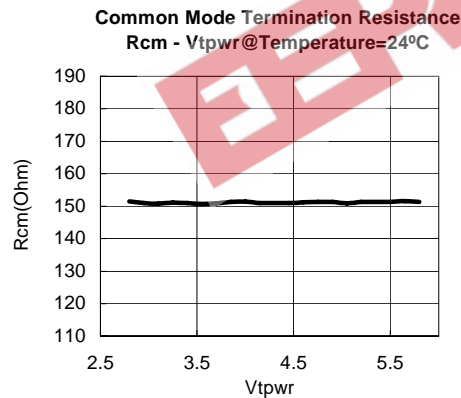
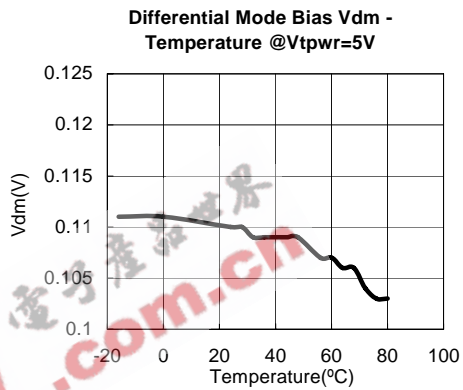
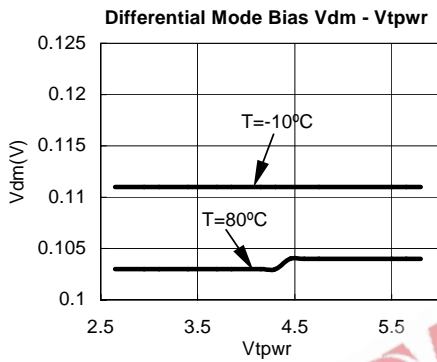
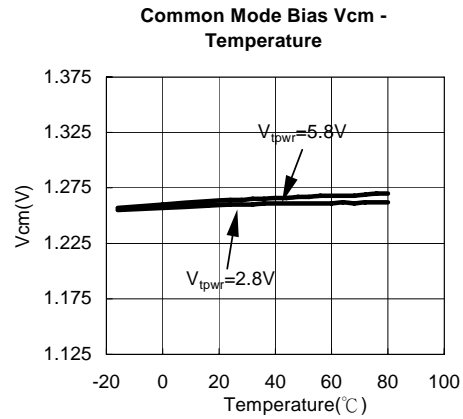
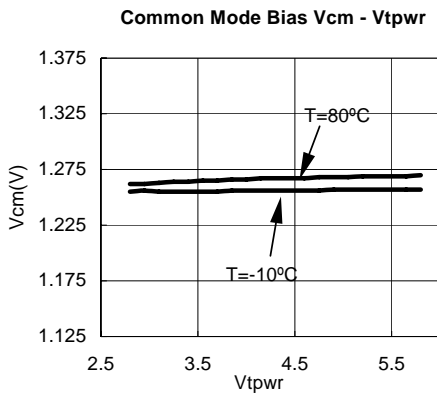

SE Termination Resistance Rse - Vtpwr
@T=24°C;Vline=0V

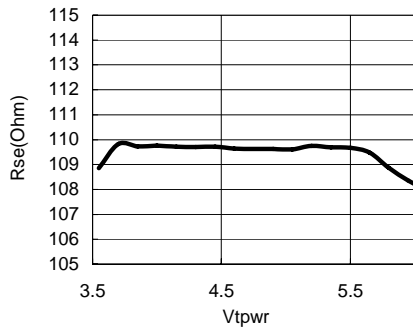

SE Termination Resistance Rse - Vtpwr
@Vline=0V

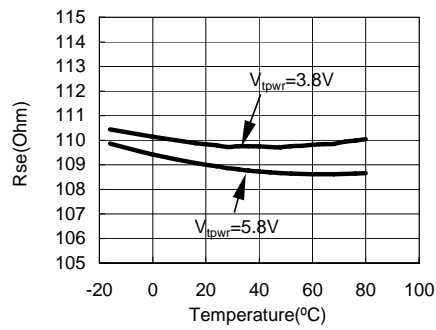

SE Termination Resistance Rse - Vtpwr
@Vtpwr=5V;T=24°C

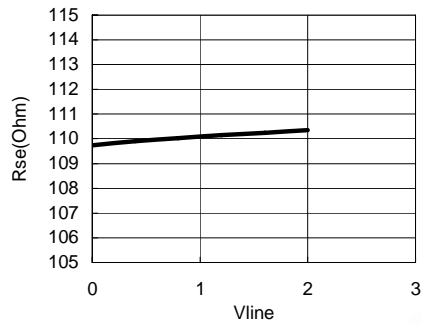

Vref - Ivref@Vtpwr=5V;T=24°C

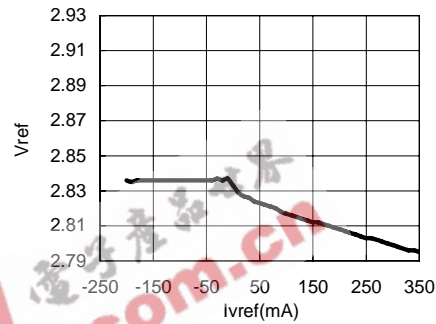

Vref - Temperature@Ivref=0mA

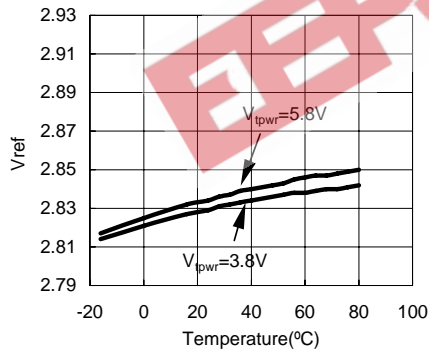

Vref - Vtpwr@T=24°C

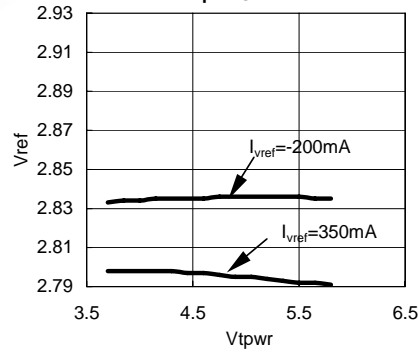



Pin Description (for 28pin SSOP/TSSOP)

PIN	SYMBOL	DESCRIPTION
1	VREF*	Reference Voltage. 2.85-volt reference; must be connected to a 4.7 μ F capacitor.
2-5,7-12, 18-21, 23-26	Rx+, Rx-	Signal Termination. (X=1,2,3,.....9) Rx+: Ground line for single-ended or positive line for differential applications for the SCSI bus. Rx-: Signal line/active line for single-ended or negative line in differential applications for the SCSI bus.
6,22	NC/ HS GND	No Connect/ HS GND. Should be grounded for heat sinking purpose.
13	DISCNCT	Disconnect. When pulled high, the G218B isolates its bus pins (Rx+, Rx-) from the SCSI bus.
14	GND	Ground. Terminator ground pin. Connected to ground.
15	M/S	Master/slave. Used to select which terminator is the controlling device. M/S pin high enables the DIFFSENSE driver.
16	DIFFSENSE	Output to drive the SCSI bus DIFFSENS line.
17	DIFFB	DIFFB pin should be connected to a 0.1 μ F capacitor to GND and 20k resistor to SCSI/Bus DIFFSENS line. An input pin to detect the type of device (differential or single-ended) on the SCSI bus.
27,28	TPWR	Terminator Power. Connect to the SCSI TERMPWR line and de-couple with a 2.2 μ F capacitor.

*The VREF keeps the level at 2.85 volt, despite the DISCNCT pin is asserted or not; even the termination mode is changed.

(36pin SSOP)

PIN	SYMBOL	DESCRIPTION
1	VREF*	Reference Voltage. 2.85-volt reference; must be connected to a 4.7 μ F capacitor.
2,3	NC	No Connect. Do not connect these pins.
4-7,11-16, 22-25, 29-32	Rx+ Rx-	Signal Termination. (X=1,2,3,.....9) Rx+: Ground line for single-ended or positive line for differential applications for the SCSI bus. Rx-: Signal line/active line for single-ended or negative line in differential applications for the SCSI bus.
8, 9,10,26, 27,28	HS/GND	Heat Sink Ground. Connect to large area PC board traces to increase power dissipation capability.
17	DISCNCT	Disconnect. When pulled high, the G218 isolates its bus pins (Rx+, Rx-) from the SCSI bus.
18	GND	Ground. Terminator ground pin. Connected to ground.
19	M/S	Master/slave. Used to select which terminator is the controlling device. M/S pin high enables the DIFFSENSE driver.
20	DIFFSENSE	Output to drive the SCSI bus DIFFSENS line.
21	DIFFB	DIFFB pin should be connected to a 0.1 μ F capacitor to GND and 20k resistor to SCSI/Bus DIFFSENS line. An input pin to detect the type of device (differential or single-ended) on the SCSI bus.
33	SE	Single ended mode indicator. It is HIGH when terminator is operating in SE mode.
34	LVD	Low Voltage Differential mode indicator. It is HIGH when terminator is operating in LVD mode.
35	HVD	High Voltage Differential mode indicator. It is HIGH when terminator is operating in HVD mode.
36	TPWR	Terminator Power. Connect to SCSI bus TERMPWR line and decouple with 2.2 μ F capacitor.

*The VREF keeps the level at 2.85 volt, despite the DISCNCT pin is asserted or not; even the termination mode is changed.

Package Information

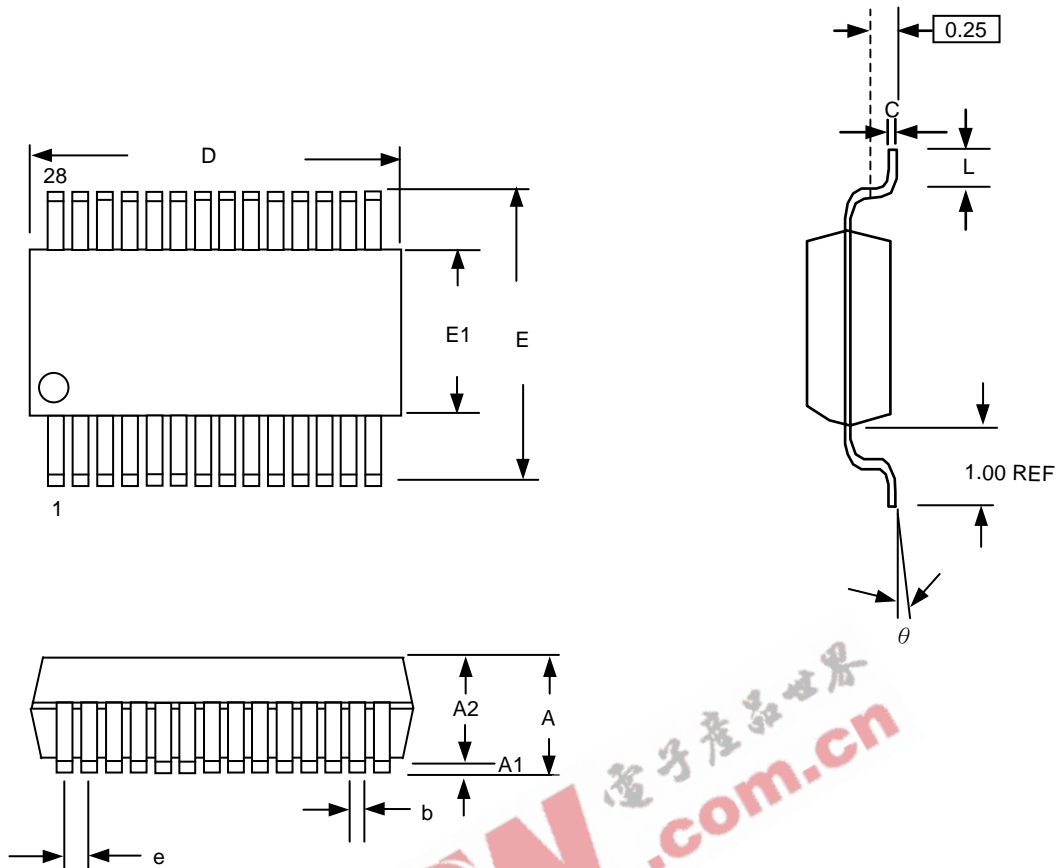

SSOP-28 Package

SYMBOL	DIMENSION IN MM			DIMENSION IN INCH		
	MIN.	TYP.	MAX.	MIN.	TYP.	MAX.
A	1.35	1.60	1.75	0.053	0.064	0.069
A1	0.10	-----	0.25	0.004	-----	0.010
A2	-----	1.45	-----	-----	0.057	-----
b	0.20	0.25	0.30	0.008	0.010	0.012
C	0.19	-----	0.25	0.007	-----	0.010
D	9.80	-----	10.00	0.386	-----	0.394
E	5.80	-----	6.20	0.228	-----	0.244
E1	3.80	-----	4.00	0.150	-----	0.157
e	-----	0.64	-----	-----	0.025	-----
L	0.40	-----	1.27	0.016	-----	0.050
y	-----	-----	0.10	-----	-----	0.004
θ	0°	-----	8°	0°	-----	8°

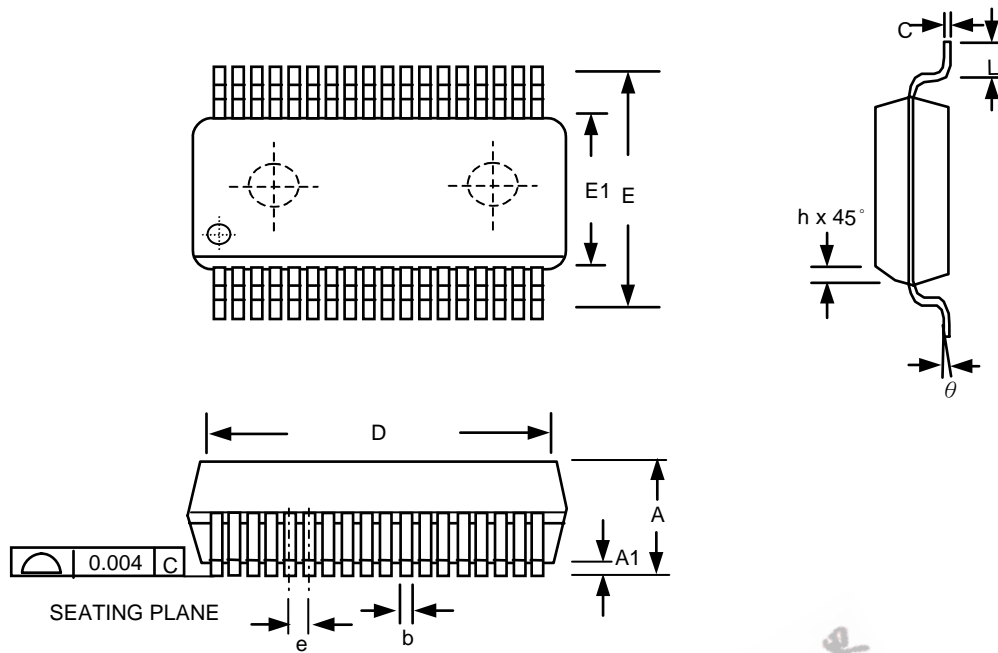

SSOP-36 Package

Symbol	Dimension in mm			Dimension in inch		
	MIN.	TYP.	MAX.	MIN.	TYP.	MAX.
A	2.413	2.591	2.794	0.095	0.102	0.110
A1	0.203	0.305	0.406	0.008	0.012	0.016
b	0.300	----	0.450	0.012	----	0.018
c	0.127	----	0.254	0.005	----	0.010
D	15.748	15.875	16.002	0.620	0.625	0.630
e	0.800 BASIC			0.032 BASIC		
E	10.033	----	10.668	0.395	----	0.420
E1	7.391	7.493	7.595	0.291	0.295	0.289
h	0.381	----	0.635	0.015	----	0.025
L	0.508	----	1.016	0.020	----	0.040
θ	0	----	8	0	----	8

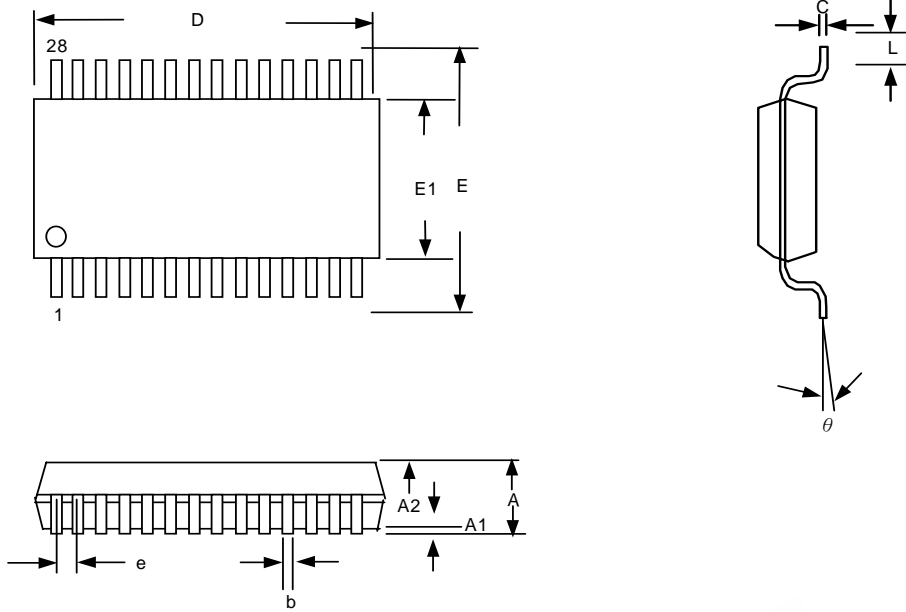

TSSOP-28 Package

NOTE:

1. Package body sizes exclude mold flash protrusions or gate burrs
2. Tolerance $\pm 0.1\text{mm}$ unless otherwise specified
3. Coplanarity : 0.1mm
4. Controlling dimension is in millimeter. Converted inch dimensions are not necessarily accurate.
5. Follow JEDEC MO-153

SYMBOL	DIMENSION IN MM			DIMENSION IN INCH		
	MIN.	NOM.	MAX.	MIN.	NOM.	MAX.
A	----	----	1.20	----	----	0.048
A1	0.05	----	0.15	0.002	----	0.006
A2	0.80	1.00	1.05	0.031	0.039	0.041
b	0.19	----	0.30	0.007	----	0.012
C	0.09	----	0.20	0.004	----	0.008
D	9.60	9.70	9.80	0.378	0.382	0.386
E	----	6.40	----	----	0.252	----
E1	4.30	4.40	4.50	0.169	0.173	0.177
e	----	0.65	----	----	0.026	----
L	0.45	0.60	0.75	0.018	0.024	0.030
y	----	----	0.10	----	----	0.004
θ	0°	----	8°	0°	----	8°

Taping Specification

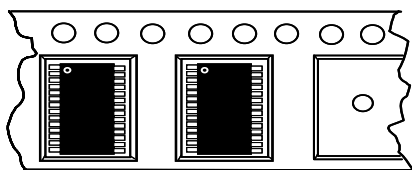

Typical SSOP, TSSOP Package Orientation

PACKAGE	Q'TY/REEL	Q'TY/TUBE
SSOP-28	2,500 ea	50 ea
SSOP-36	1,000 ea	29 ea
TSSOP-28	2,500 ea	50 ea

GMT Inc. does not assume any responsibility for use of any circuitry described, no circuit patent licenses are implied and GMT Inc. reserves the right at any time without notice to change said circuitry and specifications.