

**5A Adjustable Low-Dropout Linear Regulator****Features**

- Available in Adjust Version
- TO-220, TO-252, TO-263 and TO-263T Package
- Internal Short Circuit Current Limiting
- Internal Over Temperature Protection
- Output Current 5A

Applications

- Post Regulation for Switching DC/DC Converter
- High Efficiency Linear Regulator
- Battery Charger
- Battery Powered Instrumentation
- Motherboard

General Description

The G1084 is a low dropout linear regulator with a dropout of 1.2V at 5A of load current. It is available in an adjustable version, which can set the output from 1.25V to 5V with only two external resistors.

The G1084 provides over temperature and over current protection circuits to prevent it from being damaged by abnormal operating conditions.

The G1084 is available in TO-220, TO-252, TO-263 and TO-263T packages. A minimum of 220 μ F tantalum electrolytic capacitor is required at the output to improve the transient response and stability.

Ordering Information

ORDER NUMBER	ORDER NUMBER (Pb free)	MARKING	TEMP. RANGE	PACKAGE	PIN OPTION		
					1	2	3
G1084T33T	G1084T33Tf	G1084	-40°C to +85°C	TO-220	GND/ADJ	V _{OUT}	V _{IN}
G1084T43U	G1084T43Uf	G1084	-40°C to +85°C	TO-252	GND/ADJ	V _{OUT}	V _{IN}
G1084T53U	G1084T53Uf	G1084	-40°C to +85°C	TO-263	GND/ADJ	V _{OUT}	V _{IN}
G1084TU3U	G1084TU3Uf	G1084	-40°C to +85°C	TO-263T	GND/ADJ	V _{OUT}	V _{IN}

* For other package types and pin options, please contact us at sales@gmt.com.tw

Note: T3: TO-220 T4: TO-252 T5: TO-263 TU: TO-263T (thin)

3: Bonding Code

U: Tape & Reel T: Tube

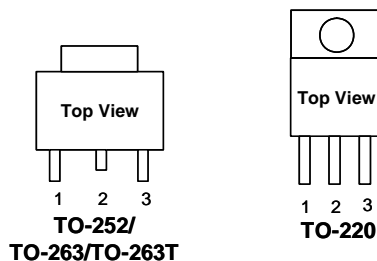
Package Type**Typical Application**

[Note 4]: Type of C_{OUT}

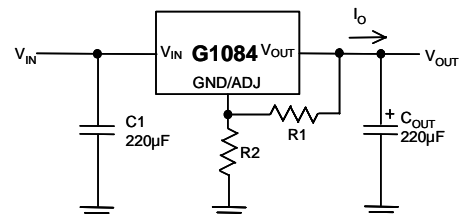

**Absolute Maximum Ratings** (Note 1)

Input Voltage	7V
Power Dissipation Internally Limited	(Note 2)
Maximum Junction Temperature	150°C
Storage Temperature Range	-65°C ≤ T _J ≤ +150°C
Reflow Temperature (soldering, 10sec)	260°C
Thermal Resistance Junction to Ambient, (θ _{JA})	
TO-252 ⁽¹⁾	85°C/W
TO-263 ⁽¹⁾	70°C/W
TO-263T ⁽¹⁾	73°C/W
TO-220 No Heatsink	53°C/W
TO-220 with Infinite Heatsink ⁽²⁾	23°C/W
Thermal Resistance Junction to Case, (θ _{JC})	
TO-220	5°C/W
TO-252	8°C/W
TO-263	5°C/W
TO-263T	5°C/W
ESD Rating (Human Body Model)	2kV

Operating Conditions (Note 1)

(V _{IN} -V _{ADJ}) Voltage	2.5V~5.5V
Temperature Range	-40°C ≤ T _A ≤ 85°C

Note ⁽¹⁾: See Recommended Minimum Footprint

Note ⁽²⁾: Refer to heatsink package dimension.

Electrical Characteristics

Operating Conditions: V_{IN} ≤ 5.5V, T_A = T_J = 25°C unless otherwise specified. [Note3]

PARAMETER	CONDITION	MIN	TYP	MAX	UNIT
Reference Voltage	V _{IN} - V _{OUT} = 2V, I _{OUT} = 10mA	1.225	1.250	1.275	V
Line Regulation	(V _{OUT} + 1.5V) ≤ V _{IN} ≤ 5.5V, I _{OUT} = 10mA	---	0.5	1	%
Load Regulation	(V _{IN} - V _{OUT}) = 2V, 10mA ≤ I _{OUT} ≤ 5A	---	0.04	0.5	%
Dropout Voltage	ΔV _{OUT} = 2%, I _{OUT} = 5A	---	1.3	1.5	V
Current Limit	(V _{IN} - V _{OUT}) = 2V	---	5.4	---	A
Adjust Pin Current Change	V _{IN} - V _{OUT} = 2V, 10mA ≤ I _{OUT} ≤ 5A	---	0.15	---	μA
Minimum Load Current	1.5V ≤ (V _{IN} - V _{OUT}) ≤ 5.25V	10	---	---	mA
Quiescent Current	V _{IN} - V _{OUT} = 2V	---	80	150	μA
Ripple Rejection	f = 120Hz, C _{OUT} = 10μF Tantalum, (V _{IN} - V _{OUT}) = 3V, I _{OUT} = 1A	---	45	---	dB
Temperature Stability	V _{IN} = 4V, I _O = 10mA	---	0.3	---	%
RMS Output Noise (% of V _{OUT})	T _A = 25°C, 10Hz ≤ f ≤ 10kHz, I _{LOAD} = 10mA	---	0.007	---	%
Thermal Shutdown	Junction Temperature	---	150	---	°C
Thermal Shutdown Hysteresis		---	30	---	°C

Note 1: Absolute Maximum Ratings are limits beyond which damage to the device may occur. Operating Conditions are conditions under which the device functions but the specifications might not be guaranteed. For guaranteed specifications and test conditions see the Electrical Characteristics.

Note2: The maximum power dissipation is a function of the maximum junction temperature, T_{Jmax}; total thermal resistance, θ_{JA}, and ambient temperature T_A. The maximum allowable power dissipation at any ambient temperature is T_{Jmax}-T_A / θ_{JA}. If this dissipation is exceeded, the die temperature will rise above 150°C and IC will go into thermal shutdown.

Note3: Low duty pulse techniques are used during test to maintain junction temperature as close to ambient as possible.

Note4: The type of output capacitor should be tantalum or aluminum.



Definitions

Output Voltage

The G1084 provides an adjustable output voltage from 1.25V to 5V. with two external resistors. It can be formulated as:

$$V_{OUT} = 1.25V \times \left(1 + \frac{R_2}{R_1}\right) + I_{ADJ} \times R_2$$

$$I_{ADJ} = 80\mu A \text{ (TYP.)}$$

Dropout Voltage

The input/output Voltage differential at which the regulator output no longer maintains regulation against further reductions in input voltage. Measured when the output drops 2% below its nominal value. Dropout voltage is affected by junction temperature, load current and minimum input supply requirements.

Line Regulation

The change in output voltage for a change in input voltage. The measurement is made under conditions of low dissipation or by using pulse techniques such that average chip temperature is not significantly affected.

Load Regulation

The change in output voltage for a change in load current at constant chip temperature. The measurement is made under conditions of low dissipation or by using pulse techniques such that average chip temperature is not significantly affected.

Maximum Power Dissipation

The maximum total device dissipation for which the regulator will operate within specifications.

Quiescent Bias Current

Current which is used to operate the regulator chip and is not delivered to the load.

EEPW.com.cn 電子產品世界



Typical Performance Characteristics

($V_{IN}-V_{OUT} = 3V$, $V_{OUT} = 1.25V$, $C_{IN} = 220\mu F$, $C_{OUT} = 220\mu F$, $T_A=25^\circ C$, unless otherwise noted.)

Line Transient Response

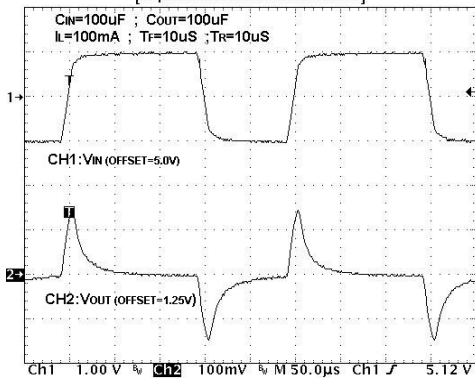

Load Transient Response

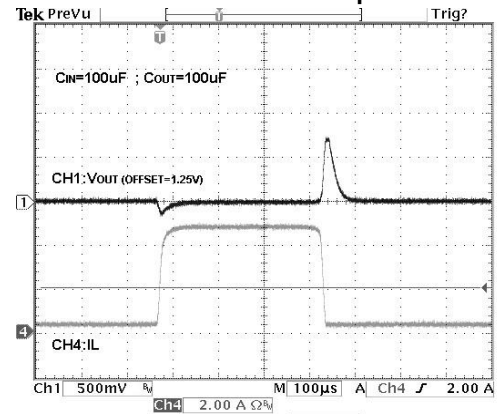

Short Circuit-Current

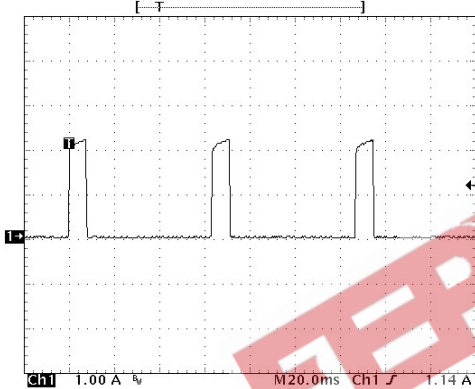

Output Noise

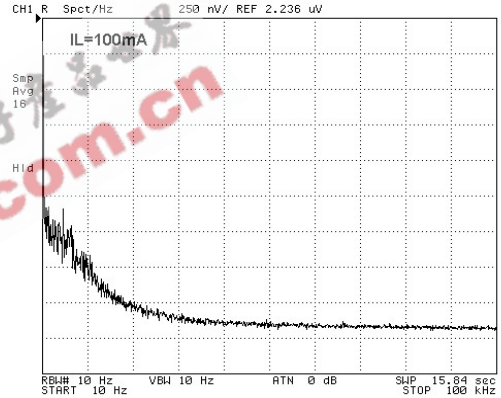

Ripple Rejection

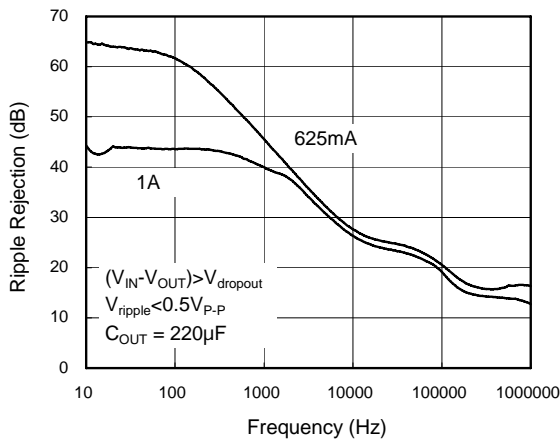

Line Regulation

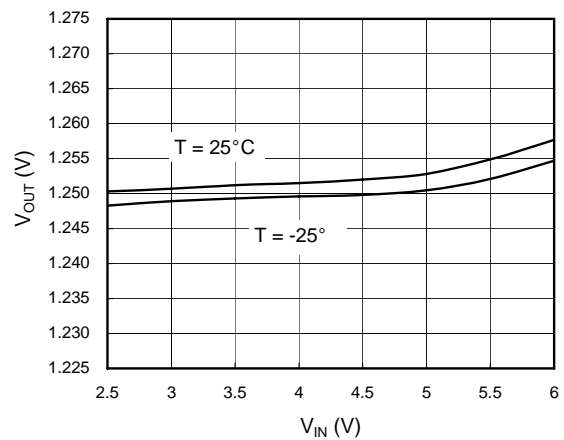



Typical Performance Characteristics (continued)

Dropout Voltage vs. I_{OUT}

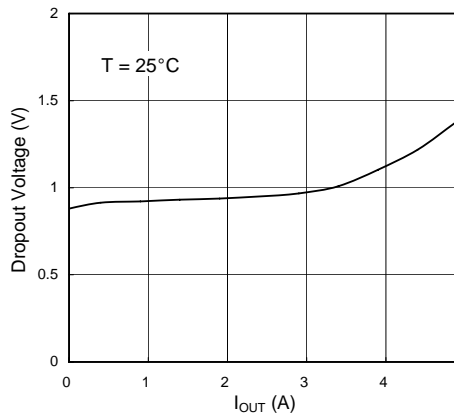

Load Regulation

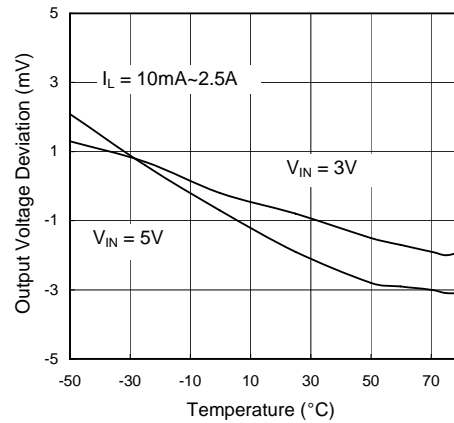

Output Voltage vs. Temperature

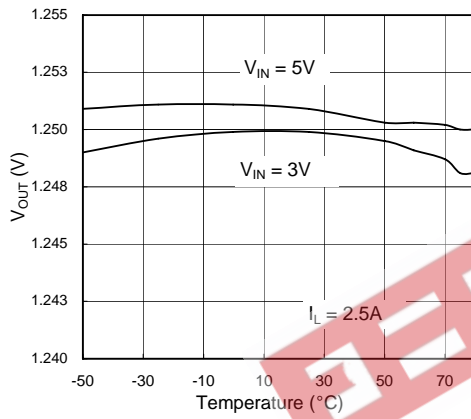

Adj Pin Current vs. Temperature

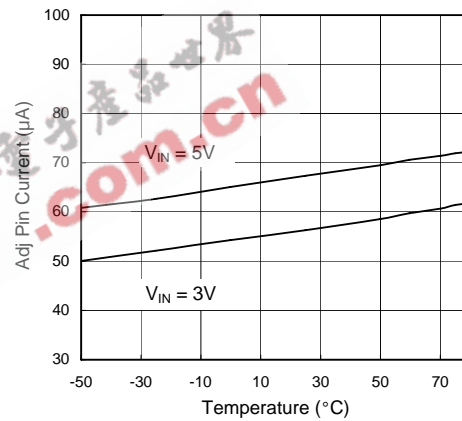

G1084T43(TO-252) Max. Power Dissipation vs. PCB Top Copper Area $T_{\text{AMB}} = 25^{\circ}\text{C}$; Still Air

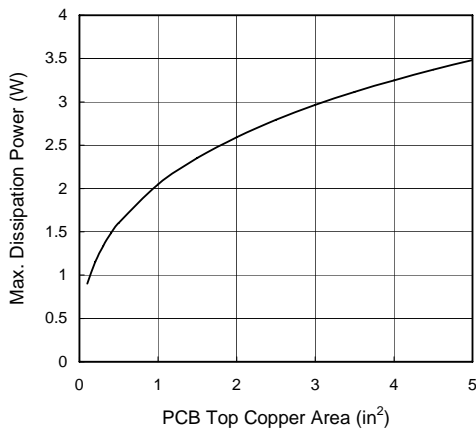

G1084T43(TO-252) Max. Power Dissipation vs. T_{AMB} (still air) (Different PCB Top Copper Area)

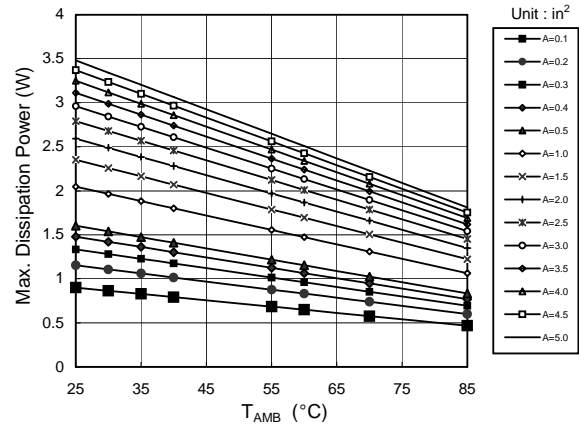

Typical Performance Characteristics (continued)

G1084T53(TO-263) Max. Power Dissipation vs. PCB Top Copper Area
 Area $T_{AMB} = 25^{\circ}C$; Still Air

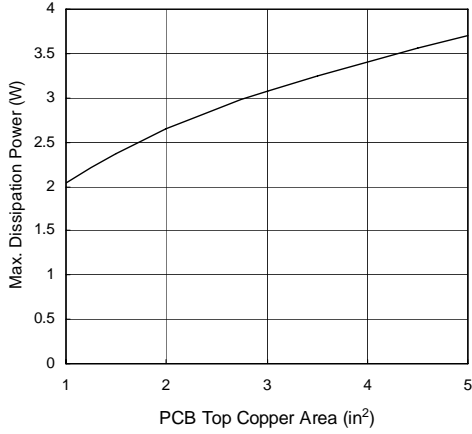

G1084T53(TO-263) Max. Power Dissipation vs. T_{AMB} (still air)
 (Different PCB Top Copper Area)

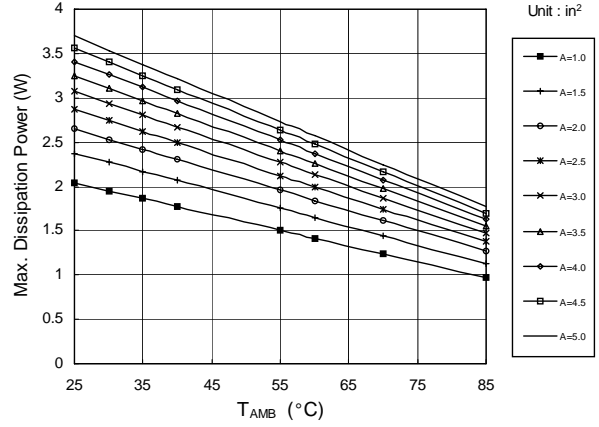

G1084T33 (TO-220) Max. Power Dissipation vs. Temperature

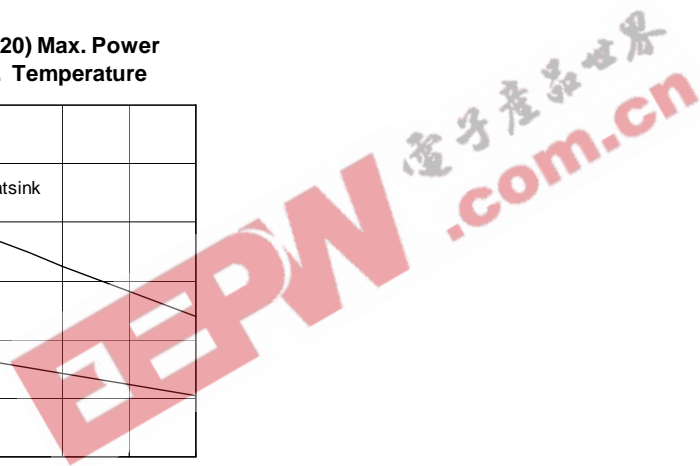
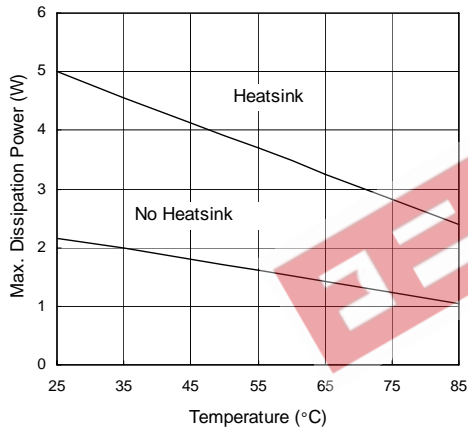

Recommended Minimum Footprint

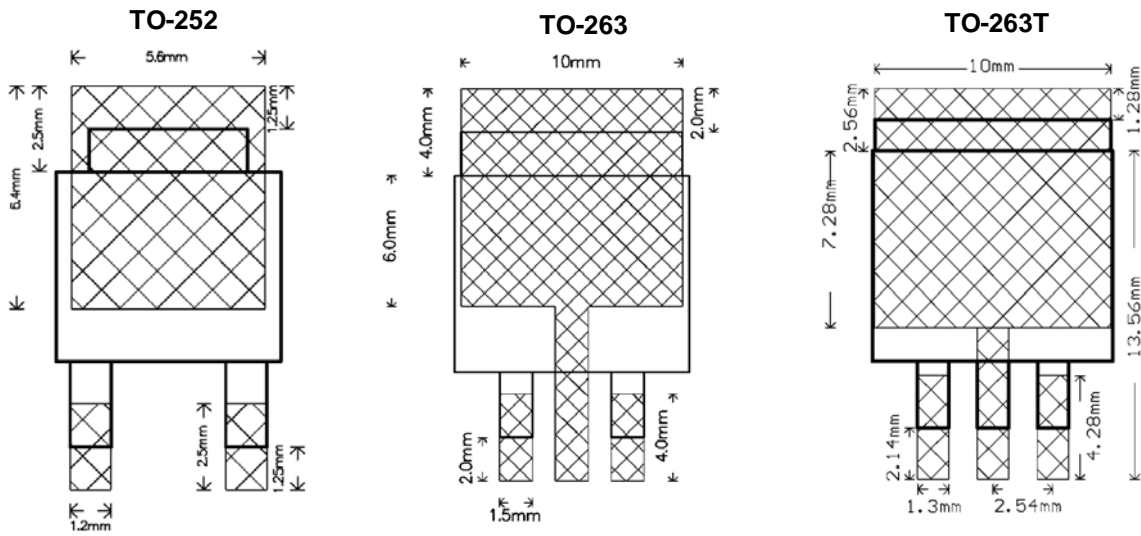

Heatsink Package Dimension

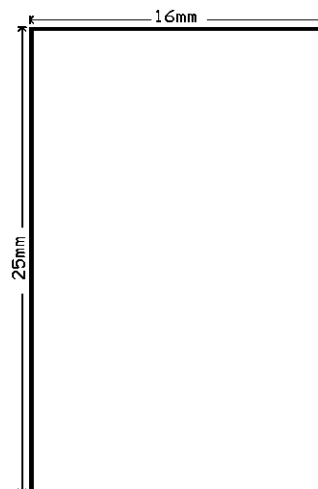
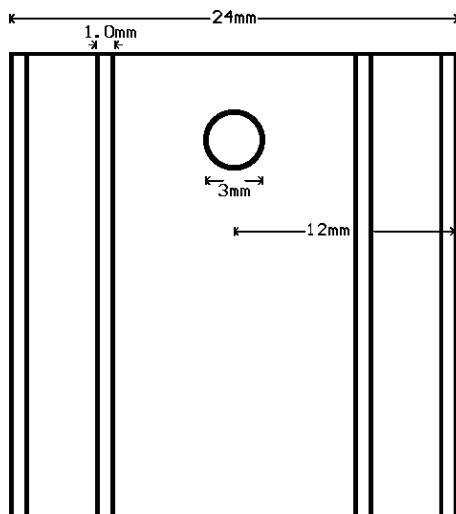
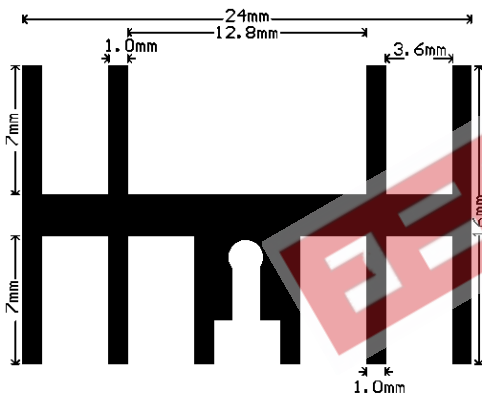

Package Information

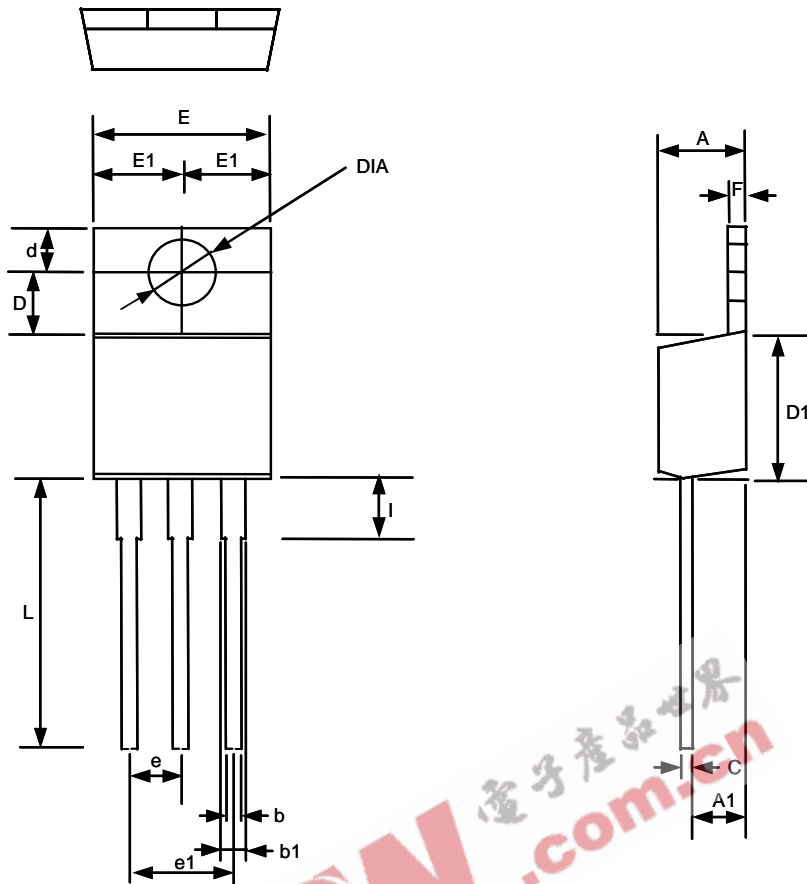

TO-220 (T3) Package

SYMBOL	MILLIMETER		INCH	
	MIN	MAX	MIN	MAX
A	4.318	4.826	0.170	0.190
A1	2.46	2.72	0.097	0.107
b	0.69	0.94	0.027	0.037
b1	1.143	1.397	0.045	0.055
C	0.304	0.460	0.012	0.018
D	3.429	3.683	0.135	0.145
D1	8.53	9.04	0.336	0.356
d	2.62	2.87	0.103	0.113
E	9.906	10.40	0.390	0.410
E1	4.953	5.22	0.195	0.206
DIA	3.708	3.962	0.146	0.156
e	2.29	2.79	0.090	0.110
e1	4.83	5.33	0.190	0.210
F	1.143	1.397	0.045	0.055
L	13.589	14.351	0.535	0.565
I	3.56	4.06	0.140	0.16

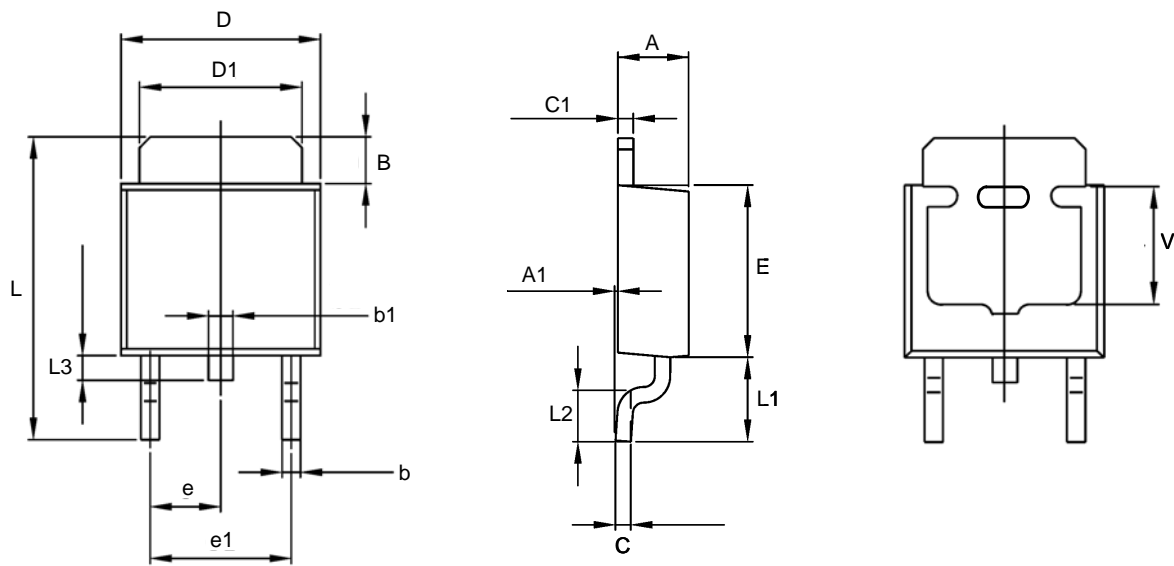

TO-252 (T4) Package

SYMBOL	MILLIMETERS		INCHES	
	MIN.	MAX.	MIN.	MAX.
A	2.190	2.400	0.086	0.094
A1	0.000	0.127	0.000	0.005
B	0.880	1.650	0.035	0.065
b	0.500	0.880	0.020	0.035
b1	0.700	0.900	0.028	0.035
C	0.430	0.580	0.017	0.023
C1	0.430	0.580	0.017	0.023
D	6.350	6.730	0.250	0.265
D1	5.200	5.460	0.205	0.215
E	5.400	6.220	0.213	0.245
e	2.300 TYP		0.091 TYP	
e1	4.500	4.700	0.177	0.185
L	8.830	10.77	0.348	0.424
L1	2.550	2.900	0.100	0.114
L2	1.400	1.780	0.055	0.070
L3	0.350	1.020	0.014	0.040
V	3.800	4.320	0.150	0.170

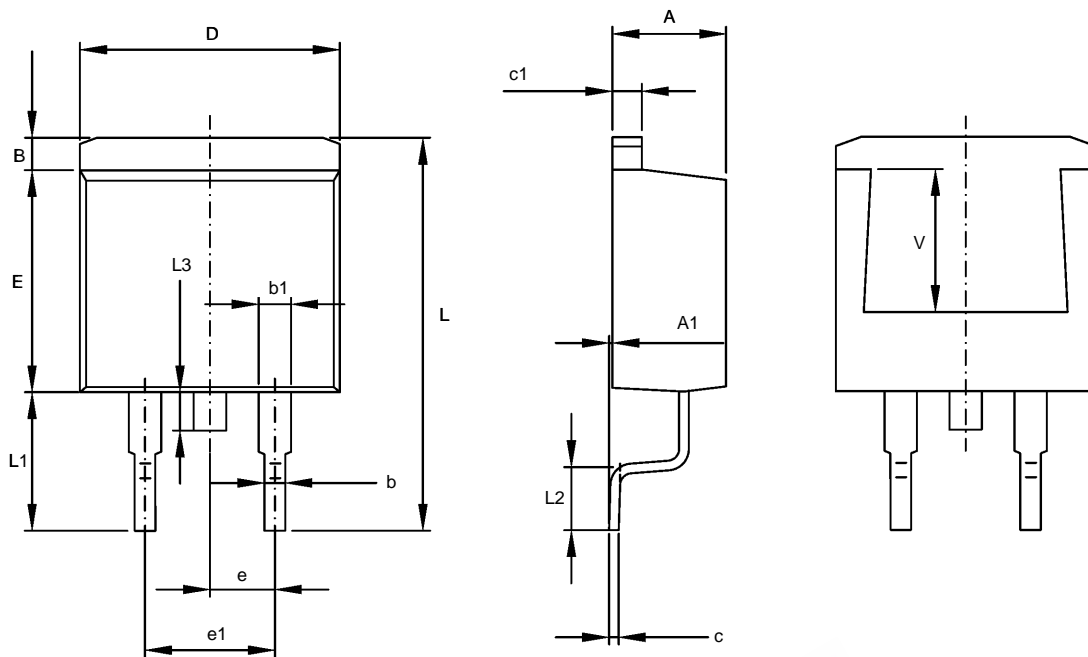

TO-263 (T5) Package

SYMBOL	MILLIMETER		INCH	
	MIN	MAX	MIN	MAX
A	4.470	4.670	0.176	0.184
A1	0.000	0.150	0.000	0.006
B	1.170	1.370	0.046	0.054
b	0.710	0.910	0.028	0.036
b1	1.170	1.370	0.046	0.054
c	0.310	0.530	0.012	0.021
c1	1.170	1.370	0.046	0.054
D	10.010	10.310	0.394	0.406
E	8.500	8.900	0.335	0.350
e	2.540 TYP		0.100 TYP	
e1	4.980	5.180	0.196	0.204
L	15.050	15.450	0.593	0.608
L1	5.080	5.480	0.200	0.216
L2	2.340	2.740	0.092	0.108
L3	1.300	1.700	0.051	0.067
V	5.600 REF		0.220 REF	

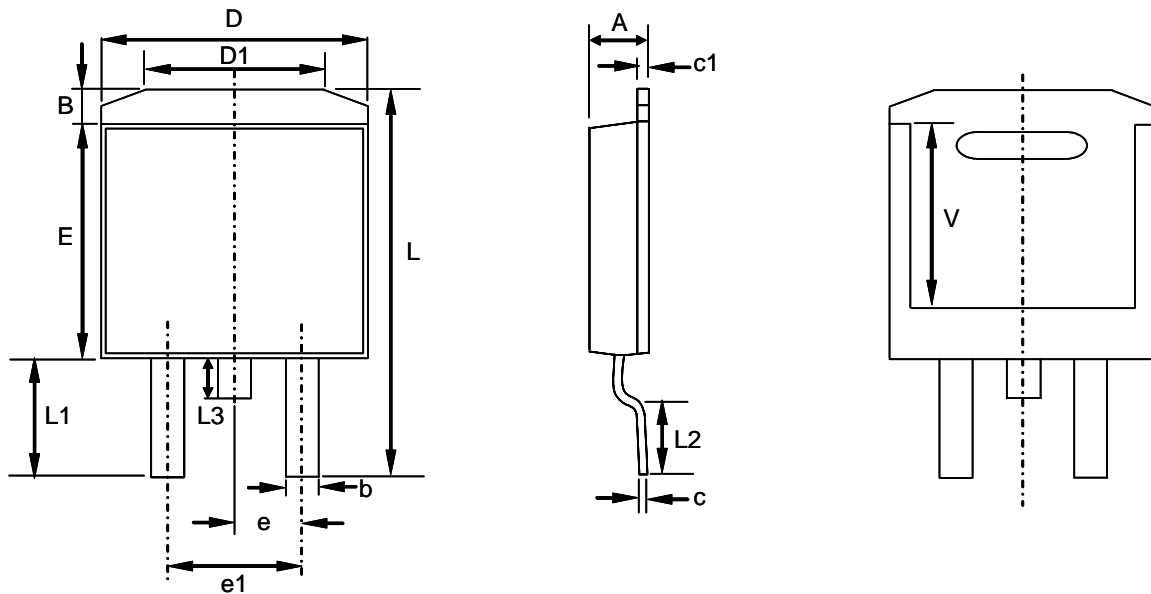

TO-263T (TU) Package

SYMBOL	DIMENSIONS IN MILLIMETER			DIMENSIONS IN INCH		
	MIN	NOM	MAX	MIN	NOM	MAX
A	1.750	2.000	2.250	0.069	0.079	0.089
B	0.880	1.280	1.680	0.345	0.050	0.066
b	1.255	1.295	1.335	0.049	0.051	0.053
c	0.381	0.406	0.431	0.015	0.016	0.017
c1	0.356	0.406	0.456	0.014	0.016	0.018
D	9.660	10.160	10.660	0.380	0.400	0.420
D1	6.900 REF			0.272 REF		
E	8.380	8.680	8.980	0.330	0.342	0.354
e	-----	2.540	-----	-----	0.100	-----
e1	-----	5.080	-----	-----	0.200	-----
L	13.74	14.240	14.740	0.541	0.561	0.580
L1	-----	4.280	-----	-----	0.169	-----
L2	2.290	2.540	2.790	0.090	0.100	0.110
L3	-----	-----	1.778	-----	-----	0.070
V	-----	7.280	-----	-----	0.287	-----

Taping Specification

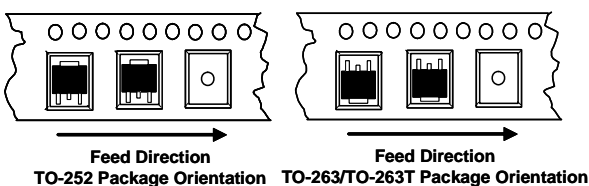

PACKAGE	Q'TY/REEL	Q'TY/TUBE
TO-220	-----	50 ea
TO-252	2,500 ea	-----
TO-263	800 ea	-----
TO-263T	1,500 ea	-----

GMT Inc. does not assume any responsibility for use of any circuitry described, no circuit patent licenses are implied and GMT Inc. reserves the right at any time without notice to change said circuitry and specifications.