

**PSM Step-up DC/DC Converter****Features**

- 1~4 Cell Alkaline Battery Operating Range
- Output Voltage Range: 2.5V~5.0V in 0.1V Increments
- Minimum External Component (L, D, C)
- 100kHz Max. Oscillation Frequency
- 75% Duty Ratio
- Up to 80% Efficiency
- $\pm 2\%$  High Output Voltage Accuracy
- $< 100\text{ppm}/^\circ\text{C}$  Temperature Coefficient
- SOT-89 and SOT-23-5 Small Packages

**Applications**

- Power Source for Portable Equipments
- Handheld Computers, Palmtops
- Digital Still Cameras, Camcorders
- Cellular Phones, Pagers
- Portable Multimedia Players

**General Description**

The G5130/G5131 boost converter is designed for use of main power source on portable equipments.

It consist of an oscillator, PSM control logic circuit, an embedded power MOS (LX switch), accurate voltage reference, error amplifier, feedback resistors, and LX protection circuit.

Only 3 external components (includes 1 inductor, 1 diode and 1 capacitor) are needed to construct the power application.

For larger output power application, G5131 can be used to drive an external NPN device for more input current.

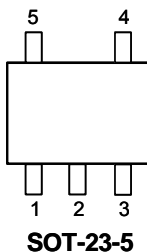
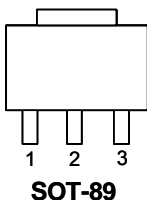
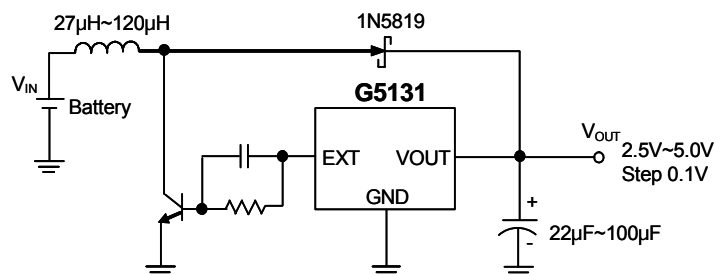
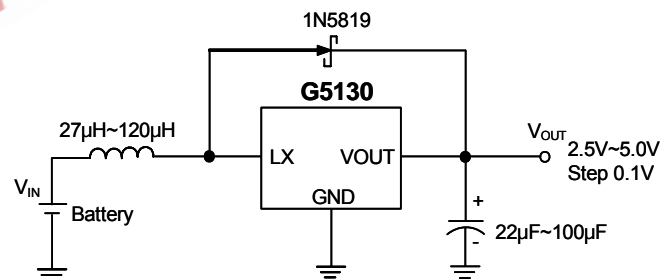
**Pin Configuration****Typical Application Circuit**



Ordering Information

| ORDER NUMBER | ORDER NUMBER (Pb free) | MARKING | OUTPUT VOLTAGE (V) | TEMP. RANGE   | PACKAGE  |
|--------------|------------------------|---------|--------------------|---------------|----------|
| G5130-27T11U | G5130-27T11Uf          | EA27x   | 2.7                | -40°C ~ +85°C | SOT-23-5 |
| G5130-30T11U | G5130-30T11Uf          | EA30x   | 3.0                | -40°C ~ +85°C | SOT-23-5 |
| G5130-33T11U | G5130-33T11Uf          | EA33x   | 3.3                | -40°C ~ +85°C | SOT-23-5 |
| G5130-42T11U | G5130-42T11Uf          | EA42x   | 4.2                | -40°C ~ +85°C | SOT-23-5 |
| G5130-50T11U | G5130-50T11Uf          | EA50x   | 5.0                | -40°C ~ +85°C | SOT-23-5 |
| G5130-27T21U | G5130-27T21Uf          | 5130Cx  | 2.7                | -40°C ~ +85°C | SOT-89   |
| G5130-30T21U | G5130-30T21Uf          | 5130Fx  | 3.0                | -40°C ~ +85°C | SOT-89   |
| G5130-33T21U | G5130-33T21Uf          | 5130Ix  | 3.3                | -40°C ~ +85°C | SOT-89   |
| G5130-42T21U | G5130-42T21Uf          | 5130Rx  | 4.2                | -40°C ~ +85°C | SOT-89   |
| G5130-50T21U | G5130-50T21Uf          | 5130Zx  | 5.0                | -40°C ~ +85°C | SOT-89   |
| G5131-27T11U | G5131-27T11Uf          | EB27x   | 2.7                | -40°C ~ +85°C | SOT-23-5 |
| G5131-30T11U | G5131-30T11Uf          | EB30x   | 3.0                | -40°C ~ +85°C | SOT-23-5 |
| G5131-33T11U | G5131-33T11Uf          | EB33x   | 3.3                | -40°C ~ +85°C | SOT-23-5 |
| G5131-42T11U | G5131-42T11Uf          | EB42x   | 4.2                | -40°C ~ +85°C | SOT-23-5 |
| G5131-50T11U | G5131-50T11Uf          | EB50x   | 5.0                | -40°C ~ +85°C | SOT-23-5 |
| G5131-27T21U | G5131-27T21Uf          | 5131Cx  | 2.7                | -40°C ~ +85°C | SOT-89   |
| G5131-30T21U | G5131-30T21Uf          | 5131Fx  | 3.0                | -40°C ~ +85°C | SOT-89   |
| G5131-33T21U | G5131-33T21Uf          | 5131Ix  | 3.3                | -40°C ~ +85°C | SOT-89   |
| G5131-42T21U | G5131-42T21Uf          | 5131Rx  | 4.2                | -40°C ~ +85°C | SOT-89   |
| G5131-50T21U | G5131-50T21Uf          | 5131Zx  | 5.0                | -40°C ~ +85°C | SOT-89   |

For other output voltage, please contact us at sales@gmt.com.tw

Order Number Identification

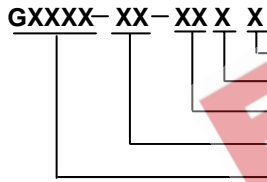

- ➔ Packing Type
  - ➔ Pin Option
  - ➔ Package Type
  - ➔ Voltage Option
  - ➔ Part Number
- G5130: Internal MOS (LX)  
G5131: External MOS (EXT)

PACKAGE TYPE

T1 : SOT-23-5  
T2 : SOT-89

PIN OPTION

|       | SOT89 |      |     | SOT23-5 |      |    |     |     |
|-------|-------|------|-----|---------|------|----|-----|-----|
|       | 1     | 2    | 3   | 1       | 2    | 3  | 4   | 5   |
| G5130 | 1:GND | VOUT | LX  | 1: CE   | VOUT | NC | GND | LX  |
| G5131 | 1:GND | VOUT | EXT | 1: CE   | VOUT | NC | GND | EXT |

PACKING

U: Tape & Reel Direction



## Selector Guide

| ORDER NUMBER | ORDER NUMBER (Pb free) | OUTPUT VOLTAGE (V) | MARKING |
|--------------|------------------------|--------------------|---------|
| G5130-25T11U | G5130-25T11Uf          | 2.5                | EA25x   |
| G5130-26T11U | G5130-26T11Uf          | 2.6                | EA26x   |
| G5130-27T11U | G5130-27T11Uf          | 2.7                | EA27x   |
| G5130-28T11U | G5130-28T11Uf          | 2.8                | EA28x   |
| G5130-29T11U | G5130-29T11Uf          | 2.9                | EA29x   |
| G5130-30T11U | G5130-30T11Uf          | 3.0                | EA30x   |
| G5130-31T11U | G5130-31T11Uf          | 3.1                | EA31x   |
| G5130-32T11U | G5130-32T11Uf          | 3.2                | EA32x   |
| G5130-33T11U | G5130-33T11Uf          | 3.3                | EA33x   |
| G5130-34T11U | G5130-34T11Uf          | 3.4                | EA34x   |
| G5130-35T11U | G5130-35T11Uf          | 3.5                | EA35x   |
| G5130-36T11U | G5130-36T11Uf          | 3.6                | EA36x   |
| G5130-37T11U | G5130-37T11Uf          | 3.7                | EA37x   |
| G5130-38T11U | G5130-38T11Uf          | 3.8                | EA38x   |
| G5130-39T11U | G5130-39T11Uf          | 3.9                | EA39x   |
| G5130-40T11U | G5130-40T11Uf          | 4.0                | EA40x   |
| G5130-41T11U | G5130-41T11Uf          | 4.1                | EA41x   |
| G5130-42T11U | G5130-42T11Uf          | 4.2                | EA42x   |
| G5130-43T11U | G5130-43T11Uf          | 4.3                | EA43x   |
| G5130-44T11U | G5130-44T11Uf          | 4.4                | EA44x   |
| G5130-45T11U | G5130-45T11Uf          | 4.5                | EA45x   |
| G5130-46T11U | G5130-46T11Uf          | 4.6                | EA46x   |
| G5130-47T11U | G5130-47T11Uf          | 4.7                | EA47x   |
| G5130-48T11U | G5130-48T11Uf          | 4.8                | EA48x   |
| G5130-49T11U | G5130-49T11Uf          | 4.9                | EA49x   |
| G5130-50T11U | G5130-50T11Uf          | 5.0                | EA50x   |

Note: T1: SOT-23-5

## Selector Guide

| ORDER NUMBER | ORDER NUMBER (Pb free) | OUTPUT VOLTAGE (V) | MARKING |
|--------------|------------------------|--------------------|---------|
| G5130-25T21U | G5130-25T21Uf          | 2.5                | 5130Ax  |
| G5130-26T21U | G5130-26T21Uf          | 2.6                | 5130Bx  |
| G5130-27T21U | G5130-27T21Uf          | 2.7                | 5130Cx  |
| G5130-28T21U | G5130-28T21Uf          | 2.8                | 5130Dx  |
| G5130-29T21U | G5130-29T21Uf          | 2.9                | 5130Ex  |
| G5130-30T21U | G5130-30T21Uf          | 3.0                | 5130Fx  |
| G5130-31T21U | G5130-31T21Uf          | 3.1                | 5130Gx  |
| G5130-32T21U | G5130-32T21Uf          | 3.2                | 5130Hx  |
| G5130-33T21U | G5130-33T21Uf          | 3.3                | 5130Ix  |
| G5130-34T21U | G5130-34T21Uf          | 3.4                | 5130Jx  |
| G5130-35T21U | G5130-35T21Uf          | 3.5                | 5130Kx  |
| G5130-36T21U | G5130-36T21Uf          | 3.6                | 5130Lx  |
| G5130-37T21U | G5130-37T21Uf          | 3.7                | 5130Mx  |
| G5130-38T21U | G5130-38T21Uf          | 3.8                | 5130Nx  |
| G5130-39T21U | G5130-39T21Uf          | 3.9                | 5130Ox  |
| G5130-40T21U | G5130-40T21Uf          | 4.0                | 5130Px  |
| G5130-41T21U | G5130-41T21Uf          | 4.1                | 5130Qx  |
| G5130-42T21U | G5130-42T21Uf          | 4.2                | 5130Rx  |
| G5130-43T21U | G5130-43T21Uf          | 4.3                | 5130Sx  |
| G5130-44T21U | G5130-44T21Uf          | 4.4                | 5130Tx  |
| G5130-45T21U | G5130-45T21Uf          | 4.5                | 5130Ux  |
| G5130-46T21U | G5130-46T21Uf          | 4.6                | 5130Vx  |
| G5130-47T21U | G5130-47T21Uf          | 4.7                | 5130Wx  |
| G5130-48T21U | G5130-48T21Uf          | 4.8                | 5130Xx  |
| G5130-49T21U | G5130-49T21Uf          | 4.9                | 5130Yx  |
| G5130-50T21U | G5130-50T21Uf          | 5.0                | 5130Zx  |

Note: T2: SOT-89



## Selector Guide

| ORDER NUMBER | ORDER NUMBER (Pb free) | OUTPUT VOLTAGE (V) | MARKING |
|--------------|------------------------|--------------------|---------|
| G5131-25T11U | G5131-25T11Uf          | 2.5                | EB25x   |
| G5131-26T11U | G5131-26T11Uf          | 2.6                | EB26x   |
| G5131-27T11U | G5131-27T11Uf          | 2.7                | EB27x   |
| G5131-28T11U | G5131-28T11Uf          | 2.8                | EB28x   |
| G5131-29T11U | G5131-29T11Uf          | 2.9                | EB29x   |
| G5131-30T11U | G5131-30T11Uf          | 3.0                | EB30x   |
| G5131-31T11U | G5131-31T11Uf          | 3.1                | EB31x   |
| G5131-32T11U | G5131-32T11Uf          | 3.2                | EB32x   |
| G5131-33T11U | G5131-33T11Uf          | 3.3                | EB33x   |
| G5131-34T11U | G5131-34T11Uf          | 3.4                | EB34x   |
| G5131-35T11U | G5131-35T11Uf          | 3.5                | EB35x   |
| G5131-36T11U | G5131-36T11Uf          | 3.6                | EB36x   |
| G5131-37T11U | G5131-37T11Uf          | 3.7                | EB37x   |
| G5131-38T11U | G5131-38T11Uf          | 3.8                | EB38x   |
| G5131-39T11U | G5131-39T11Uf          | 3.9                | EB39x   |
| G5131-40T11U | G5131-40T11Uf          | 4.0                | EB40x   |
| G5131-41T11U | G5131-41T11Uf          | 4.1                | EB41x   |
| G5131-42T11U | G5131-42T11Uf          | 4.2                | EB42x   |
| G5131-43T11U | G5131-43T11Uf          | 4.3                | EB43x   |
| G5131-44T11U | G5131-44T11Uf          | 4.4                | EB44x   |
| G5131-45T11U | G5131-45T11Uf          | 4.5                | EB45x   |
| G5131-46T11U | G5131-46T11Uf          | 4.6                | EB46x   |
| G5131-47T11U | G5131-47T11Uf          | 4.7                | EB47x   |
| G5131-48T11U | G5131-48T11Uf          | 4.8                | EB48x   |
| G5131-49T11U | G5131-49T11Uf          | 4.9                | EB49x   |
| G5131-50T11U | G5131-50T11Uf          | 5.0                | EB50x   |

Note: T1: SOT-23-5

## Selector Guide

| ORDER NUMBER | ORDER NUMBER (Pb free) | OUTPUT VOLTAGE (V) | MARKING |
|--------------|------------------------|--------------------|---------|
| G5131-25T21U | G5131-25T21Uf          | 2.5                | 5131Ax  |
| G5131-26T21U | G5131-26T21Uf          | 2.6                | 5131Bx  |
| G5131-27T21U | G5131-27T21Uf          | 2.7                | 5131Cx  |
| G5131-28T21U | G5131-28T21Uf          | 2.8                | 5131Dx  |
| G5131-29T21U | G5131-29T21Uf          | 2.9                | 5131Ex  |
| G5131-30T21U | G5131-30T21Uf          | 3.0                | 5131Fx  |
| G5131-31T21U | G5131-31T21Uf          | 3.1                | 5131Gx  |
| G5131-32T21U | G5131-32T21Uf          | 3.2                | 5131Hx  |
| G5131-33T21U | G5131-33T21Uf          | 3.3                | 5131Ix  |
| G5131-34T21U | G5131-34T21Uf          | 3.4                | 5131Jx  |
| G5131-35T21U | G5131-35T21Uf          | 3.5                | 5131Kx  |
| G5131-36T21U | G5131-36T21Uf          | 3.6                | 5131Lx  |
| G5131-37T21U | G5131-37T21Uf          | 3.7                | 5131Mx  |
| G5131-38T21U | G5131-38T21Uf          | 3.8                | 5131Nx  |
| G5131-39T21U | G5131-39T21Uf          | 3.9                | 5131Ox  |
| G5131-40T21U | G5131-40T21Uf          | 4.0                | 5131Px  |
| G5131-41T21U | G5131-41T21Uf          | 4.1                | 5131Qx  |
| G5131-42T21U | G5131-42T21Uf          | 4.2                | 5131Rx  |
| G5131-43T21U | G5131-43T21Uf          | 4.3                | 5131Sx  |
| G5131-44T21U | G5131-44T21Uf          | 4.4                | 5131Tx  |
| G5131-45T21U | G5131-45T21Uf          | 4.5                | 5131Ux  |
| G5131-46T21U | G5131-46T21Uf          | 4.6                | 5131Vx  |
| G5131-47T21U | G5131-47T21Uf          | 4.7                | 5131Wx  |
| G5131-48T21U | G5131-48T21Uf          | 4.8                | 5131Xx  |
| G5131-49T21U | G5131-49T21Uf          | 4.9                | 5131Yx  |
| G5131-50T21U | G5131-50T21Uf          | 5.0                | 5131Zx  |

Note: T2: SOT-89

## Absolute Maximum Ratings

|  |                |  |                 |
|--|----------------|--|-----------------|
| LX to GND . . . . .                            | -0.3V to +7V   | Junction Temperature . . . . .                   | +125°C          |
| CE to GND . . . . .                            | -0.3V to +7V   | Storage Temperature . . . . .                    | -65°C to +150°C |
| VOUT to GND . . . . .                          | -0.3V to +7V   | Reflow Temperature (soldering, 10 sec) . . . . . | +260°C          |
| Operating Temperature Range (Note 1) . . . . . | -40°C to +85°C | ESD Rating (Human Body Model) . . . . .          | .2kV            |

Stress beyond those listed under "Absolute Maximum Rating" may cause permanent damage to the device.

## Electrical Characteristics

( $V_{OUT} = 3.3V$ ,  $V_{IN} = 1.8V$ ,  $T_A = 25^\circ C$ )

| PARAMETER                     | CONDITION                  | MIN | TYP | MAX | UNIT     |
|-------------------------------|----------------------------|-----|-----|-----|----------|
| Output Voltage Accuracy       |                            | -2  | --- | +2  | %        |
| Input Voltage Range           |                            | --- | --- | 6.5 | V        |
| Start-up Voltage              |                            | --- | 0.9 | --- | V        |
| Hold-on Voltage               |                            | --- | 0.5 | --- | V        |
| Input Current                 | No Switching ( $I_{DD2}$ ) | --- | 10  | 15  | $\mu A$  |
|                               | Switching ( $I_{DD1}$ )    | --- | 20  | --- | $\mu A$  |
|                               | No Load ( $I_{IN}$ )       | --- | 30  | --- | $\mu A$  |
| LX Switch On Resistance       | $V_{LX} = 0.4V$            | --- | 2   | 6   | $\Omega$ |
| LX Leakage Current            | $V_{LX} = 6.0V$            | --- | --- | 0.1 | $\mu A$  |
| Maximum Oscillation Frequency |                            | 70  | 100 | 130 | kHz      |
| Duty Cycle                    |                            | 65  | 75  | 85  | %        |
| $V_{LX}$ Voltage Limit        |                            | --- | 1   | --- | V        |
| Efficiency                    |                            | --- | 80  | --- | %        |

Note 1: The G5130 are guaranteed to meet performance specifications from 0°C to 85°C. Specifications over the -40°C to 85°C operating temperature range are assured by design, characterization and correlation with statistical process controls.

## Block Diagram

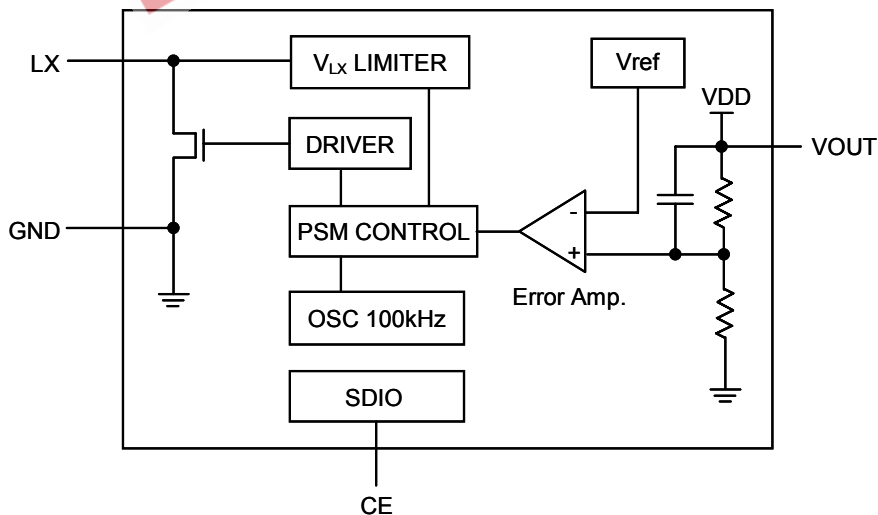



### Typical Performance Characteristics

( $V_{IN} = +3.0V$ ,  $L = 100\mu H$ ,  $C = 47\mu F$  (Tantalum),  $T_A = 25^\circ C$ , unless otherwise noted.)

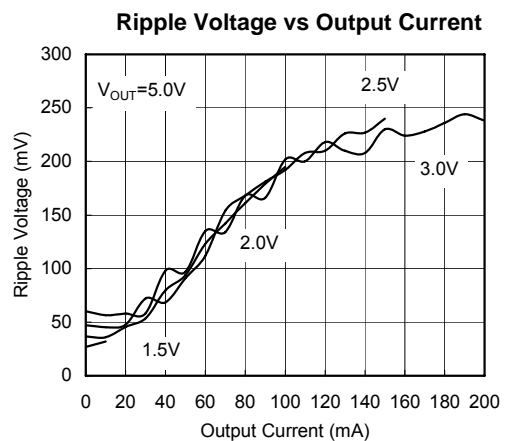
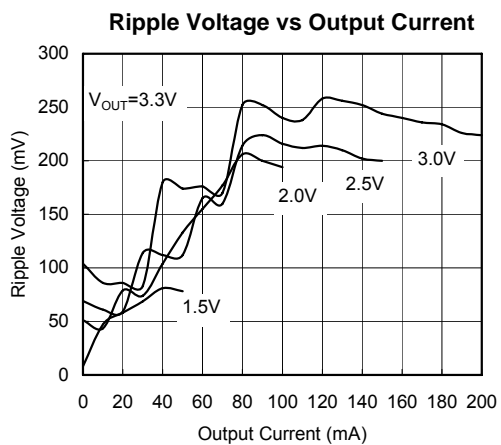
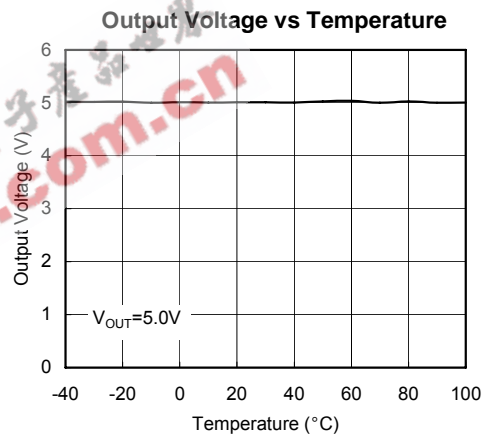
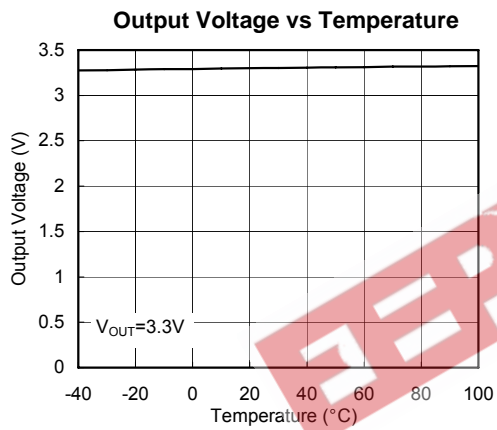
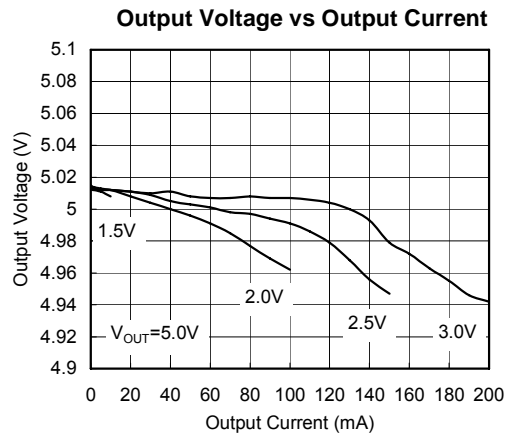
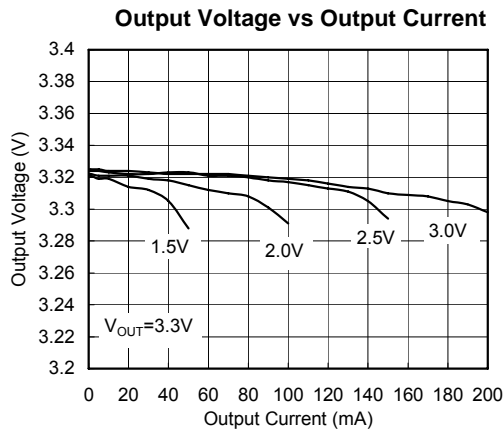



Typical Performance Characteristics (continued)

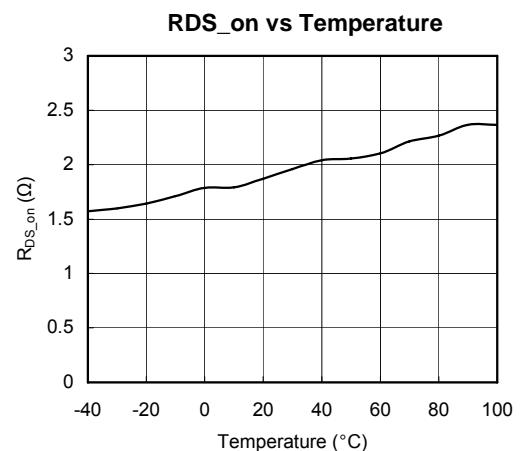
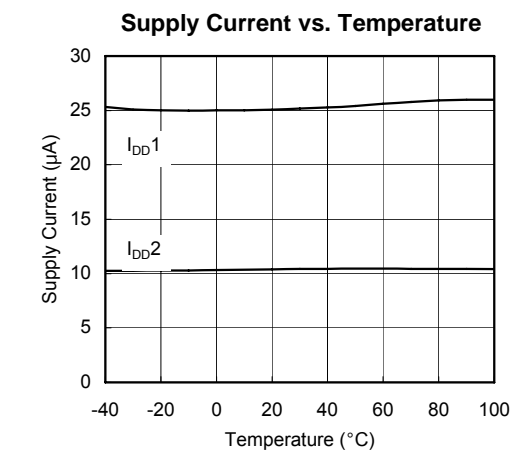
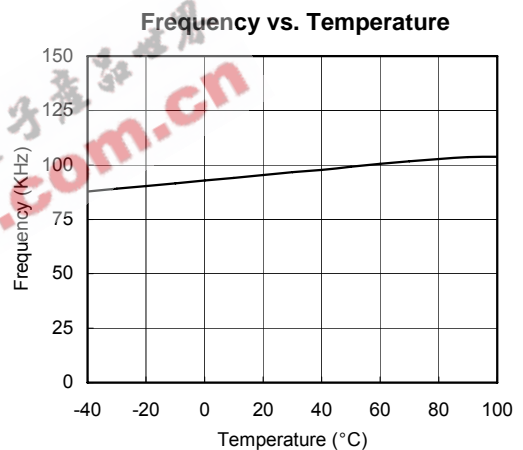
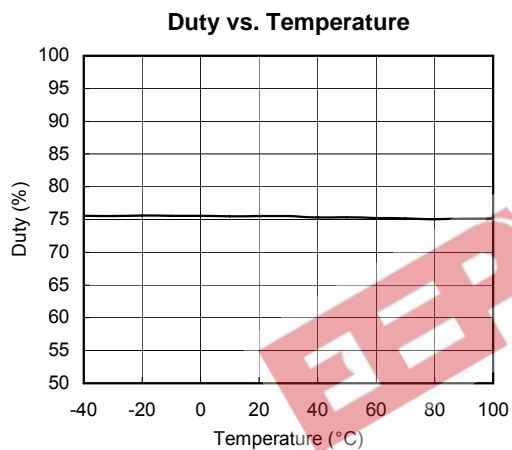
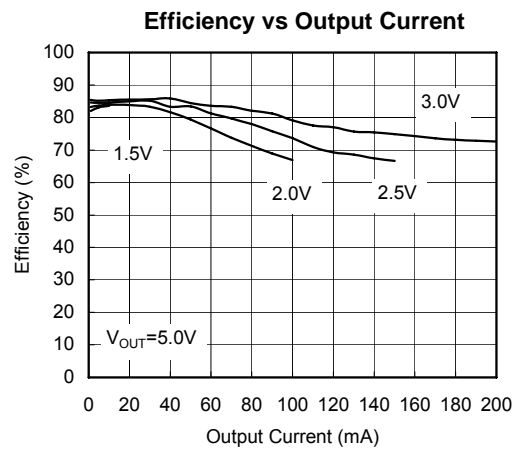
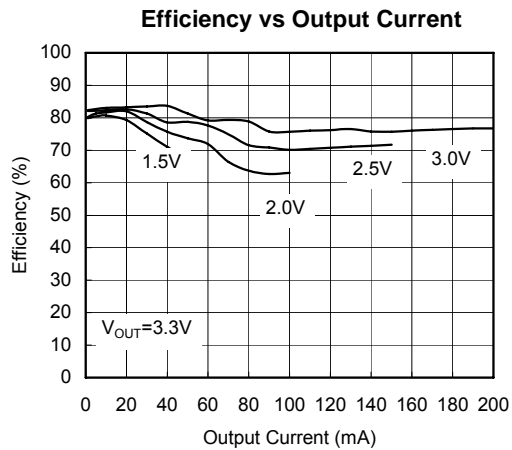



Typical Performance Characteristics (continued)

Line Transient

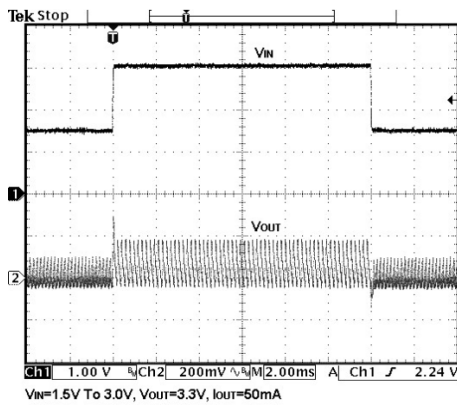

Line Transient

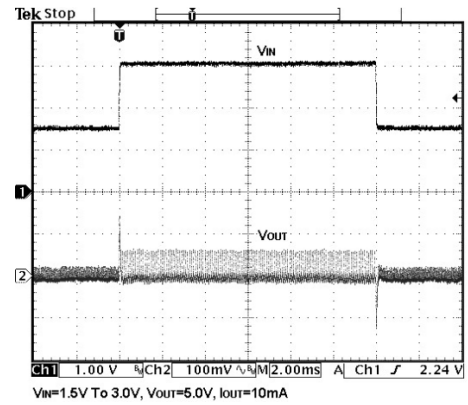

Load Transient

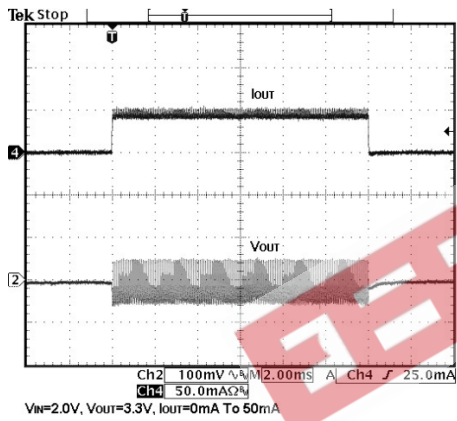

Load Transient

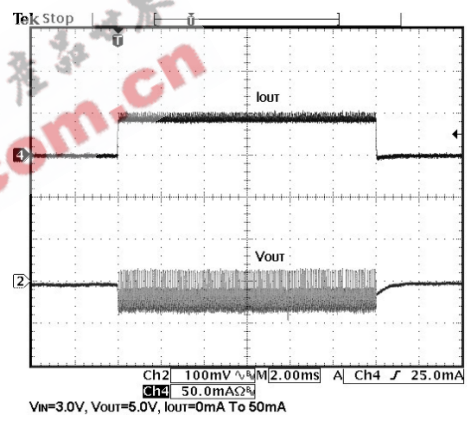

Power On Response

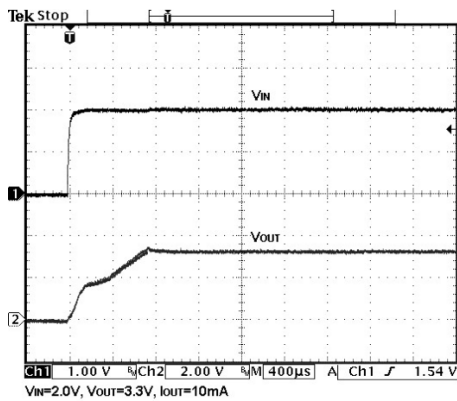

Power On Response

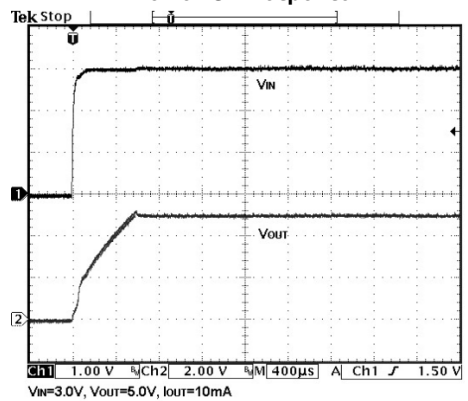





Recommended Minimum Footprint

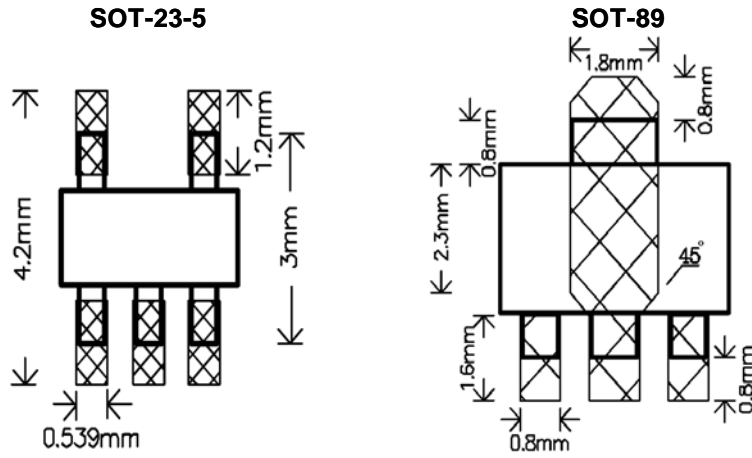

EEPW 电子产品世界 .com.cn

Package Information

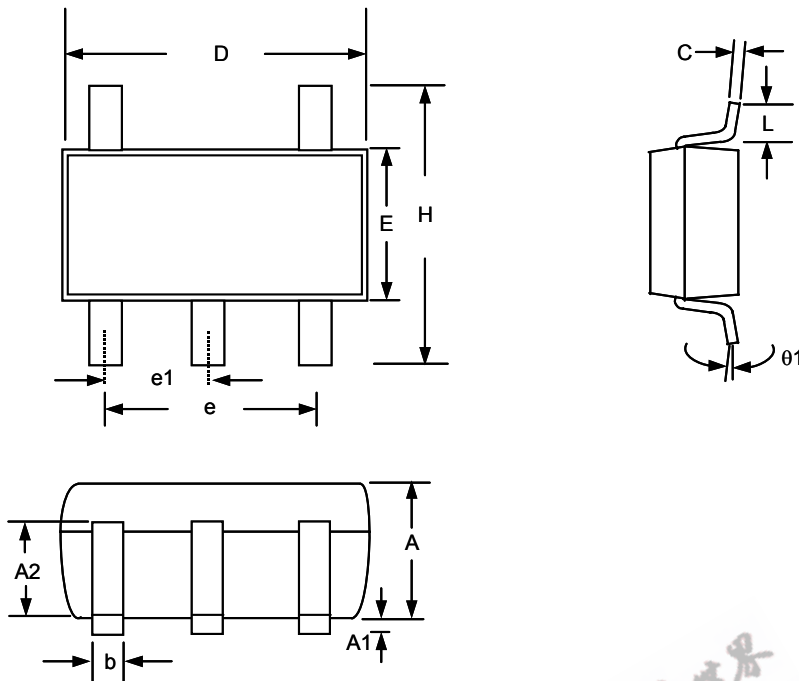

SOT-23-5 (T1) Package

Note:

1. Package body sizes exclude mold flash protrusions or gate burrs
2. Tolerance  $\pm 0.1000$  mm (4mil) unless otherwise specified
3. Coplanarity: 0.1000mm
4. Dimension L is measured in gage plane

| SYMBOL     | DIMENSION IN MM |           |       | DIMENSION IN INCH |            |       |
|------------|-----------------|-----------|-------|-------------------|------------|-------|
|            | MIN.            | NOM.      | MAX.  | MIN.              | NOM.       | MAX.  |
| A          | 1.00            | 1.10      | 1.30  | 0.039             | 0.043      | 0.051 |
| A1         | 0.00            | -----     | 0.10  | 0.000             | -----      | 0.004 |
| A2         | 0.70            | 0.80      | 0.90  | 0.028             | 0.031      | 0.035 |
| b          | 0.35            | 0.40      | 0.50  | 0.014             | 0.016      | 0.020 |
| C          | 0.10            | 0.15      | 0.25  | 0.004             | 0.006      | 0.010 |
| D          | 2.70            | 2.90      | 3.10  | 0.106             | 0.114      | 0.122 |
| E          | 1.40            | 1.60      | 1.80  | 0.055             | 0.063      | 0.071 |
| e          | -----           | 1.90(TYP) | ----- | -----             | 0.075(TYP) | ----- |
| e1         | -----           | 0.95      | ----- | -----             | 0.037      | ----- |
| H          | 2.60            | 2.80      | 3.00  | 0.102             | 0.110      | 0.118 |
| L          | 0.37            | -----     | ----- | 0.015             | -----      | ----- |
| $\theta 1$ | 1°              | 5°        | 9°    | 1°                | 5°         | 9°    |

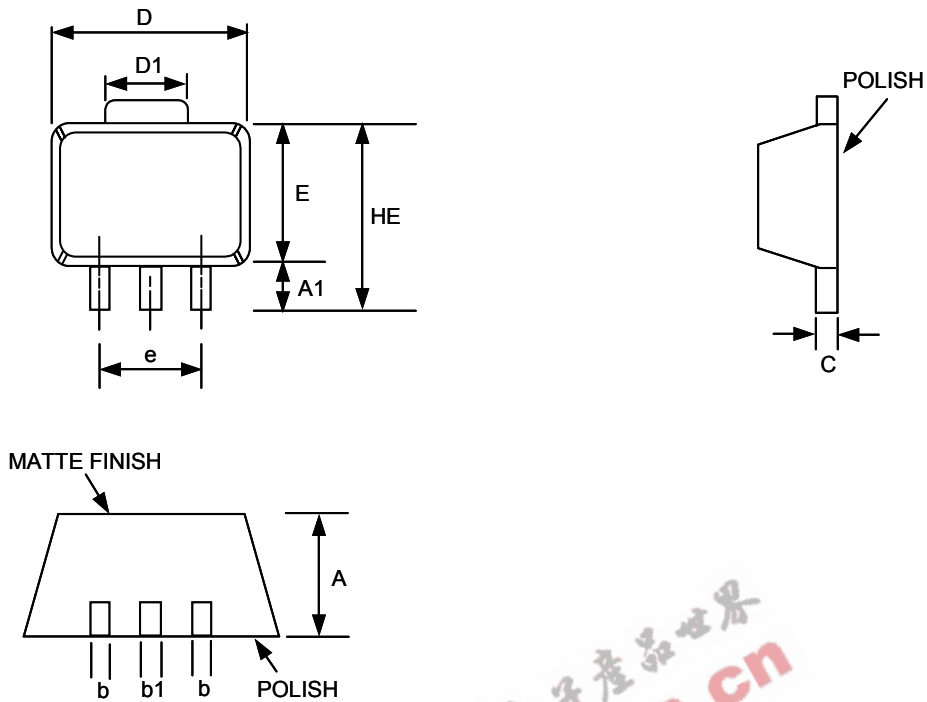

SOT-89 (T2) Package

| SYMBOL | DIMENSIONS IN MILLIMETER |      |      | DIMENSIONS IN INCH |       |       |
|--------|--------------------------|------|------|--------------------|-------|-------|
|        | MIN                      | NOM  | MAX  | MIN                | NOM   | MAX   |
| A      | 1.40                     | 1.50 | 1.60 | 0.055              | 0.059 | 0.063 |
| A1     | 0.80                     | 1.04 | ---- | 0.031              | 0.041 | ----  |
| b      | 0.36                     | 0.42 | 0.48 | 0.014              | 0.016 | 0.018 |
| b1     | 0.41                     | 0.47 | 0.53 | 0.016              | 0.018 | 0.020 |
| C      | 0.38                     | 0.40 | 0.43 | 0.014              | 0.015 | 0.017 |
| D      | 4.40                     | 4.50 | 4.60 | 0.173              | 0.177 | 0.181 |
| D1     | 1.40                     | 1.60 | 1.75 | 0.055              | 0.062 | 0.069 |
| HE     | ----                     | ---- | 4.25 | ----               | ----  | 0.167 |
| E      | 2.40                     | 2.50 | 2.60 | 0.094              | 0.098 | 0.102 |
| e      | 2.90                     | 3.00 | 3.10 | 0.114              | 0.118 | 0.122 |

**Taping Specification**

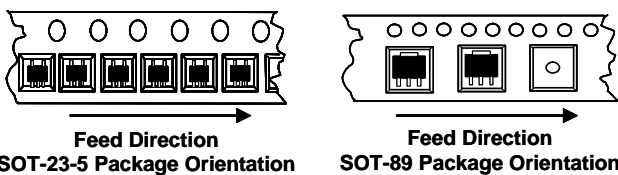

| PACKAGE  | Q'TY/REEL |
|----------|-----------|
| SOT-23-5 | 3,000 ea  |
| SOT-89   | 1,000 ea  |

GMT Inc. does not assume any responsibility for use of any circuitry described, no circuit patent licenses are implied and GMT Inc. reserves the right at any time without notice to change said circuitry and specifications.