

GS1A THRU GS1M

SURFACE MOUNT RECTIFIER

VOLTAGE - 50 to 1000 Volts CURRENT - 1.0 Ampere

FEATURES

- For surface mounted applications
- Low profile package
- Built-in strain relief
- Easy pick and place
- Plastic package has Underwriters Laboratory

Flammability Classification 94V-O

- Glass passivated chip junction
- High temperature soldering:
260 /10 seconds at terminals

SMA/DO-214AC

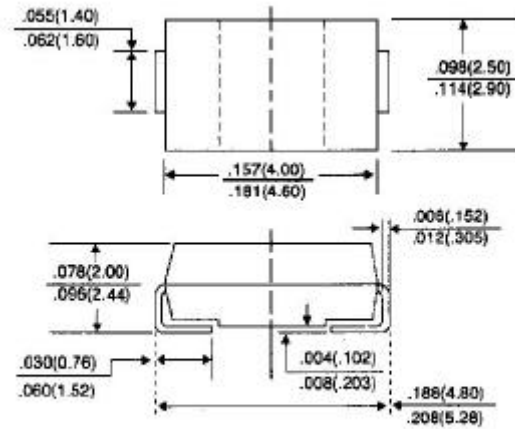

Dimensions in inches and (millimeters)

MECHANICAL DATA

Case: JEDEC DO-214AC molded plastic

Terminals: Solder plated, solderable per MIL-STD-750,
Method 2026

Polarity: Indicated by cathode band

Standard packaging: 12mm tape (EIA-481)

Weight: 0.002 ounce, 0.064 gram

MAXIMUM RATINGS AND ELECTRICAL CHARACTERISTICS

Ratings at 25 °C ambient temperature unless otherwise specified.

Single phase, half wave, 60 Hz, resistive or inductive load.

For capacitive load, derate current by 20%.

	SYMBOLS	GS1A	GS1B	GS1D	GS1G	GS1J	GS1K	GS1M	UNITS
Maximum Recurrent Peak Reverse Voltage	V_{RRM}	50	100	200	400	600	800	1000	Volts
Maximum RMS Voltage	V_{RMS}	35	70	140	280	420	560	700	Volts
Maximum DC Blocking Voltage	V_{DC}	50	100	200	400	600	800	1000	Volts
Maximum Average Forward Rectified Current, at $T_L=100$	$I_{(AV)}$	1.0							Amps
Peak Forward Surge Current 8.3ms single half sine-wave superimposed on rated load(JEDEC method)	I_{FSM}	30.0							Amps
Maximum Instantaneous Forward Voltage at 1.0A	V_F	1.10							Volts
Maximum DC Reverse Current $T_A=25$ At Rated DC Blocking Voltage $T_A=125$	I_R	5.0 50							A
Maximum Reverse Recovery Time (Note 1)	T_{RR}	2.5							S
Typical Junction capacitance (Note 2)	C_J	12							pF
Typical Thermal Resistance (Note 3)	R_{JL}	30.0							/W
Operating and Storage Temperature Range	T_J, T_{STG}	-55 to +150							

NOTES:

1. Reverse Recovery Test Conditions: $I_F=0.5A$, $I_R=1.0A$, $I_{rr}=0.25A$
2. Measured at 1.0 MHz and Applied $V_r=4.0$ volts

3. 8.0mm^2 (.013mm thick) land areas
 RATING AND CHARACTERISTIC CURVES
 GS1A THRU GS1M

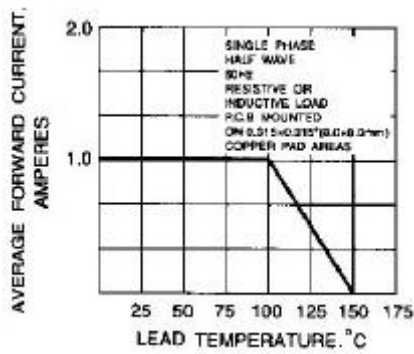

Fig. 1-FORWARD CURRENT DERATING CURVE

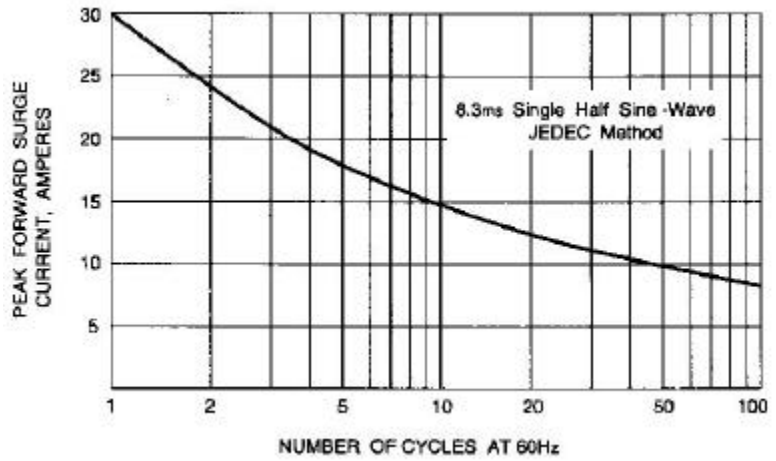

Fig. 2-MAXIMUM NON-REPETITIVE PEAK FORWARD SURGE CURRENT

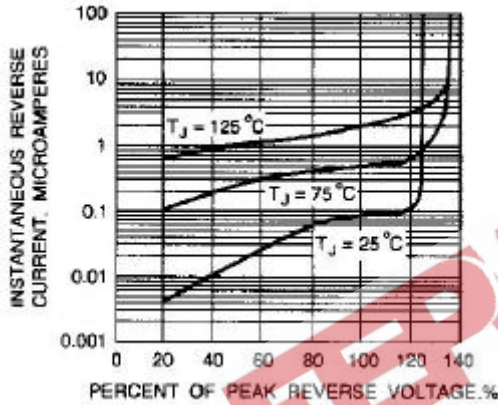

Fig. 3-TYPICAL REVERSE CHARACTERISTICS

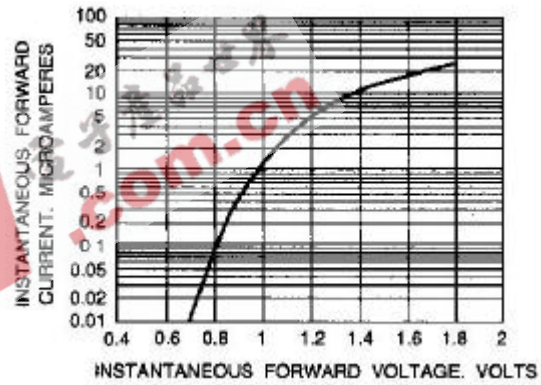

Fig. 4-TYPICAL INSTANTANEOUS FORWARD CHARACTERISTICS

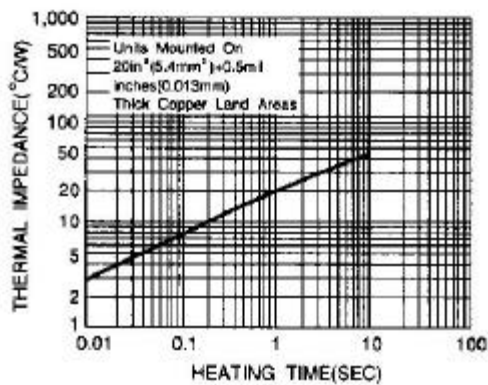

Fig. 5-TRANSIENT THERMAL IMPEDANCE

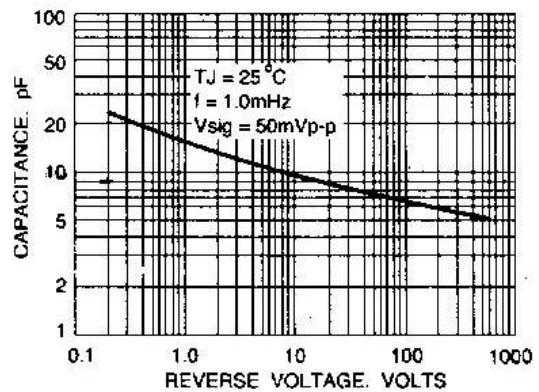

Fig. 6-TYPICAL JUNCTION CAPACITANCE