

# T-1 (3 mm) Diffused LED Lamps

## Technical Data

**HLMP-1301**  
**HLMP-1401**  
**HLMP-1503**  
**HLMP-K401**  
**HLMP-K600**

### Features

- **High Intensity**
- **Choice of 4 Bright Colors**  
 High Efficiency Red  
 Orange  
 Yellow  
 High Performance Green
- **Popular T-1 Diameter Package**
- **Selected Minimum Intensities**
- **Wide Viewing Angle**
- **General Purpose Leads**

- **Reliable and Rugged**
- **Available on Tape and Reel**

### Description

This family of T-1 lamps is widely used in general purpose indicator applications. Diffusants, tints, and optical design are balanced to yield superior light output and wide viewing angles. Several intensity choices are available in each color for increased design flexibility.



### Package Dimensions

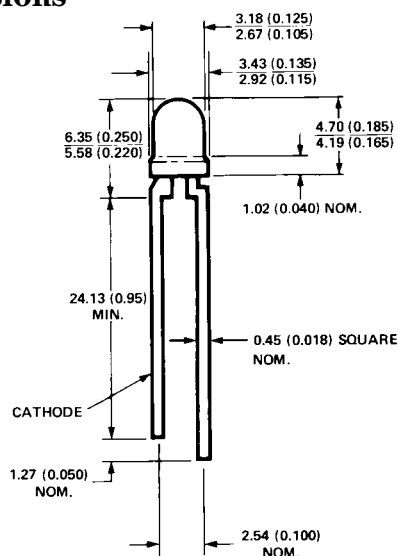

NOTES:  
 1. ALL DIMENSIONS ARE IN MILLIMETRES (INCHES).  
 2. AN EPOXY MENISCUS MAY EXTEND ABOUT 1mm (0.040") DOWN THE LEADS.

## Selection Guide

Material	Color	Part Number	Luminous Intensity $I_v$ (mcd) at 10 mA	
			Min.	Max.
GaAsP on GaP	Red	HLMP-1301	3.4	–
		HLMP-1301-E00xx	3.4	–
		HLMP-1301-FG0xx	5.4	17.2
		HLMP-1301-G00xx	8.6	–
		HLMP-1301-GH0xx	8.6	27.6
	Yellow	HLMP-1401	2.2	–
		HLMP-1401-D00xx	3.6	–
		HLMP-1401-E00xx	5.7	–
		HLMP-1401-EF0xx	5.7	18.4
		HLMP-1401-EFBxx	5.7	18.4
	Orange	HLMP-K401	2.1	–
		HLMP-K401-E00xx	3.4	–
		HLMP-K401-EF0xx	3.4	10.8
		HLMP-K401-FGDxx	5.4	17.2
GaP	Green	HLMP-1503	1.0	–
		HLMP-1503-C00xx	2.6	–
		HLMP-1503-D00xx	4.2	–
		HLMP-1503-DE0xx	4.2	13.4
		HLMP-1503-DEDxx	4.2	13.4
	Emerald Green <sup>[1]</sup>	HLMP-K600	1.0	–

**Note:**

1. Please refer to Application Note 1061 for information comparing standard green and emerald green light output degradation.

## Part Numbering System

HLMP - x x xx - x x x xx

### Mechanical Option

00: Bulk  
 01: Tape & Reel, Crimped Leads  
 02, Bx: Tape & Reel, Straight Leads  
 A1: Right Angle Housing, Uneven Leads  
 A2: Right Angle Housing, Even Leads  
 Dx, EE: Ammo Pack, Straight Leads  
 R4: Tape & Reel, Counter Clockwise  
 Vx: Ammo Pack, Horizontal Leads  
 FG: Products need inventory control for Customer IDI

### Color Bin Options

0: Full Color Bin Distribution  
 B: Color Bins 2 & 3 only  
 D: Color Bins 4 & 5 only

### Maximum Iv Bin Options

0: Open (no max. limit)  
 Others: Please refer to the Iv Bin Table

### Minimum Iv Bin Options

Please refer to the Iv Bin Table

### Color Options

3: GaP HER  
 4: GaP Yellow (except K4xx Series)  
 5: GaP Green  
 6: GaP Emerald Green

### Package Options

1: T-1 (3 mm)  
 K: T-1 (3 mm) Orange (K4xx) or Emerald Green (K6xx)

### Absolute Maximum Ratings at $T_A = 25^\circ\text{C}$

Parameter	HER/Orange	Yellow	Green	Units
Peak Forward Current	90	60	90	mA
Average Forward Current <sup>[1]</sup>	25	20	25	mA
DC Current <sup>[2]</sup>	30	20	30	mA
Reverse Voltage ( $I_R = 100 \mu\text{A}$ )	5	5	5	V
Transient Forward Current <sup>[4]</sup> (10 $\mu\text{sec}$ Pulse)	500	500	500	mA
LED Junction Temperature	110	110	110	$^\circ\text{C}$
Operating Temperature Range	-55 to +100	-55 to +100	-20 to +100	$^\circ\text{C}$
Storage Temperature Range			-55 to +100	
Lead Soldering Temperature [1.6 mm (0.063 in.) from body]	260 $^\circ\text{C}$ for 5 seconds			

**Notes:**

1. See Figure 5 (HER/Orange), 10 (Yellow), or 15 (Green/Emerald Green) to establish pulsed operating conditions.
2. For Red, Orange, and Green series derate linearly from 50 $^\circ\text{C}$  at 0.5 mA/ $^\circ\text{C}$ . For Yellow series derate linearly from 50 $^\circ\text{C}$  at 0.2 mA/ $^\circ\text{C}$ .
3. For Red, Orange, and Green series derate power linearly from 25 $^\circ\text{C}$  at 1.8 mW/ $^\circ\text{C}$ . For Yellow series derate power linearly from 50 $^\circ\text{C}$  at 1.6 mW/ $^\circ\text{C}$ .
4. The transient peak current is the maximum non-recurring peak current that can be applied to the device without damaging the LED die and wirebond. It is not recommended that the device be operated at peak currents beyond the peak forward current listed in the Absolute Maximum Ratings.

### Electrical Characteristics at $T_A = 25^\circ\text{C}$

Symbol	Description	Device HLMP-	Min.	Typ.	Max.	Units	Test Conditions
$2\theta^{1/2}$	Included Angle Between Half Luminous Intensity Points	All		60		Deg.	$I_F = 10\text{ mA}$ See Note 1
$\lambda_{PEAK}$	Peak Wavelength	High Efficiency Red Orange Yellow Green Emerald Green		635 600 583 565 558		nm	Measurement at Peak
$\lambda_d$	Dominant Wavelength	High Efficiency Red Orange Yellow Green Emerald Green		626 602 585 569 560		nm	See Note 2
$\Delta\lambda_{1/2}$	Spectral Line Halfwidth	High Efficiency Red Yellow Green Emerald Green		40 36 28 24		nm	
$\tau_s$	Speed of Response	High Efficiency Red Orange Yellow Green Emerald Green		90 280 90 500 3100		ns	
C	Capacitance	High Efficiency Red Orange Yellow Green Emerald Green		11 4 15 18 35		pF	$V_F = 0;$ $f = 1\text{ MHz}$
$R\theta_{J-PIN}$	Thermal Resistance	All		290		$^\circ\text{C/W}$	Junction to Cathode Lead
$V_F$	Forward Voltage	HER/Orange Yellow Green Emerald Green	1.5 1.5 1.5	1.9 2.0 2.1	2.4 2.4 2.7 2.7	V	$I_F = 10\text{ mA}$
$V_R$	Reverse Breakdown Voltage	All	5.0			V	$I_R = 100\text{ }\mu\text{A}$
$\eta_V$	Luminous Efficacy	High Efficiency Red Orange Yellow Green Emerald Green		145 380 500 595 655		$\frac{\text{lumens}}{\text{Watt}}$	See Note 3

#### Notes:

- $\theta^{1/2}$  is the off-axis angle at which the luminous intensity is half the axial luminous intensity.
- The dominant wavelength,  $\lambda_d$ , is derived from the CIE chromaticity diagram and represents the single wavelength which defines the color of the device.
- Radiant intensity,  $I_e$ , in watts/steradian, may be found from the equation  $I_e = I_v/\eta_v$ , where  $I_v$  is the luminous intensity in candelas and  $\eta_v$  is the luminous efficacy in lumens/watt.

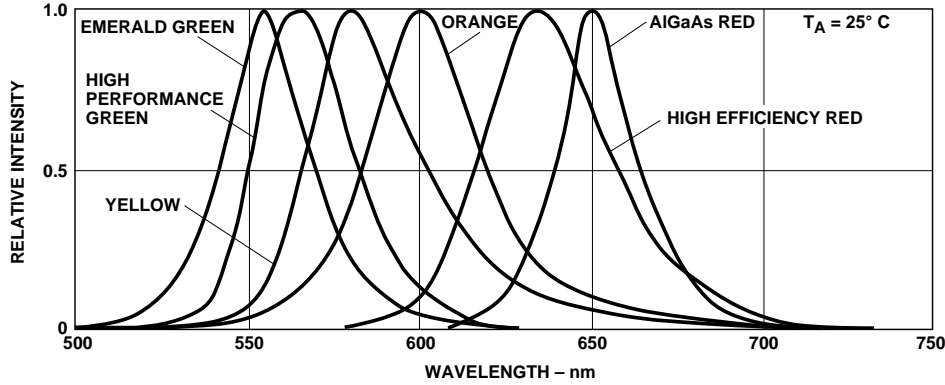

Figure 1. Relative Intensity vs. Wavelength.

### T-1 High Efficiency Red, Orange Diffused Lamps

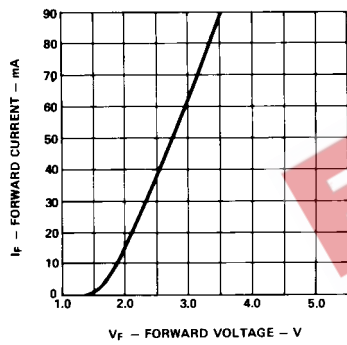

Figure 2. Forward Current vs. Forward Voltage Characteristics.

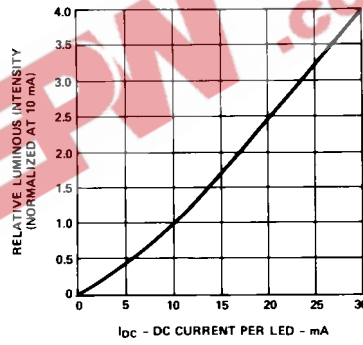

Figure 3. Relative Luminous Intensity vs. DC Forward Current.

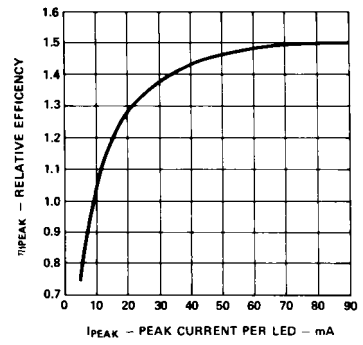

Figure 4. Relative Efficiency (Luminous Intensity per Unit Current) vs. Peak LED Current.

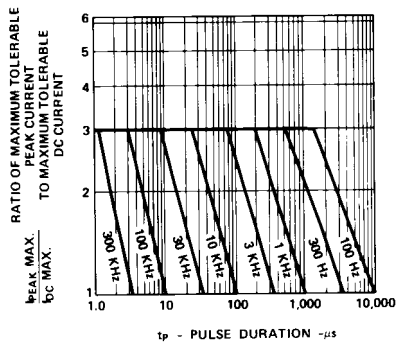

Figure 5. Maximum Tolerable Peak Current vs. Pulse Duration. ( $I_{DC}$  MAX as per MAX Ratings).

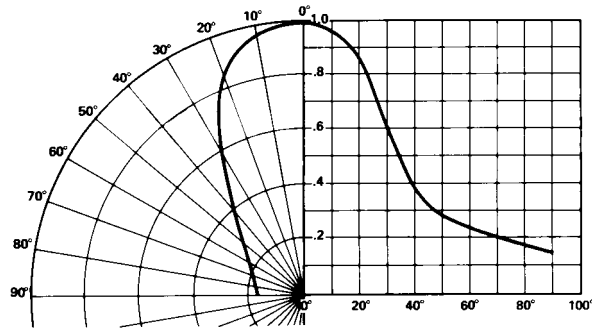

Figure 6. Relative Luminous Intensity vs. Angular Displacement.

### T-1 Yellow Diffused Lamps

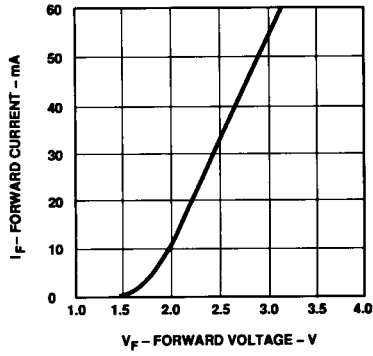

Figure 7. Forward Current vs. Forward Voltage Characteristics.

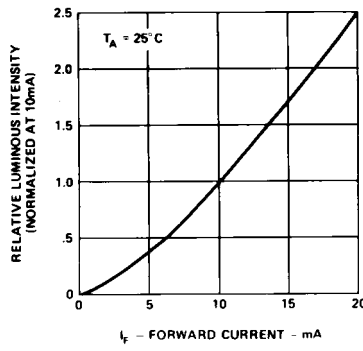

Figure 8. Relative Luminous Intensity vs. Forward Current.

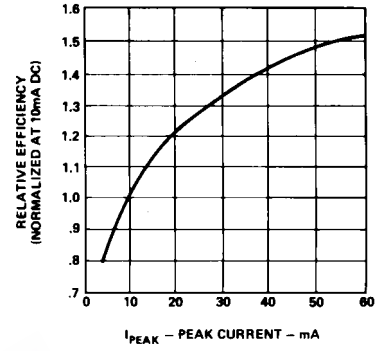

Figure 9. Relative Efficiency (Luminous Intensity per Unit Current) vs. Peak Current.

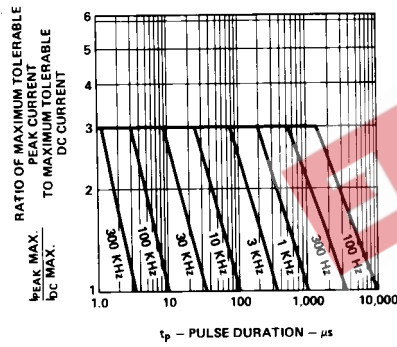

Figure 10. Maximum Tolerable Peak Current vs. Pulse Duration. ( $I_{DC}$  MAX as per MAX Ratings).

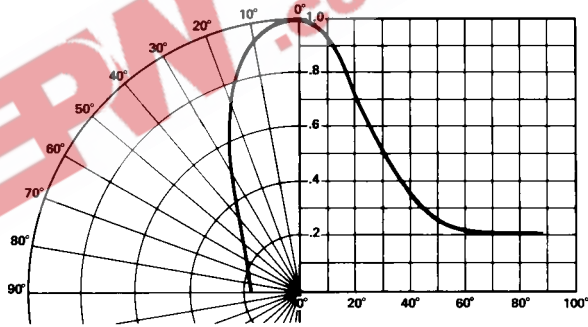

Figure 11. Relative Luminous Intensity vs. Angular Displacement.

### T-1 Green/Emerald Green Diffused Lamps

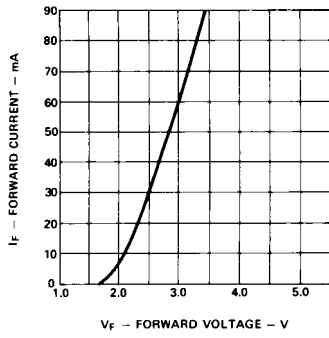

Figure 12. Forward Current vs. Forward Voltage Characteristics.

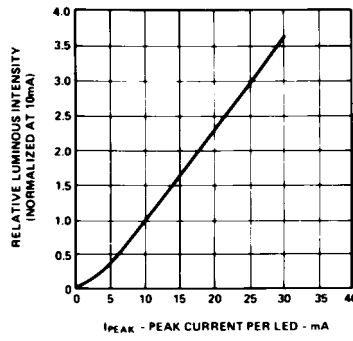

Figure 13. Relative Luminous Intensity vs. Forward Current.

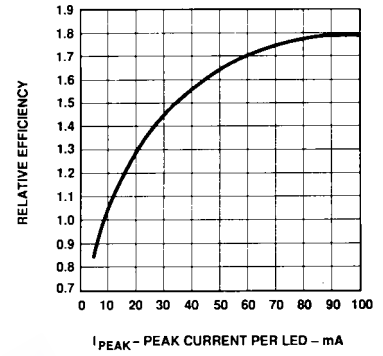

Figure 14. Relative Efficiency (Luminous Intensity per Unit Current) vs. Peak LED Current.

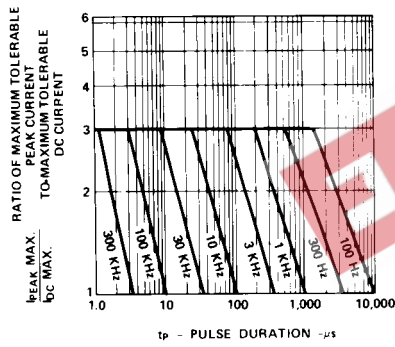

Figure 15. Maximum Tolerable Peak Current vs. Pulse Duration. ( $I_{DC}$  MAX as per MAX Ratings).

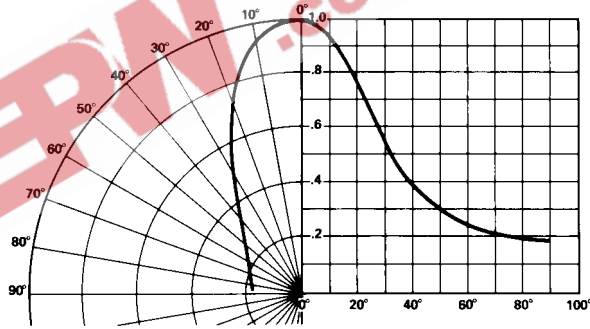

Figure 16. Relative Luminous Intensity vs. Angular Displacement.



**Intensity Bin Limits**

Color	Bin	Intensity Range (mcd)	
		Min.	Max.
Red/Orange	D	2.4	3.8
	E	3.8	6.1
	F	6.1	9.7
	G	9.7	15.5
	H	15.5	24.8
	I	24.8	39.6
	J	39.6	63.4
	K	63.4	101.5
	L	101.5	162.4
	M	162.4	234.6
	N	234.6	340.0
	O	340.0	540.0
	P	540.0	850.0
	Q	850.0	1200.0
	R	1200.0	1700.0
	S	1700.0	2400.0
	T	2400.0	3400.0
	U	3400.0	4900.0
	V	4900.0	7100.0
	W	7100.0	10200.0
X	10200.0	14800.0	
Y	14800.0	21400.0	
Z	21400.0	30900.0	
Yellow	C	2.5	4.0
	D	4.0	6.5
	E	6.5	10.3
	F	10.3	16.6
	G	16.6	26.5
	H	26.5	42.3
	I	42.3	67.7
	J	67.7	108.2
	K	108.2	173.2
	L	173.2	250.0
	M	250.0	360.0
	N	360.0	510.0
	O	510.0	800.0
	P	800.0	1250.0
	Q	1250.0	1800.0
	R	1800.0	2900.0
	S	2900.0	4700.0
T	4700.0	7200.0	
U	7200.0	11700.0	
V	11700.0	18000.0	
W	18000.0	27000.0	

**Intensity Bin Limits, continued**

Color	Bin	Intensity Range (mcd)	
		Min.	Max.
Green/ Emerald Green	A	1.1	1.8
	B	1.8	2.9
	C	2.9	4.7
	D	4.7	7.6
	E	7.6	12.0
	F	12.0	19.1
	G	19.1	30.7
	H	30.7	49.1
	I	49.1	78.5
	J	78.5	125.7
	K	125.7	201.1
	L	201.1	289.0
	M	289.0	417.0
	N	417.0	680.0
	O	680.0	1100.0
	P	1100.0	1800.0
	Q	1800.0	2700.0
	R	2700.0	4300.0
S	4300.0	6800.0	
T	6800.0	10800.0	
U	10800.0	16000.0	
V	16000.0	25000.0	
W	25000.0	40000.0	

Maximum tolerance for each bin limit is  $\pm 18\%$ .

### Color Categories

Color	Category #	Lambda (nm)	
		Min.	Max.
Emerald Green	9	522.5	555.5
	8	555.5	558.5
	7	558.5	561.5
	6	561.5	564.5
Green	6	561.5	564.5
	5	564.5	567.5
	4	567.5	570.5
	3	570.5	573.5
	2	573.5	576.5
Yellow	1	582.0	584.5
	3	584.5	587.0
	2	587.0	589.5
	4	589.5	592.0
	5	592.0	593.0
Orange	1	597.0	599.5
	2	599.5	602.0
	3	602.0	604.5
	4	604.5	607.5
	5	607.5	610.5
	6	610.5	613.5
	7	613.5	616.5
	8	616.5	619.5

Tolerance for each bin limit is  $\pm 0.5$  nm.

## Mechanical Option Matrix

Mechanical Option Code	Definition
00	Bulk Packaging, minimum increment 500 pcs/bag
01	Tape & Reel, crimped leads, minimum increment 1800 pcs/bag
02	Tape & Reel, straight leads, minimum increment 1800 pcs/bag
A1	Right Angle Housing, uneven leads, minimum increment 500 pcs/bag
A2	Right Angle Housing, even leads, minimum increment 500 pcs/bag
BG	Tape & Reel, straight leads in 2K increment
BJ	Tape & Reel, straight leads in 2K increment
DD	Ammo Pack, straight leads in 2K increment
DJ	Ammo Pack, straight leads in 2K increment
EE	Ammo Pack, straight leads in 5K increment
R4	Tape & Reel, straight leads, counter clockwise, anode lead leaving the reel first
VA	Ammo Pack, horizontal leads in 2K increment
VB	Ammo Pack, horizontal leads in 2K increment
FG	Inventory Control for Customer IDI

**Note:**

All categories are established for classification of products. Products may not be available in all categories. Please contact your local Agilent representative for further clarification/information.