

T-1 (3 mm) High Intensity LED Lamps

Technical Data

HLMP-132x Series
HLMP-142x Series
HLMP-152x Series

Features

- **High Intensity**
- **Choice of 3 Bright Colors**
High Efficiency Red
Yellow
High Performance Green
- **Popular T-1 Diameter Package**
- **Selected Minimum Intensities**
- **Narrow Viewing Angle**

- **General Purpose Leads**
- **Reliable and Rugged**
- **Available on Tape and Reel**
- **For more information, please refer to Tape and Reel Option Data Sheet**

Description

This family of T-1 lamps is specially designed for applications requiring higher on-axis intensity than is achievable with a standard lamp. The light generated is focused to a narrow beam to achieve this effect.



Package Dimensions

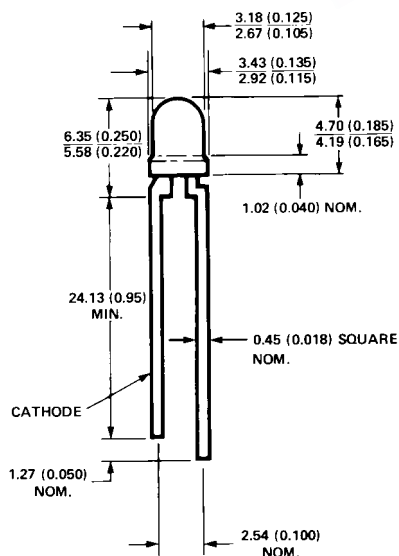

NOTES:
 1. ALL DIMENSIONS ARE IN MILLIMETRES (INCHES).
 2. AN EPOXY MENISCUS MAY EXTEND ABOUT 1mm (0.040") DOWN THE LEADS.

Selection Guide

| Part Number | Package Description | Color | Luminous Intensity Iv (mcd) @ 10 mA | |
|-----------------|--------------------------|---------------------|-------------------------------------|------|
| | | | Min. | Max. |
| HLMP-1320-G00xx | Untinted, Nondiffused | High Efficiency Red | 8.6 | — |
| HLMP-1320-GH0xx | | | 8.6 | 27.6 |
| HLMP-1321 | Tinted, Nondiffused | | 8.6 | — |
| HLMP-1321-G00xx | | | 8.6 | — |
| HLMP-1321-HI0xx | | 13.8 | 44.0 | |
| HLMP-1420 | Microtinted, Nondiffused | Yellow | 9.2 | — |
| HLMP-1420-F00xx | | | 9.2 | — |
| HLMP-1421 | Tinted, Nondiffused | | 9.2 | — |
| HLMP-1421-F00xx | | | 9.2 | — |
| HLMP-1421-FG0xx | | 9.2 | 29.4 | |
| HLMP-1520 | Microtinted, Nondiffused | Green | 6.7 | — |
| HLMP-1520-E00xx | | | 6.7 | — |
| HLMP-1521 | Tinted, Nondiffused | | 6.7 | — |
| HLMP-1521-E00xx | | | 6.7 | — |
| HLMP-1521-EF0xx | | | 6.7 | 21.2 |

Part Numbering System

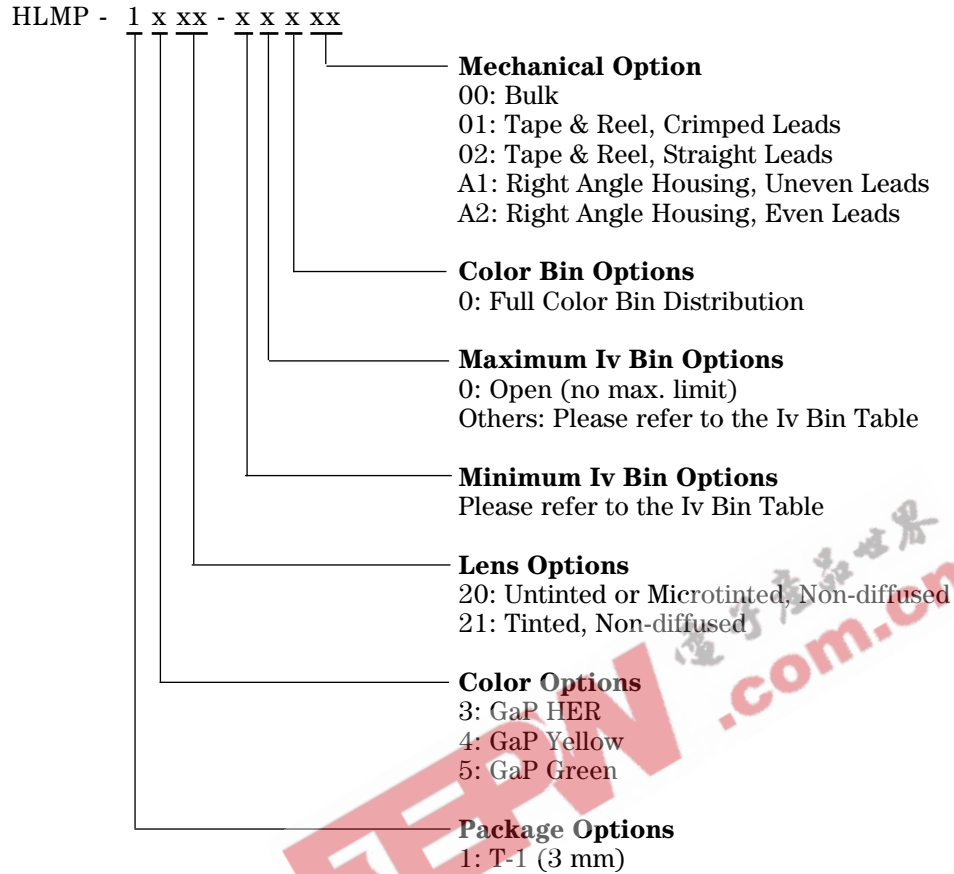

Absolute Maximum Ratings at $T_A = 25^\circ\text{C}$

| Parameter | Red | Yellow | Green | Units |
|--|------------------------------------|-------------|-------------|------------------|
| Peak Forward Current | 90 | 60 | 90 | mA |
| Average Forward Current ^[1] | 25 | 20 | 25 | mA |
| DC Current ^[2] | 30 | 20 | 30 | mA |
| Power Dissipation ^[3] | 135 | 85 | 135 | mW |
| Reverse Voltage ($I_R = 100 \mu\text{A}$) | 5 | 5 | 5 | V |
| Transient Forward Current ^[4] (10 μsec Pulse) | 500 | 500 | 500 | mA |
| LED Junction Temperature | 110 | 110 | 110 | $^\circ\text{C}$ |
| Operating Temperature Range | -55 to +100 | -55 to +100 | -20 to +100 | $^\circ\text{C}$ |
| Storage Temperature Range | | | -55 to +100 | |
| Lead Soldering Temperature [1.6 mm (0.063 in.) from body] | 260 $^\circ\text{C}$ for 5 seconds | | | |

Notes:

- See Figure 5 (Red), 10 (Yellow), or 15 (Green) to establish pulsed operating conditions.
- For Red and Green series derate linearly from 50 $^\circ\text{C}$ at 0.5 mA/ $^\circ\text{C}$. For Yellow series derate linearly from 50 $^\circ\text{C}$ at 0.2 mA/ $^\circ\text{C}$.
- For Red and Green series derate power linearly from 25 $^\circ\text{C}$ at 1.8 mW/ $^\circ\text{C}$. For Yellow series derate power linearly from 50 $^\circ\text{C}$ at 1.6 mW/ $^\circ\text{C}$.
- The transient peak current is the maximum non-recurring peak current that can be applied to the device without damaging the LED die and wirebond. It is not recommended that the device be operated at peak currents beyond the peak forward current listed in the Absolute Maximum Ratings.

Electrical Characteristics at $T_A = 25^\circ\text{C}$

| Symbol | Description | Device HLMP- | Min. | Typ. | Max. | Units | Test Conditions |
|-------------------------|--|-----------------|------------|------------|------------|--------------------|---|
| I_V | Luminous Intensity | 1320 1321 | 8.6 8.6 | 30 30 | | mcd | $I_F = 10\text{ mA}$ (Figure 3) |
| | | 1420 1421 | 9.2 9.2 | 15 15 | | mcd | $I_F = 10\text{ mA}$ (Figure 8) |
| | | 1520 1521 | 6.7 6.7 | 22 22 | | mcd | $I_F = 10\text{ mA}$ (Figure 3) |
| $2\theta^{1/2}$ | Including Angle Between Half Luminous Intensity Points | All | | 45 | | Deg. | $I_F = 10\text{ mA}$ See Note 1 (Figures 6, 11, 16, 21) |
| λ_{PEAK} | Peak Wavelength | 132x | | 635 | | nm | Measurement at Peak (Figure 1) |
| | | 142X 152X | | 583 565 | | | |
| $\Delta\lambda_{1/2}$ | Spectral Line Halfwidth | 132x | | 40 | | nm | |
| | | 142X 152X | | 36 28 | | | |
| λ_d | Dominant Wavelength | 132x | | 626 | | nm | See Note 2 (Figure 1) |
| | | 142X 152X | | 585 569 | | | |
| τ_s | Speed of Response | 132x | | 90 | | ns | |
| | | 142X 152X | | 90 500 | | | |
| C | Capacitance | 132x | | 11 | | pF | $V_F = 0$; $f = 1\text{ MHz}$ |
| | | 142X 152X | | 15 18 | | | |
| $R\theta_{J-PIN}$ | Thermal Resistance | All | | 290 | | $^\circ\text{C/W}$ | Junction to Cathode Lead |
| V_F | Forward Voltage | 132x | | 1.9 | 2.4 | V | $I_F = 10\text{ mA}$ |
| | | 142X 152X | | 2.0 2.1 | 2.4 2.7 | | |
| V_R | Reverse Breakdown Voltage | All | 5.0 | | | V | $I_R = 100\text{ }\mu\text{A}$ |
| η_V | Luminous Efficacy | 132x | | 145 | | lumens | See Note 3 |
| | | 142X 152X | | 500 595 | | Watt | |

Notes:

- $\theta^{1/2}$ is the off-axis angle at which the luminous intensity is half the axial luminous intensity.
- The dominant wavelength, λ_d , is derived from the CIE chromaticity diagram and represents the single wavelength which defines the color of the device.
- Radiant intensity, I_e , in watts/steradian, may be found from the equation $I_e = I_v/\eta_v$, where I_v is the luminous intensity in candelas and η_v is the luminous efficacy in lumens/watt.



Figure 1. Relative Intensity vs. Wavelength.

T-1 High Efficiency Red Non-Diffused

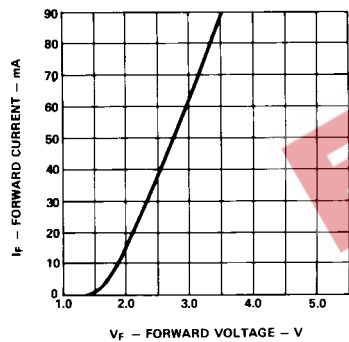

Figure 2. Forward Current vs. Forward Voltage Characteristics.



Figure 3. Relative Luminous Intensity vs. DC Forward Current.



Figure 4. Relative Efficiency (Luminous Intensity per Unit Current) vs. Peak LED Current.



Figure 5. Maximum Tolerable Peak Current vs. Pulse Duration. (I_{DC} MAX as per MAX Ratings).



Figure 6. Relative Luminous Intensity vs. Angular Displacement.

T-1 Yellow Non-Diffused

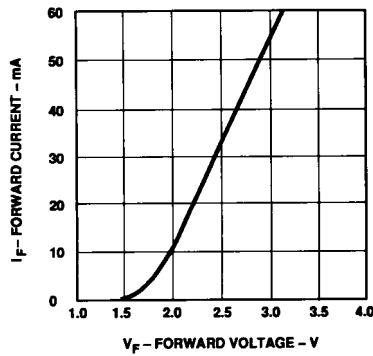

Figure 7. Forward Current vs. Forward Voltage Characteristics.



Figure 8. Relative Luminous Intensity vs. Forward Current.

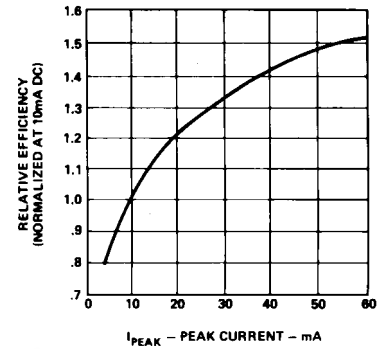

Figure 9. Relative Efficiency (Luminous Intensity per Unit Current) vs. Peak Current.



Figure 10. Maximum Tolerable Peak Current vs. Pulse Duration. ($I_{DC}MAX$ as per MAX Ratings).

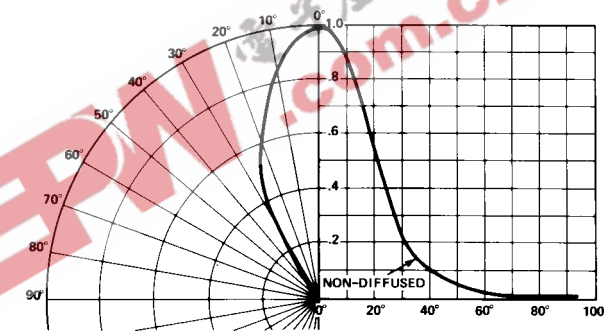

Figure 11. Relative Luminous Intensity vs. Angular Displacement.

T-1 Green Non-Diffused



Figure 12. Forward Current vs. Forward Voltage Characteristics.



Figure 13. Relative Luminous Intensity vs. Forward Current.

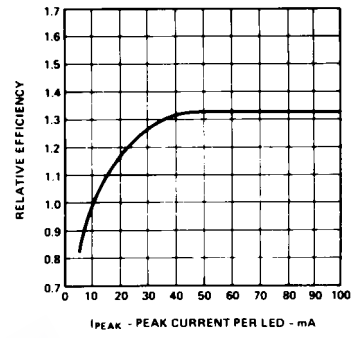

Figure 14. Relative Efficiency (Luminous Intensity per Unit Current) vs. Peak LED Current.

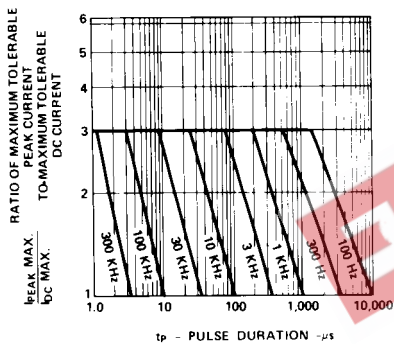

Figure 15. Maximum Tolerable Peak Current vs. Pulse Duration. (I_{DCMAX} as per MAX Ratings).

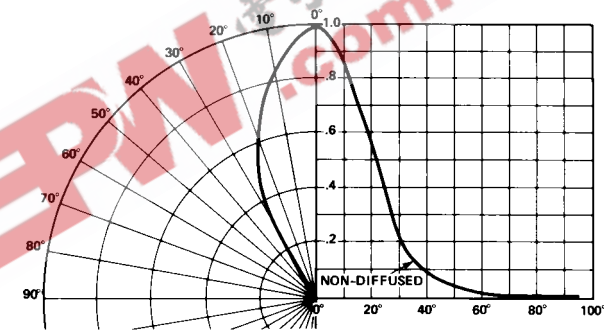

Figure 16. Relative Luminous Intensity vs. Angular Displacement.

Intensity Bin Limits

| Color | Bin | Intensity Range (mcd) | |
|--------|---------|-----------------------|---------|
| | | Min. | Max. |
| Red | G | 9.7 | 15.5 |
| | H | 15.5 | 24.8 |
| | I | 24.8 | 39.6 |
| | J | 39.6 | 63.4 |
| | K | 63.4 | 101.5 |
| | L | 101.5 | 162.4 |
| | M | 162.4 | 234.6 |
| | N | 234.6 | 340.0 |
| | O | 340.0 | 540.0 |
| | P | 540.0 | 850.0 |
| | Q | 850.0 | 1200.0 |
| | R | 1200.0 | 1700.0 |
| | S | 1700.0 | 2400.0 |
| | T | 2400.0 | 3400.0 |
| | U | 3400.0 | 4900.0 |
| | V | 4900.0 | 7100.0 |
| | W | 7100.0 | 10200.0 |
| | X | 10200.0 | 14800.0 |
| | Y | 14800.0 | 21400.0 |
| | Z | 21400.0 | 30900.0 |
| Yellow | F | 10.3 | 16.6 |
| | G | 16.6 | 26.5 |
| | H | 26.5 | 42.3 |
| | I | 42.3 | 67.7 |
| | J | 67.7 | 108.2 |
| | K | 108.2 | 173.2 |
| | L | 173.2 | 250.0 |
| | M | 250.0 | 360.0 |
| | N | 360.0 | 510.0 |
| | O | 510.0 | 800.0 |
| | P | 800.0 | 1250.0 |
| | Q | 1250.0 | 1800.0 |
| | R | 1800.0 | 2900.0 |
| | S | 2900.0 | 4700.0 |
| | T | 4700.0 | 7200.0 |
| | U | 7200.0 | 11700.0 |
| V | 11700.0 | 18000.0 | |
| W | 18000.0 | 27000.0 | |

Intensity Bin Limits, continued

| Color | Bin | Intensity Range (mcd) | |
|-------|---------|-----------------------|---------|
| | | Min. | Max. |
| Green | E | 7.6 | 12.0 |
| | F | 12.0 | 19.1 |
| | G | 19.1 | 30.7 |
| | H | 30.7 | 49.1 |
| | I | 49.1 | 78.5 |
| | J | 78.5 | 125.7 |
| | K | 125.7 | 201.1 |
| | L | 201.1 | 289.0 |
| | M | 289.0 | 417.0 |
| | N | 417.0 | 680.0 |
| | O | 680.0 | 1100.0 |
| | P | 1100.0 | 1800.0 |
| | Q | 1800.0 | 2700.0 |
| | R | 2700.0 | 4300.0 |
| | S | 4300.0 | 6800.0 |
| | T | 6800.0 | 10800.0 |
| | U | 10800.0 | 16000.0 |
| V | 16000.0 | 25000.0 | |
| W | 25000.0 | 40000.0 | |

Maximum tolerance for each bin limit is $\pm 18\%$.

Color Categories

| Color | Category # | Lambda (nm) | |
|--------|------------|-------------|-------|
| | | Min. | Max. |
| Green | 6 | 561.5 | 564.5 |
| | 5 | 564.5 | 567.5 |
| | 4 | 567.5 | 570.5 |
| | 3 | 570.5 | 573.5 |
| | 2 | 573.5 | 576.5 |
| Yellow | 1 | 582.0 | 584.5 |
| | 3 | 584.5 | 587.0 |
| | 2 | 587.0 | 589.5 |
| | 4 | 589.5 | 592.0 |
| | 5 | 592.0 | 593.0 |

Maximum tolerance for each bin limit is ± 0.5 nm.

Mechanical Option Matrix

| Mechanical Option Code | Definition |
|------------------------|--|
| 00 | Bulk Packaging, minimum increment 500 pcs/bag |
| 01 | Tape & Reel, crimped leads, minimum increment 1800 pcs/bag |
| 02 | Tape & Reel, straight leads, minimum increment 1800 pcs/bag |
| A1 | Right Angle Housing, uneven leads, minimum increment 500 pcs/bag |
| A2 | Right Angle Housing, even leads, minimum increment 500 pcs/bag |

Note:

All categories are established for classification of products. Products may not be available in all categories. Please contact your local Agilent representative for further clarification/information.