

# T-1 (3 mm) High Intensity LED Lamps

## Technical Data

**HLMP-132x Series**  
**HLMP-142x Series**  
**HLMP-152x Series**

### Features

- **High Intensity**
- **Choice of 3 Bright Colors**  
High Efficiency Red  
Yellow  
High Performance Green
- **Popular T-1 Diameter Package**
- **Selected Minimum Intensities**
- **Narrow Viewing Angle**

- **General Purpose Leads**
- **Reliable and Rugged**
- **Available on Tape and Reel**
- **For more information, please refer to Tape and Reel Option Data Sheet**

### Description

This family of T-1 lamps is specially designed for applications requiring higher on-axis intensity than is achievable with a standard lamp. The light generated is focused to a narrow beam to achieve this effect.



### Package Dimensions

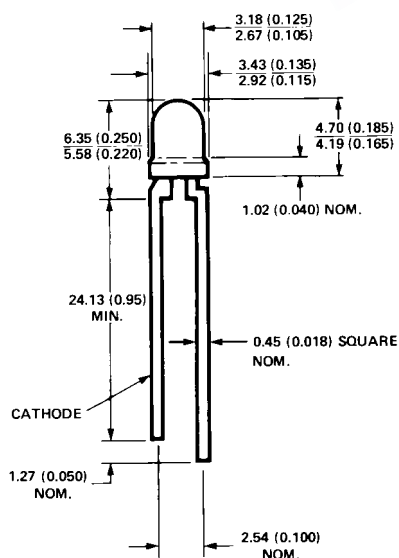

NOTES:  
 1. ALL DIMENSIONS ARE IN MILLIMETRES (INCHES).  
 2. AN EPOXY MENISCUS MAY EXTEND ABOUT 1mm (0.040") DOWN THE LEADS.

### Selection Guide

Part Number	Package Description	Color	Luminous Intensity Iv (mcd) @ 10 mA	
			Min.	Max.
HLMP-1320-G00xx	Untinted, Nondiffused	High Efficiency Red	8.6	—
HLMP-1320 GH0xx			8.6	27.6
HLMP-1321	Tinted, Nondiffused		8.6	—
HLMP-1321-G00xx			8.6	—
HLMP-1321-HI0xx		13.8	44.0	
HLMP-1420	Microtinted, Nondiffused	Yellow	9.2	—
HLMP-1420-F00xx			9.2	—
HLMP-1421	Tinted, Nondiffused		9.2	—
HLMP-1421-F00xx			9.2	—
HLMP-1421-FG0xx		9.2	29.4	
HLMP-1520	Microtinted, Nondiffused	Green	6.7	—
HLMP-1520-E00xx			6.7	—
HLMP-1521	Tinted, Nondiffused		6.7	—
HLMP-1521-E00xx			6.7	—
HLMP-1521-EF0xx			6.7	21.2

## Part Numbering System

HLMP - 1 x xx - x x x xx

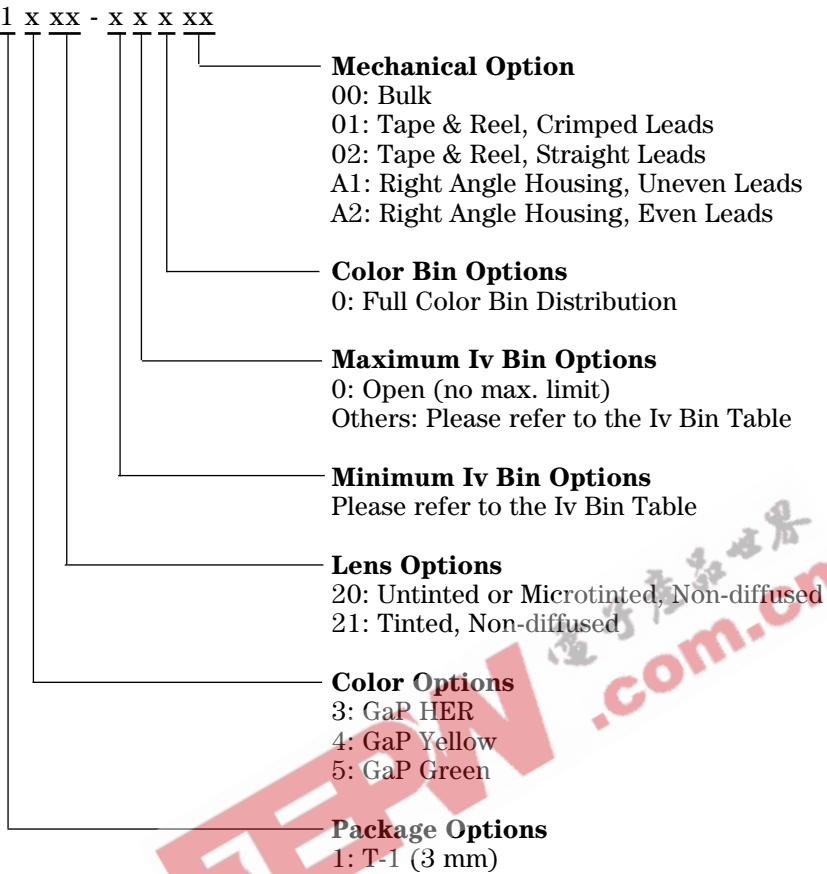

## Absolute Maximum Ratings at $T_A = 25^\circ\text{C}$

Parameter	Red	Yellow	Green	Units
Peak Forward Current	90	60	90	mA
Average Forward Current <sup>[1]</sup>	25	20	25	mA
DC Current <sup>[2]</sup>	30	20	30	mA
Power Dissipation <sup>[3]</sup>	135	85	135	mW
Reverse Voltage ( $I_R = 100 \mu\text{A}$ )	5	5	5	V
Transient Forward Current <sup>[4]</sup> (10 $\mu\text{sec}$ Pulse)	500	500	500	mA
LED Junction Temperature	110	110	110	$^\circ\text{C}$
Operating Temperature Range	-55 to +100	-55 to +100	-20 to +100	$^\circ\text{C}$
Storage Temperature Range			-55 to +100	
Lead Soldering Temperature [1.6 mm (0.063 in.) from body]	260 $^\circ\text{C}$ for 5 seconds			

### Notes:

- See Figure 5 (Red), 10 (Yellow), or 15 (Green) to establish pulsed operating conditions.
- For Red and Green series derate linearly from 50 $^\circ\text{C}$  at 0.5 mA/ $^\circ\text{C}$ . For Yellow series derate linearly from 50 $^\circ\text{C}$  at 0.2 mA/ $^\circ\text{C}$ .
- For Red and Green series derate power linearly from 25 $^\circ\text{C}$  at 1.8 mW/ $^\circ\text{C}$ . For Yellow series derate power linearly from 50 $^\circ\text{C}$  at 1.6 mW/ $^\circ\text{C}$ .
- The transient peak current is the maximum non-recurring peak current that can be applied to the device without damaging the LED die and wirebond. It is not recommended that the device be operated at peak currents beyond the peak forward current listed in the Absolute Maximum Ratings.

### Electrical Characteristics at $T_A = 25^\circ\text{C}$

Symbol	Description	Device HLMP-	Min.	Typ.	Max.	Units	Test Conditions
$I_V$	Luminous Intensity	1320 1321	8.6 8.6	30 30		mcd	$I_F = 10\text{ mA}$ (Figure 3)
		1420 1421	9.2 9.2	15 15		mcd	$I_F = 10\text{ mA}$ (Figure 8)
		1520 1521	6.7 6.7	22 22		mcd	$I_F = 10\text{ mA}$ (Figure 3)
$2\theta^{1/2}$	Including Angle Between Half Luminous Intensity Points	All		45		Deg.	$I_F = 10\text{ mA}$ See Note 1 (Figures 6, 11, 16, 21)
$\lambda_{\text{PEAK}}$	Peak Wavelength	132x		635		nm	Measurement at Peak (Figure 1)
		142X 152X		583 565			
$\Delta\lambda_{1/2}$	Spectral Line Halfwidth	132x		40		nm	
		142X 152X		36 28			
$\lambda_d$	Dominant Wavelength	132x		626		nm	See Note 2 (Figure 1)
		142X 152X		585 569			
$\tau_s$	Speed of Response	132x		90		ns	
		142X 152X		90 500			
C	Capacitance	132x		11		pF	$V_F = 0$ ; $f = 1\text{ MHz}$
		142X 152X		15 18			
$R\theta_{J-PIN}$	Thermal Resistance	All		290		$^\circ\text{C/W}$	Junction to Cathode Lead
$V_F$	Forward Voltage	132x		1.9	2.4	V	$I_F = 10\text{ mA}$
		142X 152X		2.0 2.1	2.4 2.7		
$V_R$	Reverse Breakdown Voltage	All	5.0			V	$I_R = 100\text{ }\mu\text{A}$
$\eta_V$	Luminous Efficacy	132x		145		lumens	See Note 3
		142X 152X		500 595		Watt	

#### Notes:

- $\theta^{1/2}$  is the off-axis angle at which the luminous intensity is half the axial luminous intensity.
- The dominant wavelength,  $\lambda_d$ , is derived from the CIE chromaticity diagram and represents the single wavelength which defines the color of the device.
- Radiant intensity,  $I_e$ , in watts/steradian, may be found from the equation  $I_e = I_v/\eta_v$ , where  $I_v$  is the luminous intensity in candelas and  $\eta_v$  is the luminous efficacy in lumens/watt.

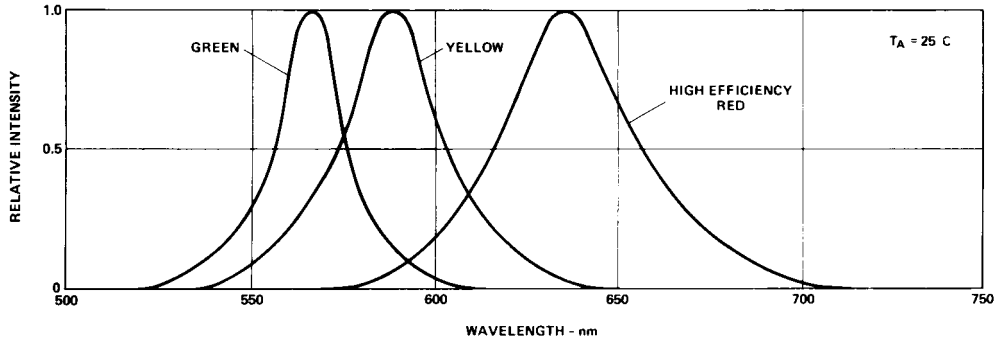

Figure 1. Relative Intensity vs. Wavelength.

### T-1 High Efficiency Red Non-Diffused

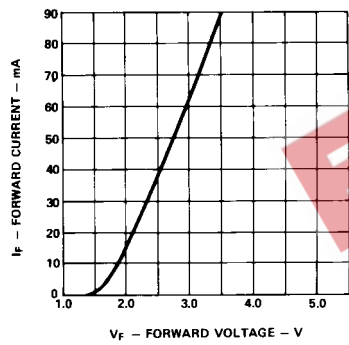

Figure 2. Forward Current vs. Forward Voltage Characteristics.

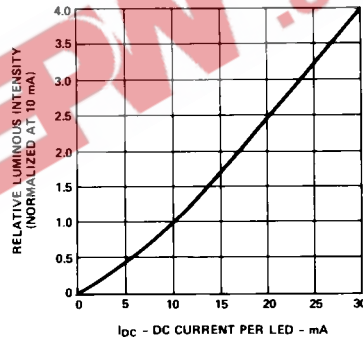

Figure 3. Relative Luminous Intensity vs. DC Forward Current.

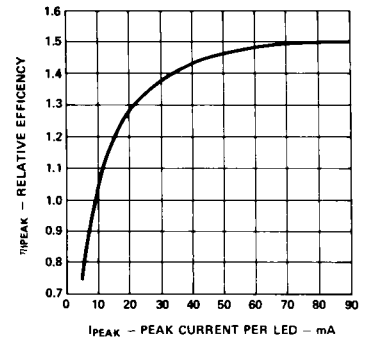

Figure 4. Relative Efficiency (Luminous Intensity per Unit Current) vs. Peak LED Current.

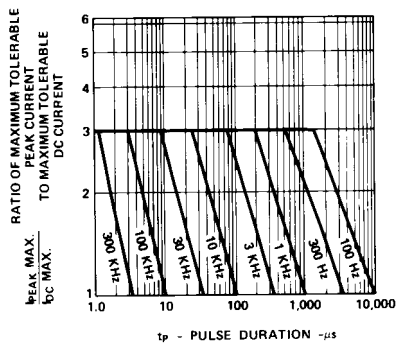

Figure 5. Maximum Tolerable Peak Current vs. Pulse Duration. ( $I_{DC}$  MAX as per MAX Ratings).

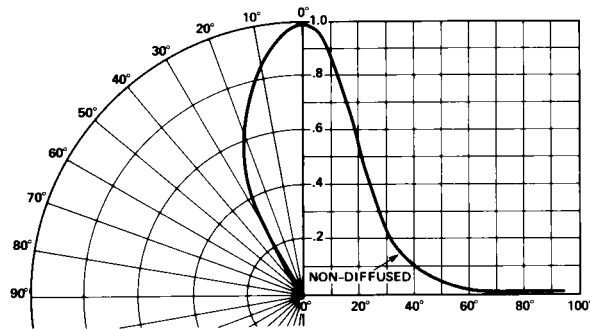

Figure 6. Relative Luminous Intensity vs. Angular Displacement.

## T-1 Yellow Non-Diffused

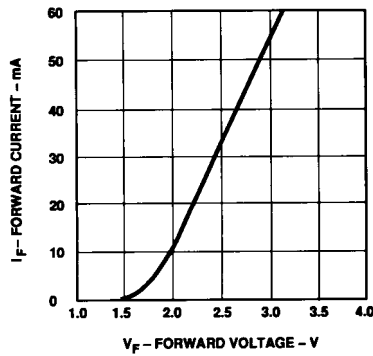

Figure 7. Forward Current vs. Forward Voltage Characteristics.

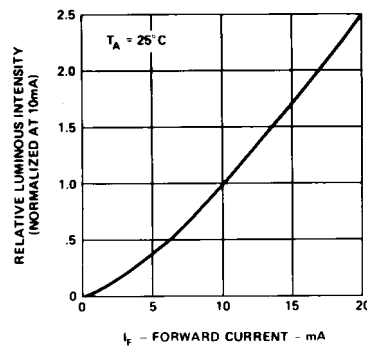

Figure 8. Relative Luminous Intensity vs. Forward Current.

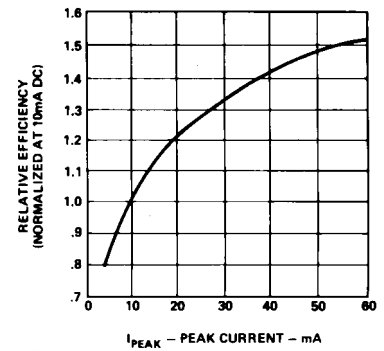

Figure 9. Relative Efficiency (Luminous Intensity per Unit Current) vs. Peak Current.

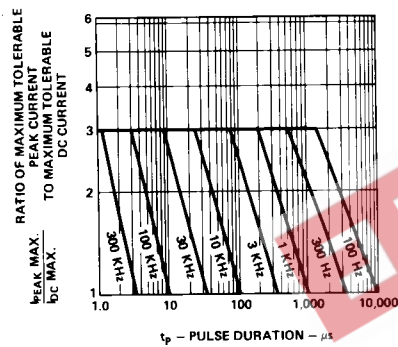

Figure 10. Maximum Tolerable Peak Current vs. Pulse Duration. ( $I_{DC}MAX$  as per MAX Ratings).

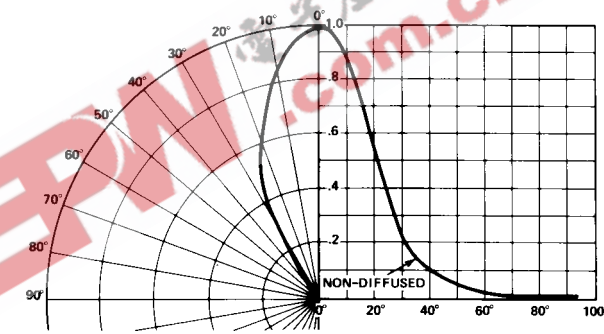

Figure 11. Relative Luminous Intensity vs. Angular Displacement.

### T-1 Green Non-Diffused

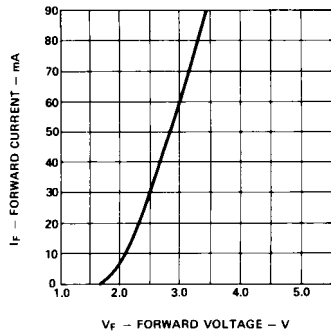

Figure 12. Forward Current vs. Forward Voltage Characteristics.

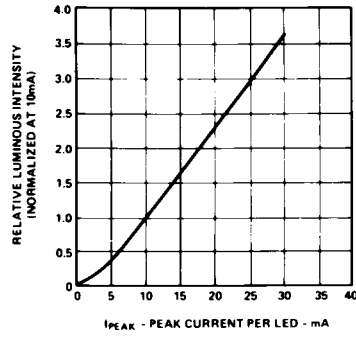

Figure 13. Relative Luminous Intensity vs. Forward Current.

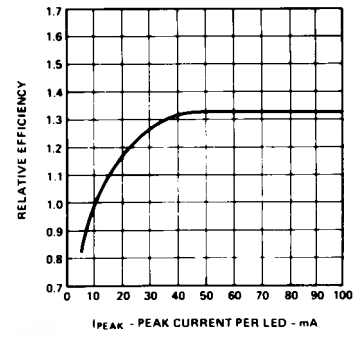

Figure 14. Relative Efficiency (Luminous Intensity per Unit Current) vs. Peak LED Current.

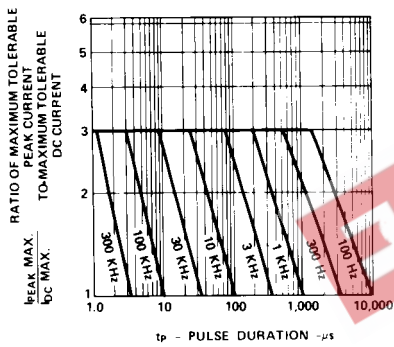

Figure 15. Maximum Tolerable Peak Current vs. Pulse Duration. ( $I_{DCMAX}$  as per MAX Ratings).

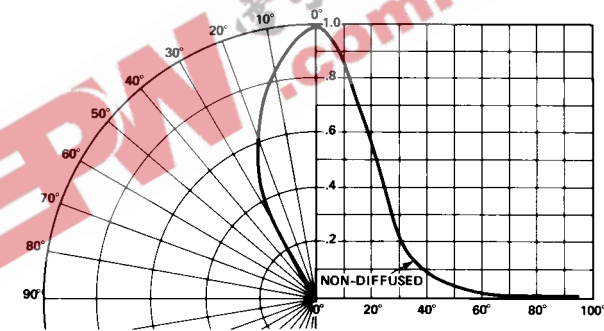

Figure 16. Relative Luminous Intensity vs. Angular Displacement.

**Intensity Bin Limits**

Color	Bin	Intensity Range (mcd)	
		Min.	Max.
Red	G	9.7	15.5
	H	15.5	24.8
	I	24.8	39.6
	J	39.6	63.4
	K	63.4	101.5
	L	101.5	162.4
	M	162.4	234.6
	N	234.6	340.0
	O	340.0	540.0
	P	540.0	850.0
	Q	850.0	1200.0
	R	1200.0	1700.0
	S	1700.0	2400.0
	T	2400.0	3400.0
	U	3400.0	4900.0
	V	4900.0	7100.0
	W	7100.0	10200.0
	X	10200.0	14800.0
	Y	14800.0	21400.0
	Z	21400.0	30900.0
Yellow	F	10.3	16.6
	G	16.6	26.5
	H	26.5	42.3
	I	42.3	67.7
	J	67.7	108.2
	K	108.2	173.2
	L	173.2	250.0
	M	250.0	360.0
	N	360.0	510.0
	O	510.0	800.0
	P	800.0	1250.0
	Q	1250.0	1800.0
	R	1800.0	2900.0
	S	2900.0	4700.0
	T	4700.0	7200.0
	U	7200.0	11700.0
V	11700.0	18000.0	
W	18000.0	27000.0	

**Intensity Bin Limits, continued**

Color	Bin	Intensity Range (mcd)	
		Min.	Max.
Green	E	7.6	12.0
	F	12.0	19.1
	G	19.1	30.7
	H	30.7	49.1
	I	49.1	78.5
	J	78.5	125.7
	K	125.7	201.1
	L	201.1	289.0
	M	289.0	417.0
	N	417.0	680.0
	O	680.0	1100.0
	P	1100.0	1800.0
	Q	1800.0	2700.0
	R	2700.0	4300.0
	S	4300.0	6800.0
	T	6800.0	10800.0
	U	10800.0	16000.0
V	16000.0	25000.0	
W	25000.0	40000.0	

Maximum tolerance for each bin limit is  $\pm 18\%$ .

### Color Categories

Color	Category #	Lambda (nm)	
		Min.	Max.
Green	6	561.5	564.5
	5	564.5	567.5
	4	567.5	570.5
	3	570.5	573.5
	2	573.5	576.5
Yellow	1	582.0	584.5
	3	584.5	587.0
	2	587.0	589.5
	4	589.5	592.0
	5	592.0	593.0

Maximum tolerance for each bin limit is  $\pm 0.5$  nm.

### Mechanical Option Matrix

Mechanical Option Code	Definition
00	Bulk Packaging, minimum increment 500 pcs/bag
01	Tape & Reel, crimped leads, minimum increment 1800 pcs/bag
02	Tape & Reel, straight leads, minimum increment 1800 pcs/bag
A1	Right Angle Housing, uneven leads, minimum increment 500 pcs/bag
A2	Right Angle Housing, even leads, minimum increment 500 pcs/bag

**Note:**

All categories are established for classification of products. Products may not be available in all categories. Please contact your local Agilent representative for further clarification/information.