

T-1 (3 mm) Diffused LED Lamps

Technical Data

HLMP-130X Series
HLMP-1385
HLMP-140X Series
HLMP-1485
HLMP-1503
HLMP-1523
HLMP-1585
HLMP-K40X Series
HLMP-K600

Features

- **High Intensity**
- **Choice of 4 Bright Colors**
High Efficiency Red
Orange
Yellow
High Performance Green
- **Popular T-1 Diameter Package**
- **Selected Minimum Intensities**
- **Wide Viewing Angle**
- **General Purpose Leads**

- **Reliable and Rugged**
- **Available on Tape and Reel**

Description

This family of T-1 lamps is widely used in general purpose indicator applications. Diffusants, tints, and optical design are balanced to yield superior light output and wide viewing angles. Several intensity choices are available in each color for increased design flexibility.



Package Dimensions

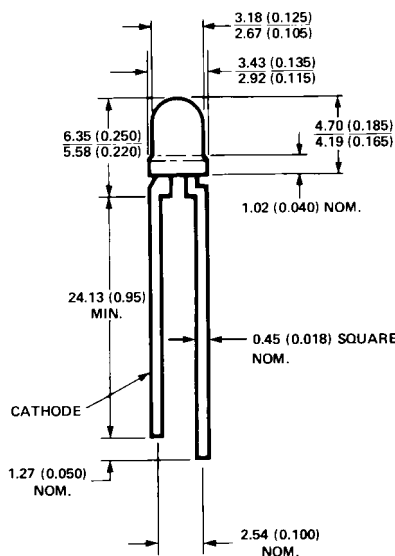

NOTES:
 1. ALL DIMENSIONS ARE IN MILLIMETRES (INCHES).
 2. AN EPOXY MENISCUS MAY EXTEND ABOUT 1mm (0.040") DOWN THE LEADS.

Part Number HLMP-	Application	Minimum Intensity (mcd) at 10 mA	Color (Material)
1300	General Purpose	1.3	High Efficiency Red (GaAsP on GaP)
1301	General Purpose	2.1	
1302	High Ambient	3.4	
1385	Premium Lamp	8.6	Orange (GaAsP on GaP)
K400	General Purpose	1.3	
K401	High Ambient	2.1	
K402	Premium Lamp	3.4	Yellow (GaAsP on GaP)
1400	General Purpose	1.4	
1401	General Purpose	2.2	
1402	High Ambient	3.6	Green (GaP)
1485	Premium Lamp	5.7	
1503	General Purpose	1.0	
1523	High Ambient	2.6	Emerald Green (GaP)
1585	Premium Lamp	4.2	
K600 ^[1]	General Purpose	1.0	

Note:

1. Please refer to Application Note 1061 for information comparing standard green and emerald green light output degradation.

Absolute Maximum Ratings at $T_A = 25^\circ\text{C}$

Parameter	HER/Orange	Yellow	Green	Units
Peak Forward Current	90	60	90	mA
Average Forward Current ^[1]	25	20	25	mA
DC Current ^[2]	30	20	30	mA
Reverse Voltage ($I_R = 100 \mu\text{A}$)	5	5	5	V
Transient Forward Current ^[4] (10 μsec Pulse)	500	500	500	mA
LED Junction Temperature	110	110	110	$^\circ\text{C}$
Operating Temperature Range	-55 to +100	-55 to +100	-20 to +100	$^\circ\text{C}$
Storage Temperature Range			-55 to +100	
Lead Soldering Temperature [1.6 mm (0.063 in.) from body]	260 $^\circ\text{C}$ for 5 seconds			

Notes:

- See Figure 5 (HER/Orange), 10 (Yellow), or 15 (Green/Emerald Green) to establish pulsed operating conditions.
- For Red, Orange, and Green series derate linearly from 50 $^\circ\text{C}$ at 0.5 mA/ $^\circ\text{C}$. For Yellow series derate linearly from 50 $^\circ\text{C}$ at 0.2 mA/ $^\circ\text{C}$.
- For Red, Orange, and Green series derate power linearly from 25 $^\circ\text{C}$ at 1.8 mW/ $^\circ\text{C}$. For Yellow series derate power linearly from 50 $^\circ\text{C}$ at 1.6 mW/ $^\circ\text{C}$.
- The transient peak current is the maximum non-recurring peak current that can be applied to the device without damaging the LED die and wirebond. It is not recommended that the device be operated at peak currents beyond the peak forward current listed in the Absolute Maximum Ratings.

Electrical Characteristics at $T_A = 25^\circ\text{C}$

Symbol	Description	Device HLMP-	Min.	Typ.	Max.	Units	Test Conditions	
I_V	Luminous Intensity	High Efficiency Red				mcd	$I_F = 10 \text{ mA}$	
		1300	1.3	5.0				
		1301	2.1	5.5				
		1302	3.4	7.0				
		1385	8.6	11.0				
		Orange						
		K400	1.3	5.0				
		K401	2.1	5.5				
		K402	3.4	7.0				
		Yellow						
		1400	1.4	5.0				
		1401	2.2	6.0				
		1402	3.6	7.0				
		1485	5.7	10.0				
		Green						
		1503	1.0	5.0				
1523	2.6	7.0						
1585	4.2	8.5						
Emerald Green								
K600	1.0	4.5						

Electrical Characteristics at T_A = 25°C (cont.)

Symbol	Description	Device HLMP-	Min.	Typ.	Max.	Units	Test Conditions
2θ ^{1/2}	Included Angle Between Half Luminous Intensity Points	All		60		Deg.	I _F = 10 mA See Note 1
λ _{PEAK}	Peak Wavelength	High Efficiency Red Orange Yellow Green Emerald Green		635 600 583 565 558		nm	Measurement at Peak
λ _d	Dominant Wavelength	High Efficiency Red Orange Yellow Green Emerald Green		626 602 585 569 560		nm	See Note 2
Δλ _{1/2}	Spectral Line Halfwidth	High Efficiency Red Yellow Green Emerald Green		40 36 28 24		nm	
τ _s	Speed of Response	High Efficiency Red Orange Yellow Green Emerald Green		90 280 90 500 3100		ns	
C	Capacitance	High Efficiency Red Orange Yellow Green Emerald Green		11 4 15 18 35		pF	V _F = 0; f = 1 MHz
Rθ _{J-PIN}	Thermal Resistance	All		290		°C/W	Junction to Cathode Lead
V _F	Forward Voltage	HER/Orange Yellow Green Emerald Green	1.5 1.5 1.5	1.9 2.0 2.1 2.1	2.4 2.4 2.7 2.7	V	I _F = 10 mA
V _R	Reverse Breakdown Voltage	All	5.0			V	I _R = 100 μA
η _V	Luminous Efficacy	High Efficiency Red Orange Yellow Green Emerald Green		145 380 500 595 655		$\frac{\text{lumens}}{\text{Watt}}$	See Note 3

Notes:

1. θ^{1/2} is the off-axis angle at which the luminous intensity is half the axial luminous intensity.
2. The dominant wavelength, λ_d, is derived from the CIE chromaticity diagram and represents the single wavelength which defines the color of the device.
3. Radiant intensity, I_e, in watts/steradian, may be found from the equation I_e = I_v/η_v, where I_v is the luminous intensity in candelas and η_v is the luminous efficacy in lumens/watt.

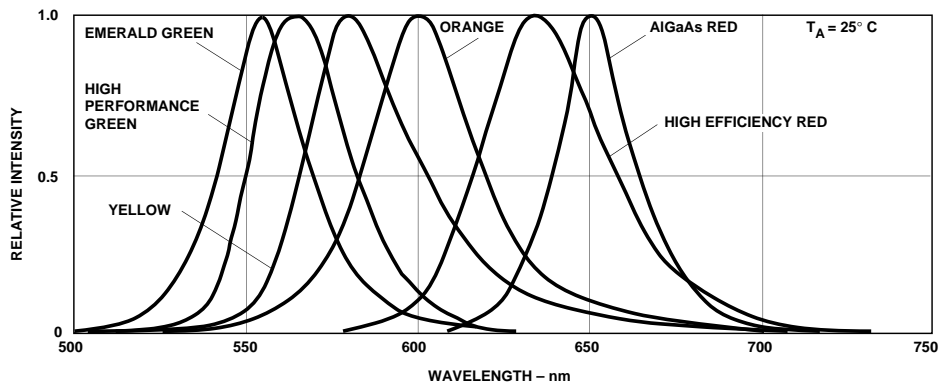

Figure 1. Relative Intensity vs. Wavelength.

T-1 High Efficiency Red, Orange Diffused Lamps

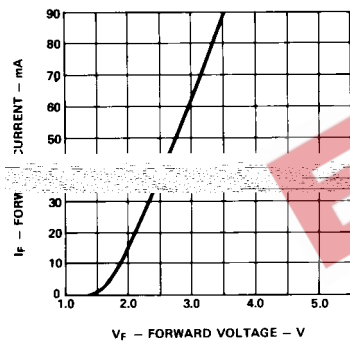

Figure 2. Forward Current vs. Forward Voltage Characteristics.

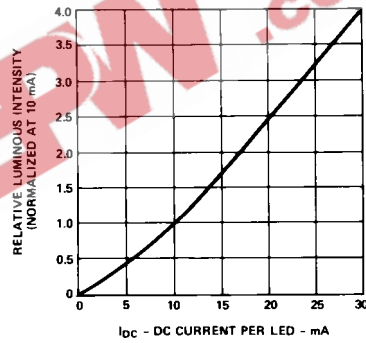

Figure 3. Relative Luminous Intensity vs. DC Forward Current.

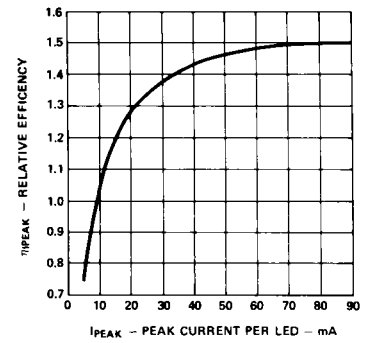

Figure 4. Relative Efficiency (Luminous Intensity per Unit Current) vs. Peak LED Current.

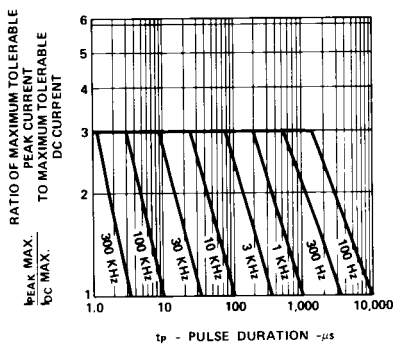

Figure 5. Maximum Tolerable Peak Current vs. Pulse Duration. (I_{DC} MAX as per MAX Ratings).

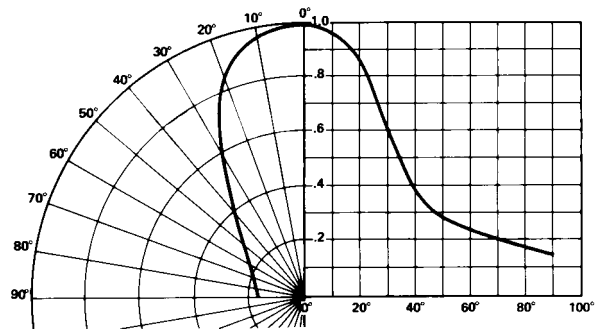

Figure 6. Relative Luminous Intensity vs. Angular Displacement.

T-1 Yellow Diffused Lamps

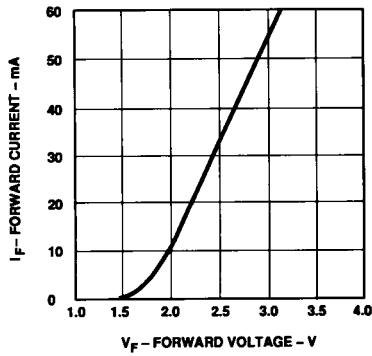

Figure 7. Forward Current vs. Forward Voltage Characteristics.

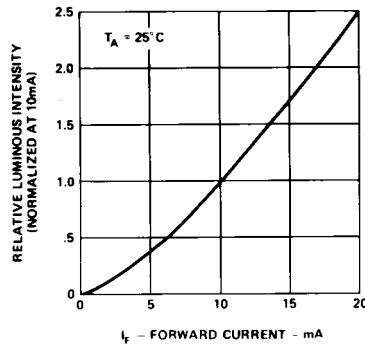

Figure 8. Relative Luminous Intensity vs. Forward Current.

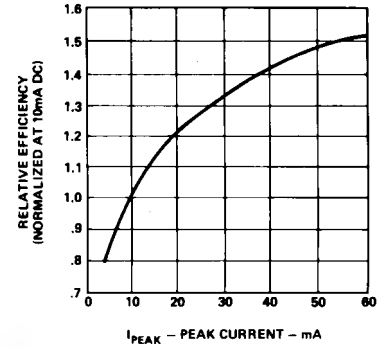

Figure 9. Relative Efficiency (Luminous Intensity per Unit Current) vs. Peak Current.

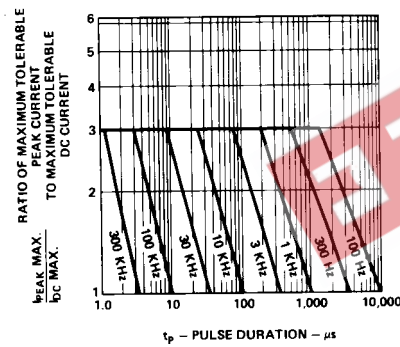

Figure 10. Maximum Tolerable Peak Current vs. Pulse Duration. (I_{DC} MAX as per MAX Ratings).

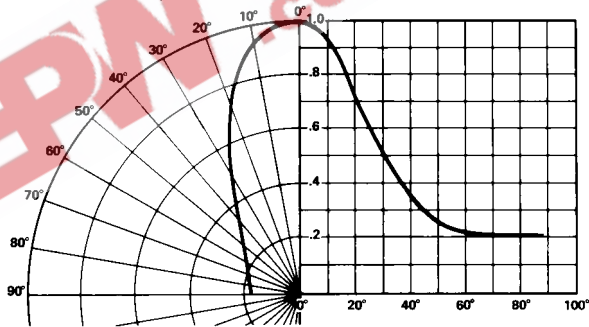

Figure 11. Relative Luminous Intensity vs. Angular Displacement.

T-1 Green/Emerald Green Diffused Lamps

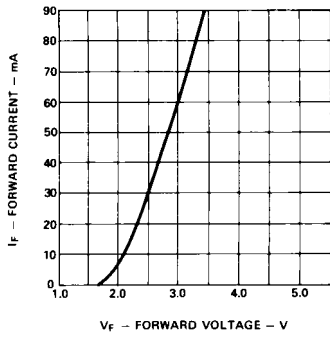

Figure 12. Forward Current vs. Forward Voltage Characteristics.

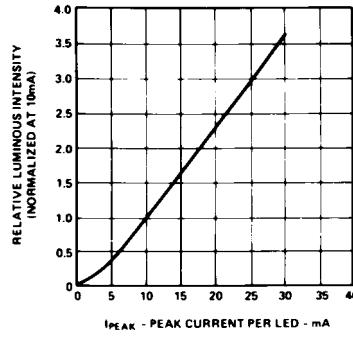

Figure 13. Relative Luminous Intensity vs. Forward Current.

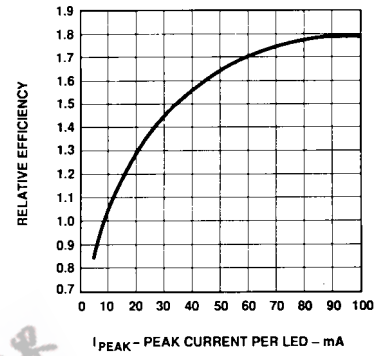

Figure 14. Relative Efficiency (Luminous Intensity per Unit Current) vs. Peak LED Current.

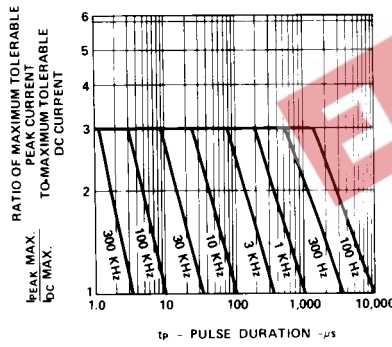

Figure 15. Maximum Tolerable Peak Current vs. Pulse Duration. (I_{DC} MAX as per MAX Ratings).

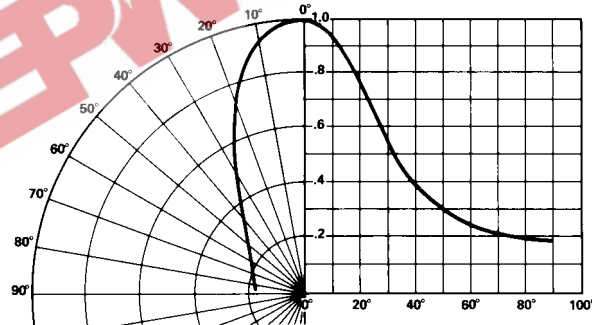

Figure 16. Relative Luminous Intensity vs. Angular Displacement.