

Frequency Timing Generator for EtherNet & Hard Drives

General Description

The **ICS9120-56** is a high performance frequency generator designed to support hard disk drive and EtherNet systems. It offers all clock frequencies required for the servo and decoder sections of these devices. These frequencies are synthesized from a single 25.00 MHz on-chip oscillator.

High accuracy, low jitter PLLs meet the 100 ppm frequency tolerance required by these systems. Fast output clock edge rates minimize board induced jitter.

Features

- Single 25.00 MHz crystal or system clock reference
- 100ps one sigma jitter maintains 16-bit performance
- Output rise/fall times less than 2.0ns
- On-chip loop filter components
- 3.3V-5V supply range
- 8-pin, 150-mil SOIC

Applications

- Specifically designed to support the high performance requirements of high speed EtherNet systems using 10Base-T/100Base-TX Integrated PHYceiver.
- Designed to support the requirements for high performance hard drives.

Pin Configuration

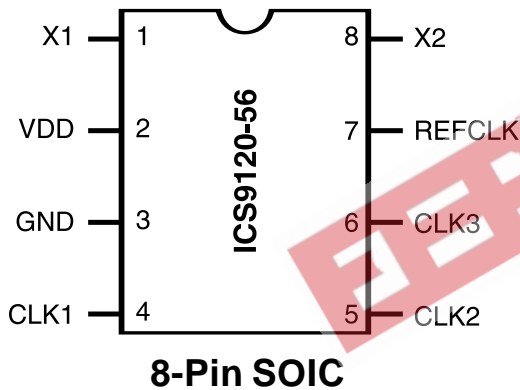

Block Diagram

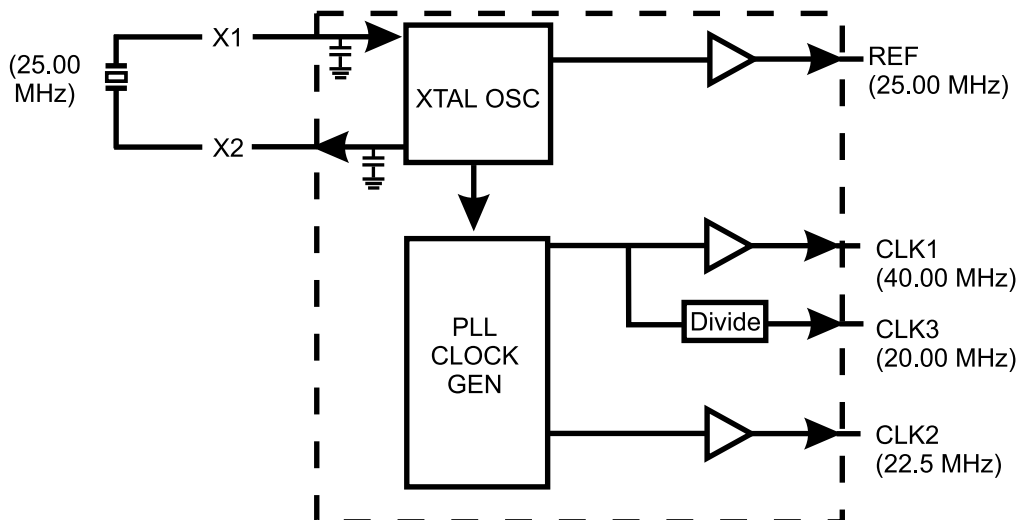

ICS9120-56

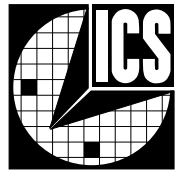

Pin Descriptions for ICS9120-56

PIN NUMBER	PIN NAME	TYPE	DESCRIPTION
1	X1	Input	Crystal or external clock source. Has feedback bias for crystal, and internal crystal load capacitors to GND.
2	VDD	Power	+Power supply input.
3	GND	Power	Ground return for Pin 2.
4	CLK1	Output	40.00 MHz clock output.
5	CLK2	Output	22.5 MHz output clock.
6	CLK3	Output	20.00 MHz output clock.
7	REF	Output	Reference clock
8	X2	Output	Crystal output drive, includes internal crystal load capacitor to GND.

EEPW 电子产品网 .com.cn

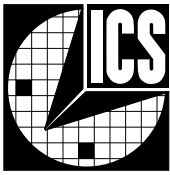

Absolute Maximum Ratings

Supply Voltage 7.0 V
 Logic Inputs GND -0.5 V to V_{DD} +0.5 V
 Ambient Operating Temperature 0°C to +70°C
 Storage Temperature -65°C to +150°C

Stresses above those listed under *Absolute Maximum Ratings* may cause permanent damage to the device. These ratings are stress specifications only and functional operation of the device at these or any other conditions above those listed in the operational sections of the specifications is not implied. Exposure to absolute maximum rating conditions for extended periods may affect product reliability.

Electrical Characteristics at 3.3V

V_{DD} = +3.0 to +3.7 V, T_A = 0°C-70°C unless otherwise stated

DC Characteristics						
PARAMETER	SYMBOL	TEST CONDITIONS	MIN	TYP	MAX	UNITS
Input Low Voltage ¹ , X1 ²	V _{IL}				0.8	V
Input High Voltage ¹ , X1 ²	V _{IH}		2.0			V
Output Low Voltage	V _{OL}	I _{OL} =6.0mA		0.05V _{DD}	0.1V _{DD}	V
Output High Voltage	V _{OH}	I _{OH} =4.0mA	0.85V _{DD}	0.94V _{DD}		V
Output Low Current	I _{OL}	V _{OL} =0.2V _{DD}	15.0	24		mA
Output High Current	I _{OH}	V _{OH} =0.7V _{DD}		-13	-8.0	mA
Supply Current	I _{DD}	Unloaded V _{DD} 5.5V		16	30.0	mA
AC Characteristics						
Rise Time ¹	T _r	15pF load 0.8 to 2.0V			2.3	ns
Fall Time ¹	T _f	15pF load 2.0 to 0.8V		0.8	1.5	ns
Duty Cycle ¹	D _t	15pF load @ 1.5V V _{DD} Except REFCLK	45	50	55	%
Duty Cycle ¹	D _t	15pF load @ 1.5V V _{DD} Except REFCLK	55	6	65	%
Jitter, One Sigma ¹	T _{jis}	For all frequencies except REFCLK		120	200	ps
Jitter Absolute ¹	T _{jab}	For all frequencies except REFCLK	-500	310	500	ps
Jitter, One Sigma ¹	T _{jis}	REFCLK only		0.9	3	%
Jitter Absolute ¹	T _{jab}	REFCLK only		1.9	4	%
Input Frequency ¹	F _I		1		30	MHz
Output Frequency Range ¹	F _O		1.6		48	MHz
Output Mean Frequency ¹ Accuracy vs. Target	F _{oa}	With 25.00MHz input	-100	0	100	ppm
Power-up Time ^{1,3}	T _{pu}	0 to 40.0 MHz/1ms Ramp.		7	10	ms
Crystal Input Capacitance ¹	C _{inx}	X1 (Pin 1), X2 (Pin 8)		16		pF

- 1: Parameter is guaranteed by design and characterization. Not 100% tested in production.
- 2: For direct drive of X1 input.
- 3. 1ms Ramp @ 1.4V to 1st crossing.

ICS9120-56

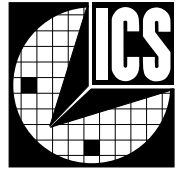

Electrical Characteristics at 5.0 V

$V_{DD} = +4.5$ to 5.5 V, $T_A = 0^{\circ}\text{C}$ - 70°C unless otherwise stated

DC Characteristics						
PARAMETER	SYMBOL	TEST CONDITIONS	MIN	TYP	MAX	UNITS
Input Low Voltage ¹ , X1 ²	V _{IL}				0.8	V
Input High Voltage ¹ , X1 ²	V _{IH}		2.0			V
Output Low Voltage	V _{OL}	I _{OL} =10mA		0.15	0.4	V
Output High Voltage	V _{OH}	I _{OH} =-30mA	2.4	3.7		V
Output Low Current	I _{OL}	V _{OL} =0.8	25	45		mA
Output High Current	I _{OH}	V _{OH} =2.4		-53	-35	mA
Supply Current	I _{DD}	Unloaded V _{DD} 5.5V		25	50	mA
AC Characteristics						
Rise Time ¹	T _r	15pF load 0.8 to 2.0V		0.7	1.5	ns
Fall Time ¹	T _f	15pF load 2.0 to 0.8V		0.5	1.5	ns
Rise Time ¹	T _r	15pF load 20% to 80%		2.0	4.0	
Fall Time ¹	T _f	15pF load 80% to 20%		1.4	4.0	
Duty Cycle ¹	D _t	15pF load @ 1.4V REFCLK	45	51	55	%
Duty Cycle ¹	D _t	15pF load @ 1.4V REFCLK	55	62	65	%
Jitter, One Sigma ¹	T _{jis}	For all frequencies except REFCLK		50	100	ps
Jitter Absolute ¹	T _{jab}	For all frequencies except REFCLK	-400	200	400	ps
Jitter, One Sigma ¹	T _{jis}	REFCLK only		1.2	4	%
Jitter Absolute ¹	T _{jab}	REFCLK only		2.2	5	%
Input Frequency ¹	F _I		1		50	MHz
Output Frequency Range ¹	F _O		1.6		80	MHz
Output Mean Frequency ¹ Accuracy vs. Target	F _{oa}	With 25.00MHz input	-100	0	100	ppm
Power-up Time ^{1,3}	T _{pu}	0 to 40.0 MHz; 1ms Ramp.		6	10	ms
Crystal Input Capacitance ¹	C _{inx}	X1 (Pin 1), X2 (Pin 8)		16		pF

1: Parameter is guaranteed by design and characterization. Not 100% tested in production.

2: For direct drive of X1 input.

3. 1ms Ramp @ 1.4V to 1st crossing.

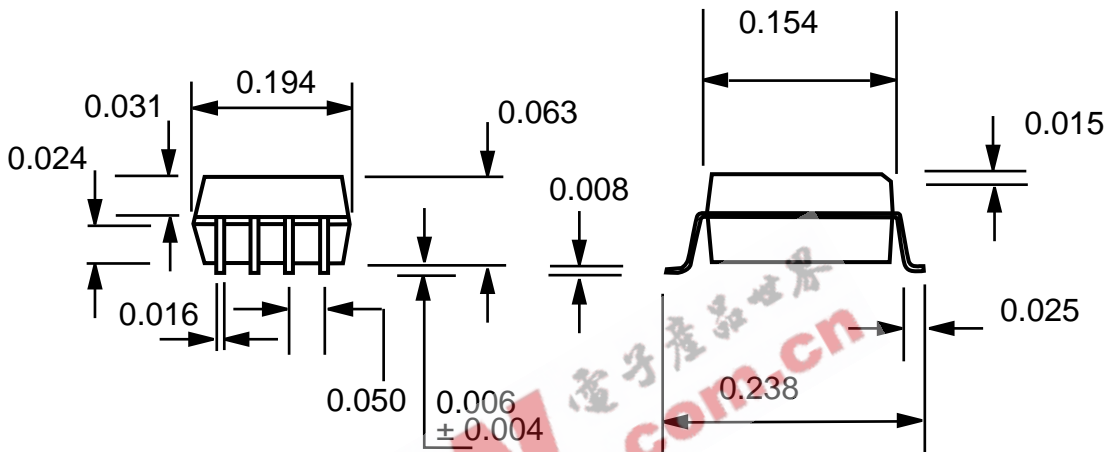
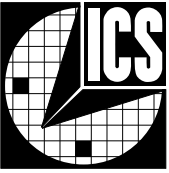

8-Pin SOIC Package

Ordering Information

ICS9120M-56

Example:

ICS XXXX M-PPP

