



Modem and Audio Clock Generator

General Description

The ICS9120-47 is a high performance frequency generator designed to support digital compact disk drive systems. It offers all clock frequencies required for the servo and decoder sections of these devices. These frequencies are synthesized from a single 16.9344 MHz on-chip oscillator.

High accuracy, low jitter PLLs meet the 150 ppm frequency tolerance required by these systems. Fast output clock edge rates minimize board induced jitter.

Unlike competitive devices, the ICS9120-47 operates over the entire 3.0-5.5V range.

Features

- Generates the output clock frequencies required by CD-ROM drive systems
- Single 16.9344 MHz crystal or system clock reference
- 100ps one sigma jitter
- Output rise/fall times less than 2.0ns (at 5V VDD)
- On-chip loop filter components
- 3.0V-5.5V supply range
- 150 ppm output frequency accuracy
- 8-pin, 150-mil SOIC

Applications

- Specifically designed to support CD-ROM drive requirements of multimedia applications

Block Diagram

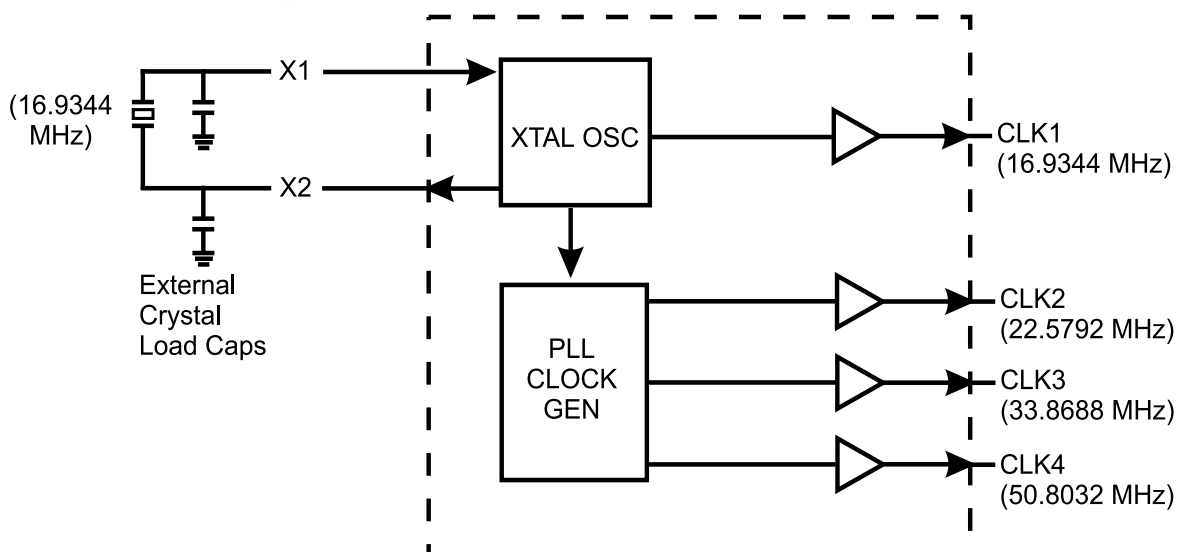

ICS9120-47

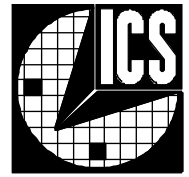

Pin Configuration

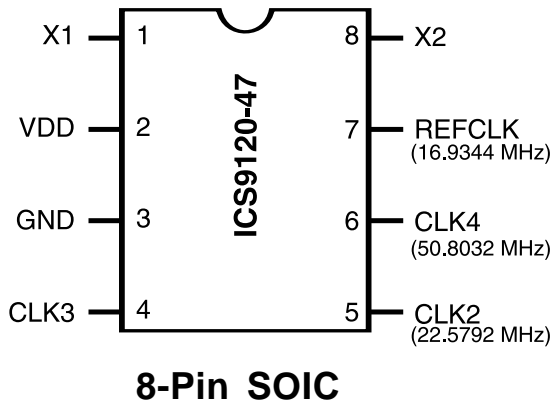

External Components/Crystal Selection

The ICS9120-47 incorporates a crystal oscillator circuit designed to provide 50% duty cycle over a range of operating conditions, including the addition of external crystal load capacitors to pins X1 and X2.

For the crystal oscillator, the crystal load capacitance must be connected externally by adding a capacitor from each of the X1 and X2 pins to ground. A parallel resonant 16.9344 MHz crystal is recommended.

Duty cycle is also maintained when using an external clock source (connected to X1, X2 left unconnected) as long as the external clock has good duty cycle.



Pin Descriptions for ICS9120-47

PIN NUMBER	PIN NAME	TYPE	DESCRIPTION
1	X1	Input	Crystal or external clock source. Has feedback bias for crystal. Nominally 16.9344 MHz input applied. (No internal load cap; must connect external load cap to ground for crystal oscillator).
2	VDD	Power	+Power supply input.
3	GND	Power	Ground return for Pin 2.
4	CLK3	Output	33.8688 MHz target output clock (with nominal 16.9344 MHz input).
5	CLK2	Output	22.5792 MHz target output clock (with nominal 16.9344 MHz input).
6	CLK4	Output	50.8032 MHz target output clock (with nominal 16.9344 MHz input).
7	REFCLK	Output	16.9344 MHz reference clock buffered output (with nominal 16.9344 MHz input).
8	X2	Output	Crystal output drive (leave this pin unconnected when using an external clock). (No internal load cap; must connect external load cap to ground for crystal oscillator).

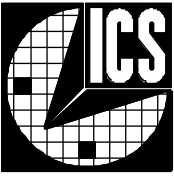

Absolute Maximum Ratings

AVDD, VDD referenced to GND 7V
 Operating temperature under bias 0°C to +70°C
 Storage temperature -65°C to +150°C
 Voltage on I/O pins referenced to GND GND -0.5V to VDD +0.5V
 Power dissipation 0.5 Watts

Stresses above those listed under Absolute Maximum Ratings may cause permanent damage to the device. This is a stress rating only and functional operation of the device at these or any other conditions above those indicated in the operational sections of the specifications is not implied. Exposure to absolute maximum rating conditions for extended periods may affect product reliability.

Electrical Characteristics at 5 V

V_{DD} = +4.5 to +5.5 V, T_A = 0 to 70°C unless otherwise stated

DC Characteristics						
PARAMETER	SYMBOL	TEST CONDITIONS	MIN	TYP	MAX	UNITS
Input Low Voltage	V _{IL}		-	-	0.8	V
Input High Voltage	V _{IH}		2.0	-	-	V
Input Low Current	I _{IL}	V _{IN} =0V	-18.0	-8.3	-	μA
Input High Current	I _{IH}	V _{IN} =V _{DD}	-	-	5.0	μA
Output Low Voltage	V _{OL} *	I _{OL} =+10mA	-	0.15	0.4	V
Output High Voltage	V _{OH} *	I _{OH} =-30mA	2.4	3.7	-	V
Output Low Current	I _{OL} *	V _{OL} =0.8V	25.0	45.0	-	mA
Output High Current	I _{OH} *	V _{OH} =2.4V	-	-53.0	-35.0	mA
Supply Current	I _{DD} *	Unloaded	-	30.0	70.0	mA
Pull-up Resistor Value	R _{pu} *		-	400.0	800.0	k ohm
AC Characteristics						
Rise Time	T _r *	15pF load 0.8 to 2.0V	-	0.8	2.0	ns
Fall Time	T _f *	15pF load 2.0 to 0.8V	-	0.6	1.5	ns
Rise Time	T _r *	15pF load 20% to 80%	-	1.7	2.5	ns
Fall Time	T _f *	15pF load 80% to 20%	-	1.1	2.0	ns
Duty Cycle	D _t *	15pF load @ 50% of V _{DD} ; Except REFCLK	45.0	50.0	55.0	%
Duty Cycle	D _t *	15pF load @ 50% of V _{DD} ; REFCLK only	40.0	55.0	60.0	%
Jitter, One Sigma	T _{jis} *	For all frequencies except REFCLK	-	100.0	140.0	ps
Jitter, Absolute	T _{jab} *	For all frequencies except REFCLK	-400.0	250.0	400.0	ps
Jitter, One Sigma	T _{jis} *	REFCLK only	-	150.0	150.0	ps
Jitter Absolute	T _{jab} *	REFCLK only	-700.0	400.0	700.0	ns
Input Frequency Range	F _i *		11.0	14.0	17.0	MHz
Output Frequency Range	F _o *		14.0	-	52.0	MHz
Power-up Time	T _{pu} *	0 to 40.3 MHz	-	5.5	12.0	ms
Crystal Input Capacitance	C _{inx} *	X1 (Pin 1), X2 (Pin 8)	-	5	-	pF

*Parameter is guaranteed by design and characterization. Not 100% tested in production.

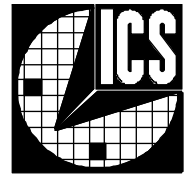

Electrical Characteristics at 3.3 V

$V_{DD} = +3.0$ to $+3.7V$, $T_A = 0^{\circ}C$ - $70^{\circ}C$ unless otherwise stated

DC Characteristics						
PARAMETER	SYMBOL	TEST CONDITIONS	MIN	TYP	MAX	UNITS
Input Low Voltage	V_{IL}		-	-	$0.2V_{DD}$	V
Input High Voltage	V_{IH}		$0.7V_{DD}$	-	-	V
Input Low Current	I_{IL}	$V_{IN}=0V$	-8.0	-3.6	-	μA
Input High Current	I_{IH}	$V_{IN}=V_{DD}$	-	-	5.0	μA
Output Low Voltage	V_{OL}^*	$I_{OL}=6.0mA$	-	$0.05V_{DD}$	0.1	V
Output High Voltage	V_{OH}^*	$I_{OH}=4.0mA$	$0.85V_{DD}$	$0.94V_{DD}$	-	V
Output Low Current	I_{OL}^*	$V_{OL}=0.2V_{DD}$	15.0	24.0	-	mA
Output High Current	I_{OH}^*	$V_{OH}=0.7V_{DD}$	-	-13.0	-8.0	mA
Supply Current	I_{DD}^*	Unloaded	-	20.0	45.0	mA
AC Characteristics						
Rise Time	T_r^*	15pF load 0.8 to 2.0V	-	2.2	3.5	ns
Fall Time	T_f^*	15pF load 2.0 to 0.8V	-	1.2	2.0	ns
Rise Time	T_r^*	15pF load 20% to 80%	-	2.5	3.5	ns
Fall Time	T_f^*	15pF load 80% to 20%	-	1.4	2.5	ns
Duty Cycle	D_r^*	15pF load @ 50% of V_{DD} ; Except REFCLK	45.0	50.0	55.0	%
Duty Cycle	D_f^*	15pF load @ 50% of V_{DD} ; REFCLK only	45.0	57.0	65.0	%
Jitter, One Sigma	T_{jis}^*	For all frequencies except REFCLK	-	150.0	200	ps
Jitter Absolute	T_{jab}^*	For all frequencies except REFCLK	-500.0	300.0	500.0	ps
Jitter, One Sigma	T_{jis}^*	REFCLK only	-	170.0	250.0	ps
Jitter, Absolute	T_{jab}^*	REFCLK only	-500.0	350.0	500.0	ns
Input Frequency Range	F_i^*		11.0	14.3	15.0	MHz
Output Frequency Range	F_o^*		14.0	-	52.0	MHz
Power-up Time	T_{pu}^*	0 to 40.3 MHz	-	5.5	12.0	ms
Crystal Input Capacitance	C_{inx}^*	X1 (Pin 1), X2 (Pin 8)	-	5	-	pF

*Parameter is guaranteed by design and characterization. Not 100% tested in production.

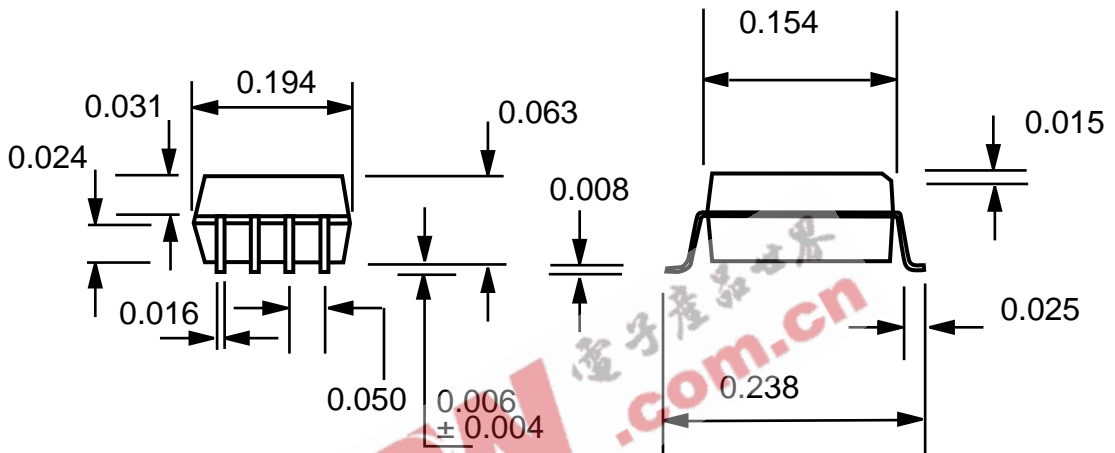
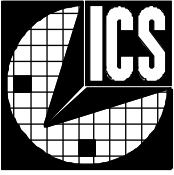

8-Pin SOIC Package

Ordering Information

ICS9120M-47

Example:

ICS XXXX M-PPP

