

**FEATURES**

- 12/10/8-Bit Monotonic Dual DAC in 16 Lead QSOP Package
- Adjustable Output Gain
- Rail-to-Rail Voltage Output
- 150  $\mu$ A per DAC at 5V Supply
- 100  $\mu$ A per DAC at 3V Supply
- On Board Reference
- Serial Interface with three-wire SPI/QSPI and Microwire Interface Compatible
- Serial Data Out for Daisy-Chaining
- 8  $\mu$ S Full scale Settling Time

**APPLICATION**

- Battery-Powered Applications
- Industrial Process Control
- Digital Gain and Offset Adjustment

**OVERVIEW**

The ICM7373, ICM7353 and ICM7333 are Dual 12-Bit, 10-Bit and 8-Bit Rail-to-Rail voltage output DACs respectively, with guaranteed monotonic behavior. These DACs are available in 16 Lead QSOP package. They include adjustable output gain for ease of use and flexibility. The reference output is available on a separate pin and can be used to drive external loads. The operating supply range is 2.7V to 5.5V.

The input interface is an easy to use three-wire SPI/QSPI and Microwire compatible interface. The DAC has a double buffered digital input. And there is a serial data output port to allow daisy-chaining applications.

**BLOCK DIAGRAM**

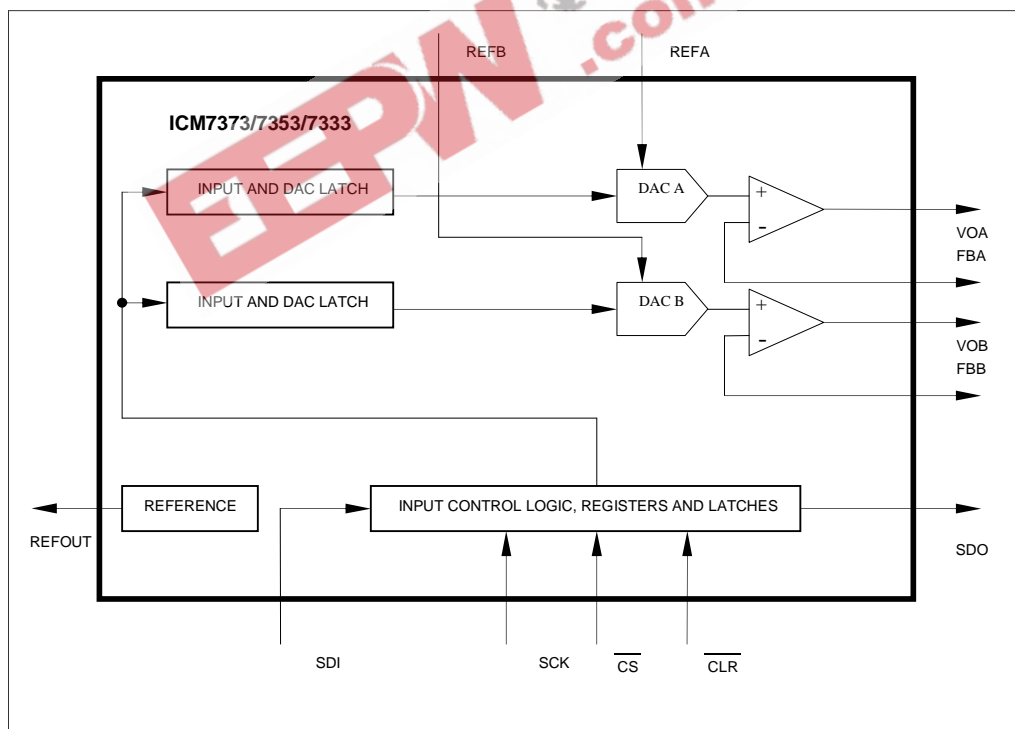

**PACKAGE**

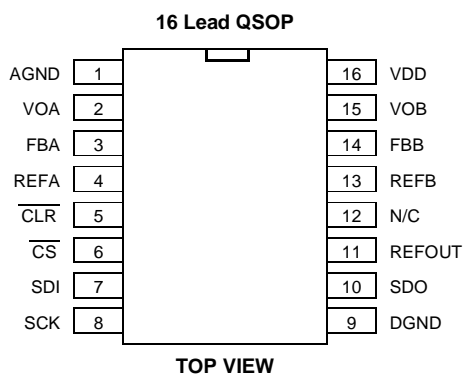

**PIN DESCRIPTION (16 Lead QSOP)**

| Pin | Name   | I/O | Description  |
|-----|--------|-----|--|
| 1   | AGND   | I   | Analog Ground  |
| 2   | VOA    | O   | DAC A Output Voltage   |
| 3   | FBA    | I   | Inverting Input of The Output Amplifier DAC A. Output Amplifier Feedback Input.    |
| 4   | REFA   | I   | Reference Voltage Input for DAC A  |
| 5   | CLR    | I   | Active Low Clear Input (CMOS). Resets All Registers to Zero. DAC outputs go to 0 V |
| 6   | CS     | I   | Active Low Chip Select (CMOS)  |
| 7   | SDI    | I   | Serial Data Input (CMOS)   |
| 8   | SCK    | I   | Serial Clock Input (CMOS)  |
| 9   | DGND   | I   | Digital Ground   |
| 10  | SDO    | O   | Serial Data Output   |
| 11  | REFOUT | O   | Reference Output   |
| 12  | N/C    | -   | No Connection  |
| 13  | REFB   | I   | Reference Voltage Input for DAC B  |
| 14  | FBB    | I   | Inverting Input of The Output Amplifier DAC B. Output Amplifier Feedback Input.    |
| 15  | VOB    | O   | DAC B Output Voltage   |
| 16  | VDD    | I   | Supply Voltage   |

**ABSOLUTE MAXIMUM RATING**

| Symbol              | Parameter   | Value       | Unit |
|---------------------|---|-------------|------|
| V <sub>DD</sub>     | Supply Voltage  | -0.3 to 7.0 | V    |
| I <sub>IN</sub>     | Input Current   | +/- 25.0    | mA   |
| V <sub>IN_</sub>    | Digital Input Voltage (SCK, SDI, $\overline{\text{CS}}$ , $\overline{\text{CLR}}$ ) | -0.3 to 7.0 | V    |
| V <sub>IN_REF</sub> | Reference Input Voltage   | -0.3 to 7.0 | V    |
| T <sub>STG</sub>    | Storage Temperature   | -65 to +150 | °C   |
| T <sub>SOL</sub>    | Soldering Temperature   | 300         | °C   |

**Note:** Stress greater than those listed under ABSOLUTE MAXIMUM RATINGS may cause permanent damage to the device. This is a stress rating only and functional operation of the device at these or any other conditions above those indicated in the operational sections of this specification is not implied. Exposure to absolute maximum rating conditions for extended periods may affect reliability.

**ORDERING INFORMATION**

| Part    | Operating Temperature Range | Package     |
|---------|-----------------------------|-------------|
| ICM7373 | -40 °C to 85 °C             | 16-Pin QSOP |
| ICM7353 | -40 °C to 85 °C             | 16-Pin QSOP |
| ICM7333 | -40 °C to 85 °C             | 16-Pin QSOP |

**DC ELECTRICAL CHARACTERISTICS**

(V<sub>DD</sub> = 2.7V to 5.5V; V<sub>OUT</sub> unloaded; all specifications T<sub>MIN</sub> to T<sub>MAX</sub> unless otherwise noted)

| Symbol                    | Parameter                 | Test Conditions | Min | Typ  | Max   | Unit    |
|---------------------------|---------------------------|-----------------|-----|------|-------|---------|
| <b>DC PERFORMANCE</b>     |                           |                 |     |      |       |         |
| ICM7373                   |                           |                 |     |      |       |         |
| N                         | Resolution                |                 | 12  |      |       | Bits    |
| DNL                       | Differential Nonlinearity | (Notes 1 & 3)   |     | 0.4  | ±1.0  | LSB     |
| INL                       | Integral Nonlinearity     | (Notes 1 & 3)   |     | 4.0  | ±12.0 | LSB     |
| ICM7353                   |                           |                 |     |      |       |         |
| N                         | Resolution                |                 | 10  |      |       | Bits    |
| DNL                       | Differential Nonlinearity | (Notes 1 & 3)   |     | 0.1  | ±1.0  | LSB     |
| INL                       | Integral Nonlinearity     | (Notes 1 & 3)   |     | 1.0  | ±3.0  | LSB     |
| ICM7333                   |                           |                 |     |      |       |         |
| N                         | Resolution                |                 | 8   |      |       | Bits    |
| DNL                       | Differential Nonlinearity | (Notes 1 & 3)   |     | 0.05 | ±1.0  | LSB     |
| INL                       | Integral Nonlinearity     | (Notes 1 & 3)   |     | 0.25 | ±0.75 | LSB     |
| GE                        | Gain Error                |                 |     |      | ±0.5  | % of FS |
| OE                        | Offset Error              |                 |     |      | ±25   | mV      |
| <b>POWER REQUIREMENTS</b> |                           |                 |     |      |       |         |
| V <sub>DD</sub>           | Supply Voltage            |                 | 2.7 |      | 3.6   | V       |
| I <sub>DD</sub>           | Supply Current            |                 |     | 0.6  | 1.5   | mA      |

| Symbol                        | Parameter                        | Test Conditions                              | Min | Typ        | Max        | Unit                 |
|-------------------------------|----------------------------------|--|-----|------------|------------|----------------------|
| <b>OUTPUT CHARACTERISTICS</b> |                                  |  |     |            |            |                      |
|                               | Output Voltage Range             | (Note 3)                                     | 0   |            | $V_{DD}$   | V                    |
| $V_{OSC}$                     | Short Circuit Current            |  |     | 60         | 150        | mA                   |
| $R_{OUT}$                     | Amp Output Impedance             | At Mid-scale (Note 2)<br>At 0-scale (Note 2) |     | 1.0<br>100 | 5.0<br>200 | $\Omega$<br>$\Omega$ |
|                               | Output Line Regulation           | $V_{DD}=2.7$ to $3.6$ V                      |     | 0.4        | 3.0        | mV/V                 |
| <b>LOGIC INPUTS</b>           |                                  |  |     |            |            |                      |
| $V_{IH}$                      | Digital Input High               | (Note 2)                                     | 2.4 |            |            | V                    |
| $V_{IL}$                      | Digital Input Low                | (Note 2)                                     |     |            | 0.8        | V                    |
|                               | Digital Input Leakage            |  |     |            | 5          | $\mu$ A              |
| <b>REFERENCE</b>              |                                  |  |     |            |            |                      |
| $V_{REFOUT}$                  | Reference Output                 |  | 1.2 | 1.25       | 1.3        | V                    |
|                               | Reference Output Line Regulation |  |     | 0.8        | 4.0        | mV/V                 |

#### AC ELECTRICAL CHARACTERISTICS

( $V_{DD} = 2.7V$  to  $5.5V$ ;  $V_{OUT}$  unloaded; all specifications  $T_{MIN}$  to  $T_{MAX}$  unless otherwise noted)

| Symbol | Parameter                          | Test Conditions | Min | Typ | Max | Unit       |
|--------|------------------------------------|-----------------|-----|-----|-----|------------|
| SR     | Slew Rate                          |                 |     | 2   |     | V/ $\mu$ s |
|        | Settling Time                      |                 |     | 8   |     | $\mu$ s    |
|        | Mid-scale Transition Glitch Energy |                 |     | 40  |     | nV-S       |

- Note 1: Linearity is defined from code 64 to 4095 (ICM7373)  
Linearity is defined from code 16 to 1023 (ICM7353)  
Linearity is defined from code 4 to 255 (ICM7333)  
Note 2: Guaranteed by design; not tested in production  
Note 3: See Applications Information

#### TIMING CHARACTERISTICS

( $V_{DD} = 2.7V$  to  $5.5V$ ; all specifications  $T_{MIN}$  to  $T_{MAX}$  unless otherwise noted)

| Symbol | Parameter                                       | Test Conditions | Min | Typ | Max | Unit |
|--------|---|-----------------|-----|-----|-----|------|
| $t_1$  | SCK Cycle Time                                  | (Note 2)        | 30  |     |     | ns   |
| $t_2$  | Data Setup Time                                 | (Note 2)        | 10  |     |     | ns   |
| $t_3$  | Data Hold Time                                  | (Note 2)        | 10  |     |     | ns   |
| $t_4$  | SCK Falling edge to $\overline{CS}$ Rising Edge | (Note 2)        | 0   |     |     | ns   |
| $t_5$  | $\overline{CS}$ Falling Edge to SCK Rising Edge | (Note 2)        | 15  |     |     | ns   |
| $t_6$  | $\overline{CS}$ Pulse Width                     | (Note 2)        | 20  |     |     | ns   |

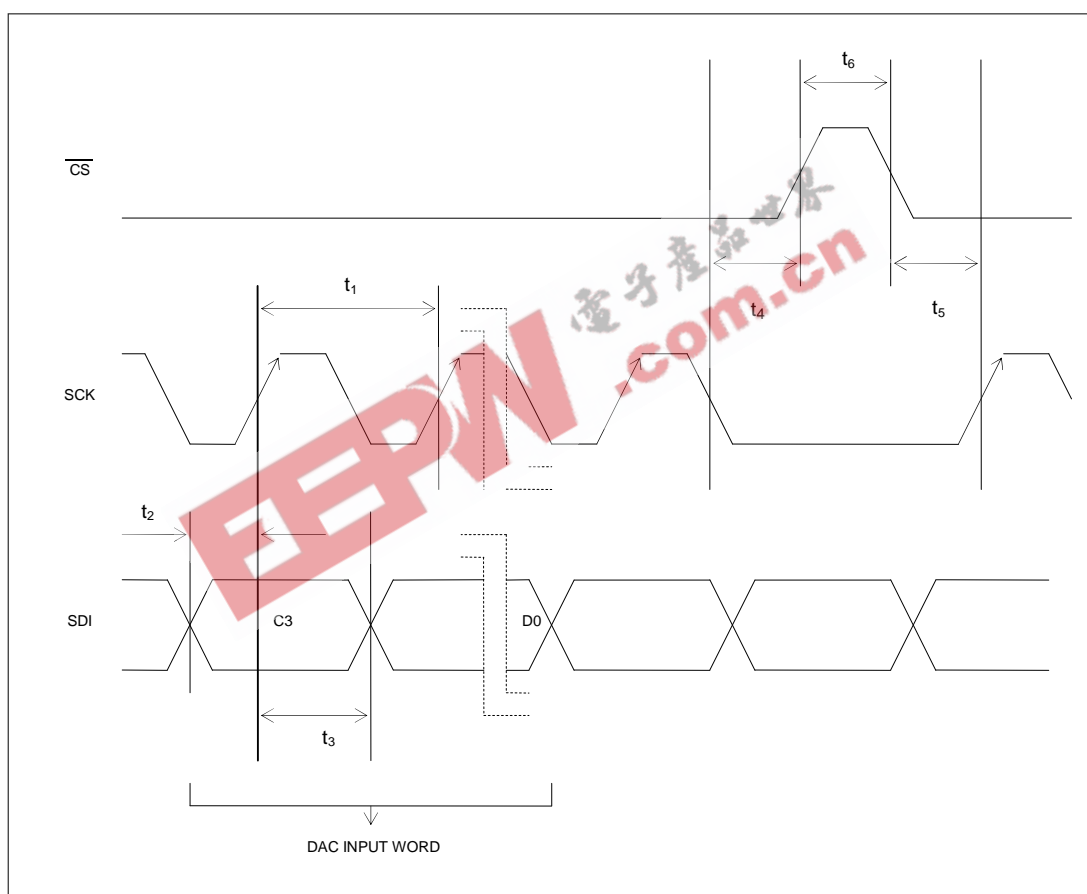

**Figure 1.** Serial Interface Timing Diagram

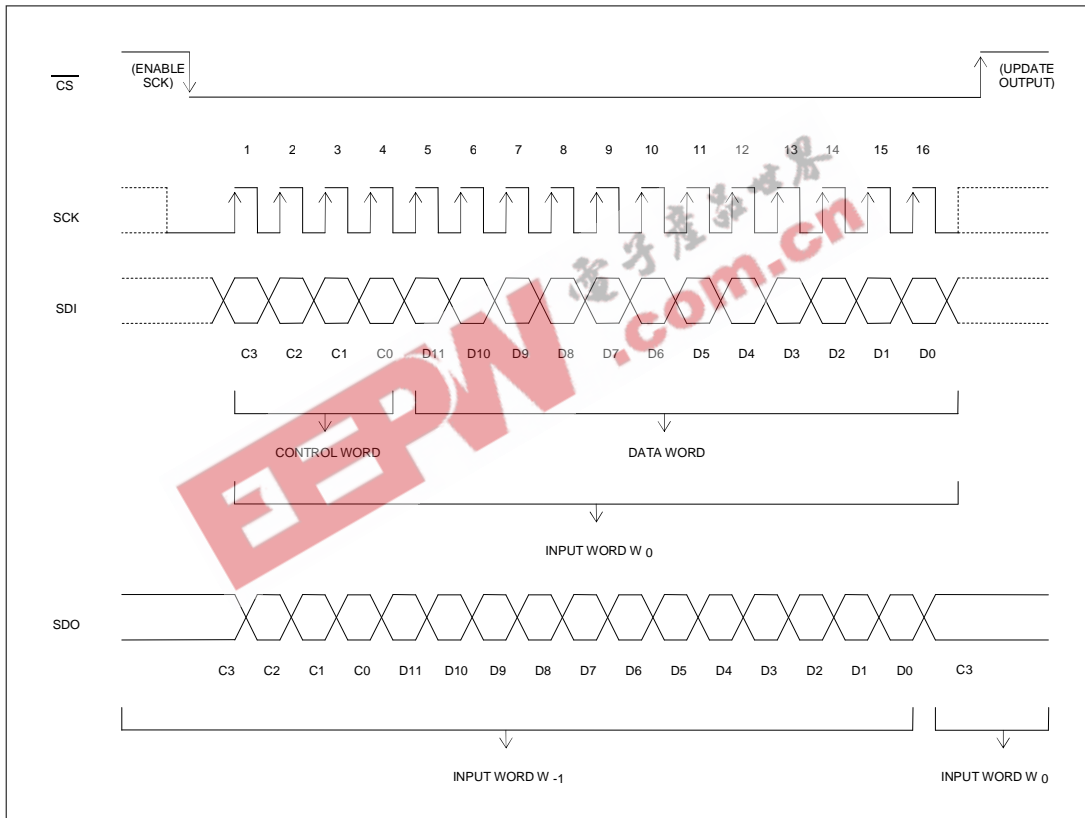

Figure 2. Serial Interface Operation Diagram

**CONTENTS OF INPUT SHIFT REGISTER**

**ICM7373 (12-Bit DAC)**

|              |    |    |    |           |     |    |    |    |    |    |    |    |    |    |    |            |  |  |  |
|--------------|----|----|----|-----------|-----|----|----|----|----|----|----|----|----|----|----|------------|--|--|--|
| <b>MSB</b>   |    |    |    |           |     |    |    |    |    |    |    |    |    |    |    | <b>LSB</b> |  |  |  |
| C3           | C2 | C1 | C0 | D11       | D10 | D9 | D8 | D7 | D6 | D5 | D4 | D3 | D2 | D1 | D0 |            |  |  |  |
| CONTROL WORD |    |    |    | DATA WORD |     |    |    |    |    |    |    |    |    |    |    |            |  |  |  |

**Figure 3.** Contents of ICM7373 Input Shift Register

**ICM7353 (10-Bit DAC)**

|              |    |    |    |           |    |    |    |    |    |    |    |    |    |            |   |
|--------------|----|----|----|-----------|----|----|----|----|----|----|----|----|----|------------|---|
| <b>MSB</b>   |    |    |    |           |    |    |    |    |    |    |    |    |    | <b>LSB</b> |   |
| C3           | C2 | C1 | C0 | D9        | D8 | D7 | D6 | D5 | D4 | D3 | D2 | D1 | D0 | X          | X |
| CONTROL WORD |    |    |    | DATA WORD |    |    |    |    |    |    |    |    |    | X          | X |

**Figure 4.** Contents of ICM7353 Input Shift Register

**ICM7333 (8-Bit DAC)**

|              |    |    |    |           |    |    |    |    |    |    |    |            |   |   |   |
|--------------|----|----|----|-----------|----|----|----|----|----|----|----|------------|---|---|---|
| <b>MSB</b>   |    |    |    |           |    |    |    |    |    |    |    | <b>LSB</b> |   |   |   |
| C3           | C2 | C1 | C0 | D7        | D6 | D5 | D4 | D3 | D2 | D1 | D0 | X          | X | X | X |
| CONTROL WORD |    |    |    | DATA WORD |    |    |    |    |    |    |    | X          | X | X | X |

**Figure 5.** Contents of ICM7333 Input Shift Register

| C3 | C2 | C1 | C0 | DATA (D0 - D11) | FUNCTION                             |
|----|----|----|----|-----------------|--------------------------------------|
| 0  | 0  | 0  | 0  | Data            | Load Input Latch DAC A               |
| 0  | 0  | 0  | 1  | Data            | Update DAC A                         |
| 0  | 0  | 1  | 0  | Data            | Load Input Latch and Update DAC A    |
| 0  | 0  | 1  | 1  | Data            | Load Input Latch DAC B               |
| 0  | 1  | 0  | 0  | Data            | Update DAC B                         |
| 0  | 1  | 0  | 1  | Data            | Load Input Latch and Update DAC B    |
| 0  | 1  | 1  | 0  | X               | No Operation                         |
| 0  | 1  | 1  | 1  | X               | No Operation                         |
| 1  | 0  | 0  | 0  | X               | No Operation                         |
| 1  | 0  | 0  | 1  | X               | No Operation                         |
| 1  | 0  | 1  | 0  | X               | No Operation                         |
| 1  | 0  | 1  | 1  | X               | No Operation                         |
| 1  | 1  | 0  | 0  | Data            | Load Input Latch All DACs            |
| 1  | 1  | 0  | 1  | Data            | Update All DACs                      |
| 1  | 1  | 1  | 0  | Data            | Load Input Latch and Update All DACs |
| 1  | 1  | 1  | 1  | X               | No Operation                         |

**Table 1.** Serial Interface Input Word

## DETAILED DESCRIPTION

The ICM7373 is a 12-bit voltage output dual DAC. The ICM7353 is the 10-bit version of this family and the ICM7333 is the 8-bit version.

This family of DACs employs a resistor string architecture guaranteeing monotonic behavior. There is a 1.25V onboard reference and an operating supply range of 2.7V to 5.5V.

### Reference Input

Determine the output voltage using the following equation:

$$V_{OUT} = V_{REF} \times (D / (2^n))$$

Where D is the numeric value of DAC's decimal input code,  $V_{REF}$  is the reference voltage and n is number of bits, i.e. 12 for ICM7373, 10 for ICM7353 and 8 for ICM7333.

### Reference Output

The reference output is nominally 1.25V and is brought out to a separate pin and can be used to drive external loads. The outputs will nominally swing from 0 to 2.5V.

### Output Amplifier

The dual DAC has 2 output amplifiers with a rail-to-rail output swing. The actual swing of the output amplifiers will be limited by offset error and gain error. See the Applications Information Section for a more detailed discussion.

The 2 output amplifier's inverting input of 2 DACs are available to the user, allowing force and sense capability for remote sensing and specific gain adjustment. The unity gain can be provided by connecting the inverting input to the output.

The output amplifier can drive a load of 2.0 k $\Omega$  to  $V_{DD}$  or GND in parallel with a 500 pF load capacitance.

The output amplifier has a full-scale typical settling time of 8  $\mu$ s and it dissipates about 100  $\mu$ A with a 3V supply voltage.

### Serial Interface and Input Logic

This dual DAC family uses a standard 3-wire connection compatible with SPI/QSPI and Microwire interfaces. Data is loaded in 16-bit words which consist of 4 address and control bits (MSBs) followed by 12 bits of data (see table 1). The ICM7353 has the last 2 LSBs as don't care and the ICM7333 has the last 4 LSBs as don't care. The DAC is double buffered with an input latch and a DAC latch.

### Serial Data Input

SDI (Serial Data Input) pin is the data input pin for All DACs. Data is clocked in on the rising edge of SCK which has a Schmitt trigger internally to allow for noise immunity on the SCK pin. This specially eases the use for opto-coupled interfaces.

The Chip Select pin which is the 6<sup>th</sup> pin of 16 QSOP package is active low. This pin must be low when data is being clocked into the part. After the 16<sup>th</sup> clock pulse the Chip Select pin must be pulled high (level-triggered) for the data to be transferred to an input bank of latches. This pin also disables the SCK pin internally when pulled high and the SCK pin must be low before this pin is pulled back low. As the Chip Select pin is pulled high the shift register

contents are transferred to a bank of 16 latches (see Figure 2.). The 4 bit control word (C3-C0) is then decoded and the DAC is updated or loaded depending on the control word (see Table 1).

The DAC has a double-buffered input with an input latch and a DAC latch. The DAC output will swing to its new value when data is loaded into the DAC latch. The user has three options: loading only the input latch, updating the DAC with data previously loaded into the input latch or loading the input latch and updating the DAC at the same time with a new code.

### Serial Data Output

SDO (Serial Data Output) is the internal shift register's output. This pin can be used as the data output pin for Daisy-Chaining and data readback. And it is compatible with SPI/QSPI and Microwire interfaces.

### Power-On Reset

There is a power-on reset on board that will clear the contents of all the latches to all 0s on power-up and the DAC voltage output will go to ground.

## APPLICATIONS INFORMATION

### Power Supply Bypassing and Layout Considerations

As in any precision circuit, careful consideration has to be given to layout of the supply and ground. The return path from the GND to the supply ground should be short with low impedance. Using a ground plane would be ideal. The supply should have some bypassing on it. A 10  $\mu$ F tantalum capacitor in parallel with a 0.1  $\mu$ F ceramic with a low ESR can be used. Ideally these would be placed as close as possible to the device. Avoid crossing digital and analog signals, specially the reference, or running them close to each other.

### Output Swing Limitations

The ideal rail-to-rail DAC would swing from GND to  $V_{DD}$ . However, offset and gain error limit this ability. Figure 6 illustrates how a negative offset error will affect the output. The output will limit close to ground since this is single supply part, resulting in a dead-band area. As a larger input is loaded into the DAC the output will eventually rise above ground. This is why the linearity is specified for a starting code greater than zero.

Figure 7 illustrates how a gain error or positive offset error will affect the output when it is close to  $V_{DD}$ . A positive gain error or positive offset will cause the output to be limited to the positive supply voltage resulting in a dead-band of codes close to full-scale.



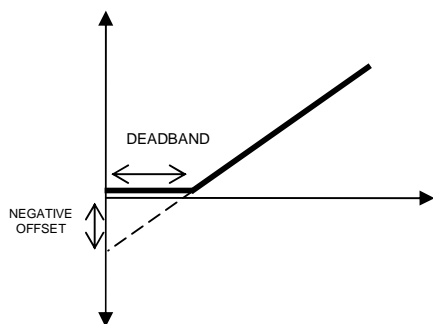

Figure 6. Effect of Negative Offset

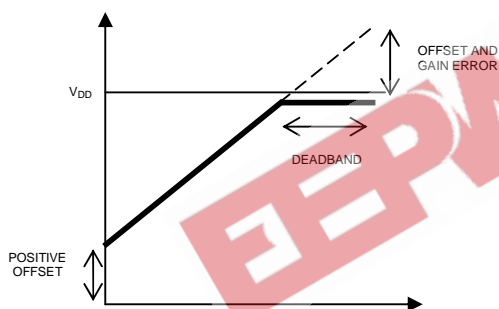
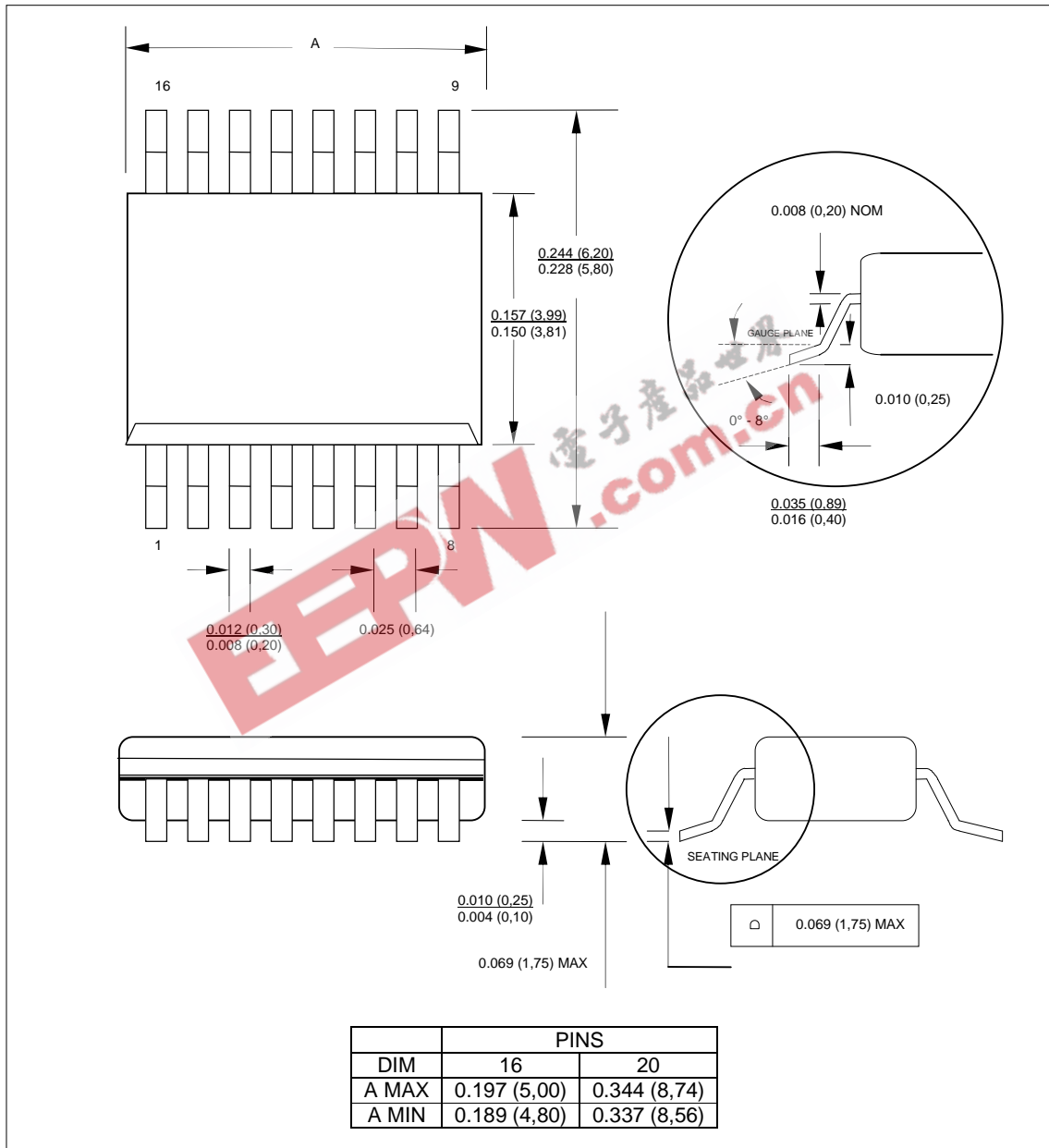

Figure 7. Effect of Gain Error and Positive Offset

**PACKAGE INFORMATION**

**16 GSOP**



**Note:**

1. All Linear dimensions are in inches (millimeters) format
2. This drawing is subject to change without notice
3. Body dimensions do not include mold flash or protrusion not to exceed 0.006 (0,15).
4. Falls within JEDEC MO-137.

**ORDERING INFORMATION**

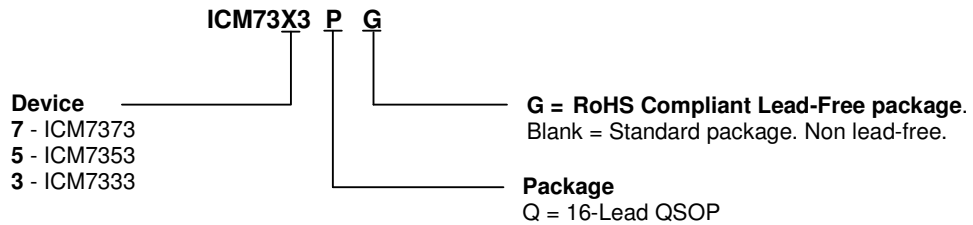

EEPW 电子产品世界  
.com.cn