

## Frequency Generator for Modem Systems

### General Description

The ICS9117-01 is a low-cost, high-performance frequency generator designed to support fax/data modem systems. Datapump and UART clocks are synthesized from a microcontroller crystal using high-accuracy, low-jitter PLLs, meeting the frequency tolerance and -96dB signal-to-noise ratios required by 16-bit DSP modem systems. Fast output clock edge rates minimize board induced jitter.

Exact frequency multiplying ratios ensure better than  $\pm 80$  ppm frequency accuracy using a standard AT crystal with external load capacitors (typically 33pF  $\pm 5\%$  for an 18pF series load crystal). Achieving  $\pm 80$ ppm over four years requires the crystal to have 20 ppm initial accuracy,  $\pm 20$  ppm temperature and  $\pm 5$  ppm/year aging coefficients.

### Features

- Generates the 14.7456 MHz microcontroller, 40.320 MHz datadump and 1.84320 UART clocks
- Less than  $\pm 80$  ppm frequency variation including temperature, voltage, load and aging tolerances
- Single crystal reference minimizes crystal reliability and inventory issues
- 80 ps one sigma jitter maintains 16-bit performance
- Output rise/fall times less than 1.5 ns
- On-chip loop filter components
- 3.0 V - 5.5 V supply range
- 8-pin, 150-mil SOIC package

### Applications

- Specifically designed to support the high performance of fax/data modems

### Block Diagram

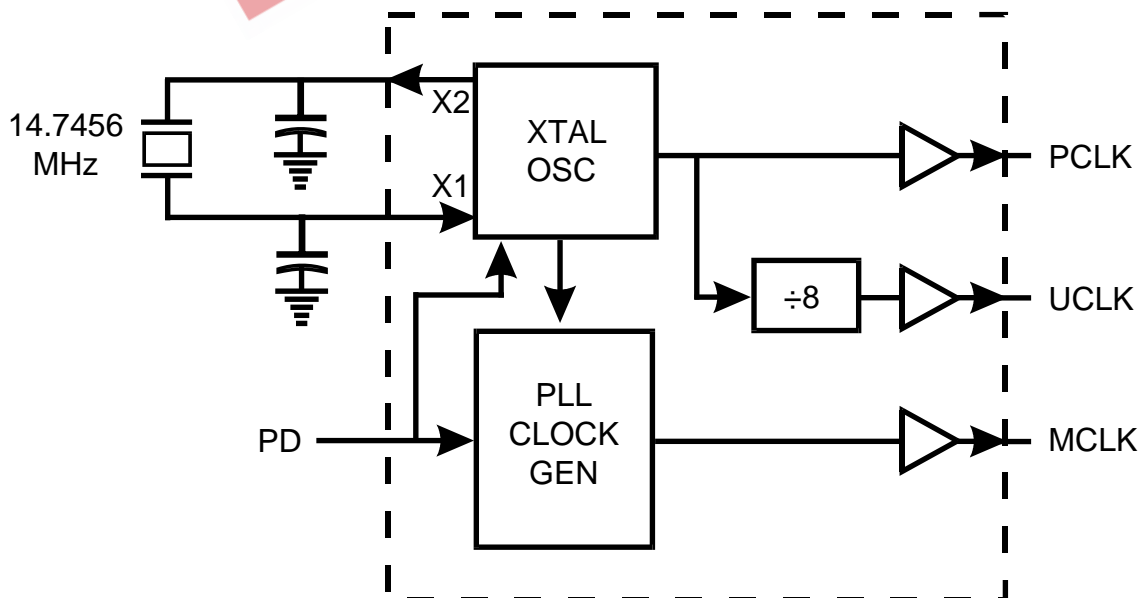

# ICS9117-01

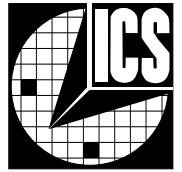

## Pin Configuration

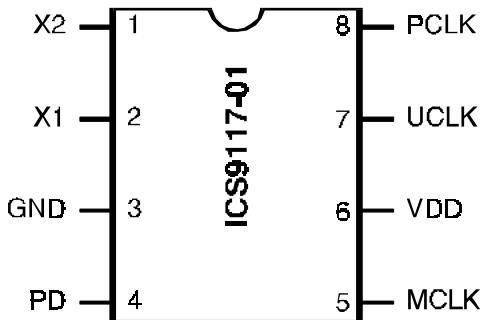

8-PIN SOIC

## Functionality

X1, X2 (MHz)	PD	PCLK (MHz)	MCLK (MHz)	UCLK (MHz)
14.7456	0	14.7456	40.320	1.8432
14.7456	1	Low	Low	Low

## Pin Descriptions

PIN NUMBER	PIN NAME	TYPE	DESCRIPTION
1	X2	OUT	Drive to crystal.
2	X1	IN	Crystal or clock input.
3	GND	PWR	Power supply ground.
4	PD	IN	Power-down signal. Power-down all loops and oscillators.
5	MCLK	OUT	Datapump 40.32 MHz clock output.
6	VDD	PWR	+5V powersupply
7	UCLK	OUT	UART 1.84 MHz data clock output.
8	PCLK	OUT	Microcontroller 14.7 MHz clock output.

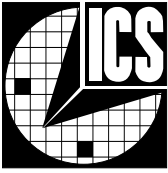

### Absolute Maximum Ratings

AV<sub>DD</sub>, V<sub>DD</sub> referenced to GND ----- 7V  
 Operating temperature under bias ----- 0 °C to +70 °C  
 Storage temperature ----- -65 °C to +150 °C  
 Voltage on I/O pins referenced to GND ----- GND - 0.5V to V<sub>DD</sub> + 0.5V  
 Power dissipation ----- 0.5 Watts

Stresses above those listed under Absolute Maximum Ratings may cause permanent damage to the device. This is a stress rating only and functional operation of the device at these or any other conditions above those indicated in the operational sections of the specifications is not implied. Exposure to absolute maximum rating conditions for extended periods may affect product reliability.

### Electrical Characteristics at 3.3V

Operating V<sub>DD</sub> = +3.0V to +3.7V; T<sub>A</sub> = 0 °C to 70 °C unless otherwise stated

DC Characteristics						
PARAMETER	SYMBOL	TEST CONDITIONS	MIN	TYP	MAX	UNITS
Input Low Voltage	V <sub>IL</sub>		-	-	0.8	V
Input High Voltage	V <sub>IH</sub>		2.0	-	-	V
Input Low Current	I <sub>IL</sub>	V <sub>IN</sub> =0V	-	-10.0	-25.0	µA
Input High Current	I <sub>IH</sub>	V <sub>IN</sub> =V <sub>DD</sub>	-	-	5.0	µA
Output Low Voltage	V <sub>OL</sub> *	I <sub>OL</sub> =+10mA	-	0.15	0.4	V
Output High Voltage	V <sub>OH</sub> *	I <sub>OH</sub> =-10mA	2.4	3.7	-	V
Output Low Current	I <sub>OL</sub> *	V=0.8V	20.0	35.0	-	mA
Output High Current	I <sub>OH</sub> *	V=2.4V	-	-20.0	-10.0	mA
Supply Current	I <sub>CC</sub>	Unloaded	-	16.0	30.0	mA
Pull-up Resistor Value	R <sub>pu</sub> *		-	400.0	800.0	k ohm
AC Characteristics						
Rise Time	T <sub>r</sub> *	15o/f kiadm 0.8 to 2.0V	-	0.9	1.5	ns
Fall Time	T <sub>f</sub> *	15pF load, 2.0 to 0.8V	-	1.2	3.0	ns
Lock Time	T <sub>L</sub> *	15pFload, 20%to 80%			10.0	ms
Duty Cycle	D <sub>t</sub> *	15pFload @50% of VDD; ExceptREFCLK	45.0	50.0	55.0	%
Duty Cycle	D <sub>t</sub> *	15pF load@50% of VDD; Except REFCLK only	45.0	50.0	55.0	%
Jitter, One Sigma	T <sub>j1s</sub> *	For all frequencies except REFCLK		70.0	100.0	ps
Jitter, Absolute	T <sub>jab</sub> *	For all frequencies except REFCLK	-300.0		+300.0	ps
Jitter, One Sigma	T <sub>j1s</sub> *	REFCLK only		250.0	300.0	ps
Jitter, Absolute	T <sub>jab</sub> *	REFCLK only	-500.0		+500.0	ps
Input Frequency Range	F <sub>i</sub> *		4.0		28.0	MHz
Output Frequency Range	F <sub>o</sub> *		11.7		74.0	MHz
Output Mean Frequency Accuracy vs.Target	F <sub>oa</sub> *	With 14.318 MHz input	-80.0		+80.0	ppm
Power-up Time	T <sub>pu</sub> *	0 to 33.8 MHz		2.5	4.5	ms
Crystal Input Capacitance	C <sub>inx</sub> *	X1 (Pin 1) X2 (Pin 8)		18.0		pF

\* Parameter is guaranteed by design and characterization. Not 100% tested in production.

# ICS9117-01

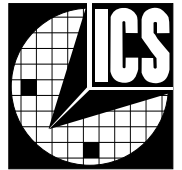

## Absolute Maximum Ratings

$V_{DD}$ ,  $V_{DD}$  referenced to GND ----- 7V  
 Operating temperature under bias ----- 0 °C to +70 °C  
 Storage temperature ----- -65 °C to +150 °C  
 Voltage on I/O pins referenced to GND ----- GND - 0.5V to  $V_{DD}$  + 0.5V  
 Power dissipation ----- 0.5 Watts

Stresses above those listed under Absolute Maximum Ratings may cause permanent damage to the device. This is a stress rating only and functional operation of the device at these or any other conditions above those indicated in the operational sections of the specifications is not implied. Exposure to absolute maximum rating conditions for extended periods may affect product reliability.

## Electrical Characteristics at 5.0V

Operating  $V_{DD}$  = +4.5 V to +5.5V;  $T_A$  = 0 °C to 70°C unless otherwise stated

DC Characteristics						
PARAMETER	SYMBOL	TEST CONDITIONS	MIN	TYP	MAX	UNITS
Input Low Voltage	$V_{IL}$		-	-	0.8	V
Input High Voltage	$V_{IH}$		2.0	-	-	V
Input Low Current	$I_{IL}$	$V_{IN}=0V$	-	-7.0	-25.0	$\mu A$
Input High Current	$I_{IH}$	$V_{IN}=V_{DD}$	-	-	5.0	$\mu A$
Output Low Voltage	$V_{OL}^*$	$I_{OL}=+10mA$	-	0.15	0.4	V
Output High Voltage	$V_{OH}^*$	$I_{OH}=-10mA$	4.0	4.2	-	V
Output Low Current	$I_{OL}^*$	$V=0.8V$	20.0	40.0	-	mA
Output High Current	$I_{OH}^*$	$V=2.4V$	-	-85.0	-65.0	mA
Supply Current	$I_{CC}$	Unloaded	-	22.0	-35.0	mA
Pull-up Resistor Value	$R_{pu}^*$		-	400.0	800.0	k ohm
AC Characteristics						
Rise Time	$T_r^*$	150/f kiadm 0.8 to 2.0V	-	0/8	1.5	ns
Fall Time	$T_f^*$	15pF load, 2.0 to 0.8V	-	1.2	3.0	ns
Lock Time	$T_L^*$	15pFload, 20%to 80%			10.0	ms
Duty Cycle	$D_t^*$	15pFload @50% of $V_{DD}$ ; Except REFCLK	45.0	50.0	55.0	%
Duty Cycle	$D_t^*$	15pF load@50% of $V_{DD}$ ; REFCLK only	45.0	50.0	55.0	%
Jitter, One Sigma	$T_{j1s}^*$	For all frequencies except REFCLK		80.0	120.0	ps
Jitter, Absolute	$T_{jab}^*$	For all frequencies except REFCLK	-310.0		+300.0	ps
Jitter, One Sigma	$T_{j1s}^*$	REFCLK only		200.0	250.0	ps
Jitter, Absolute	$T_{jab}^*$	REFCLK only	-500.0		+500.0	ps
Input Frequency Range	$F_i^*$		5.0		43.0	MHz
Output Frequency Range	$F_o^*$		14.0		114.0	MHz
Output Mean Frequency Accuracy vs.Target	$F_{oa}^*$	With 14.318 MHz input	-80.0		+80.0	ppm
Power-up Time	$T_{pu}^*$	0 to 33.8 MHz		2.5	4.5	ms
Crystal Input Capacitance	$C_{inx}^*$	X1 (Pin 1), X2 (Pin 8)		18.0		pF

\* Parameter is guaranteed by design and characterization. Not 100% tested in production.

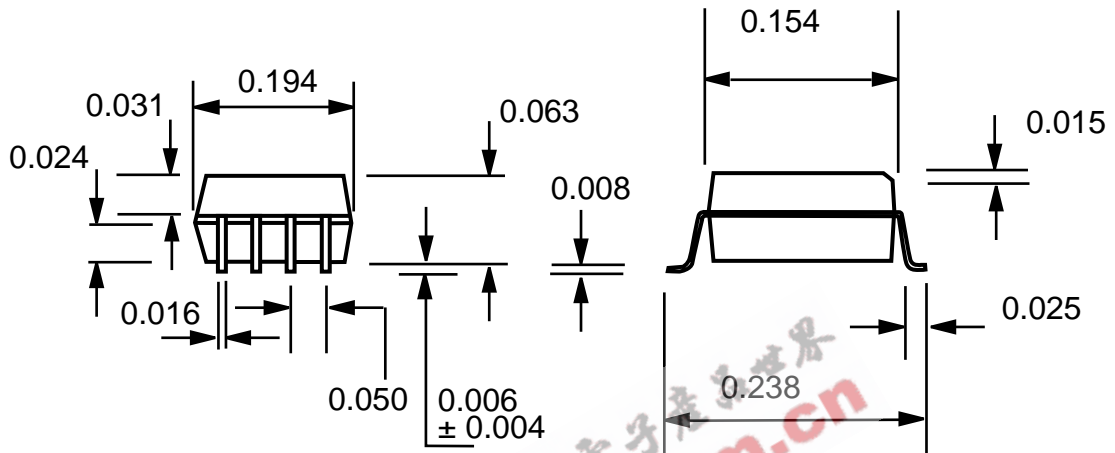
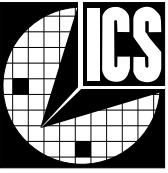

8-Pin SOIC

### Ordering Information

ICS9117M-01

Example:

ICS XXXX M-PPP

