

HiPerFETs

The HiPerFET family of Power MOSFETs is designed to provide superior dv/dt performance while eliminating the need for discrete, fast recovery "free wheeling" rectifiers in a broad range of power switching applications.

This new class of Power MOSFETs uses IXYS' HDMOS II process which improves the ruggedness of the FET while reducing the reverse recovery time of the intrinsic rectifier to less than 250 ns at elevated (150°C) junction temperature. The performance of the intrinsic rectifier is comparable to discrete high voltage rectifiers and is tailored to minimize power dissipation and stress in the MOSFET

HiPerFETs Offer Extended dv/dt Ruggedness

The HiPerFET series of Power MOSFETs have an extended stress capability in applications where the intrinsic "free-wheeling" diode is used. Both static and commutating dv/dt withstand capability have been improved tenfold to typically 50V/ns and 15V/ns respectively. These devices offer a significant margin of safety in high stress conditions found in many types of inductive power switching applications.

HDMOS II Eliminates Tradeoffs

HDMOS II is a fifth generation power MOS technology developed by IXYS which incorporates the advantages of the original HDMOS process to achieve ultra low $R_{DS(ON)}$, high unclamped energy, and high transconductance. Additionally, HDMOS II includes proprietary lifetime control process to reduce the recovery time (t_{rr}) of the intrinsic rectifier without increasing the on-resistance of the MOSFET. Also contained are enhancements to the MOSFET cell design which significantly improves dv/dt ruggedness.

HiPerFETs Range From 450 to 1000 Volts

IXYS offers the broadest range of MOSFETs with high dv/dt rugged and usable diode characteristics. They are available in ratings of 20 amps at 500 volts and 12 amps at 1000 volts. Even if the application does not require use of the intrinsic rectifier, HiPerFETs offer an extra measure of reliability in harsh industrial circuit environments such as DC motor controls, welders, sonar amplifier and other Hi-Rel/military power conversion systems.

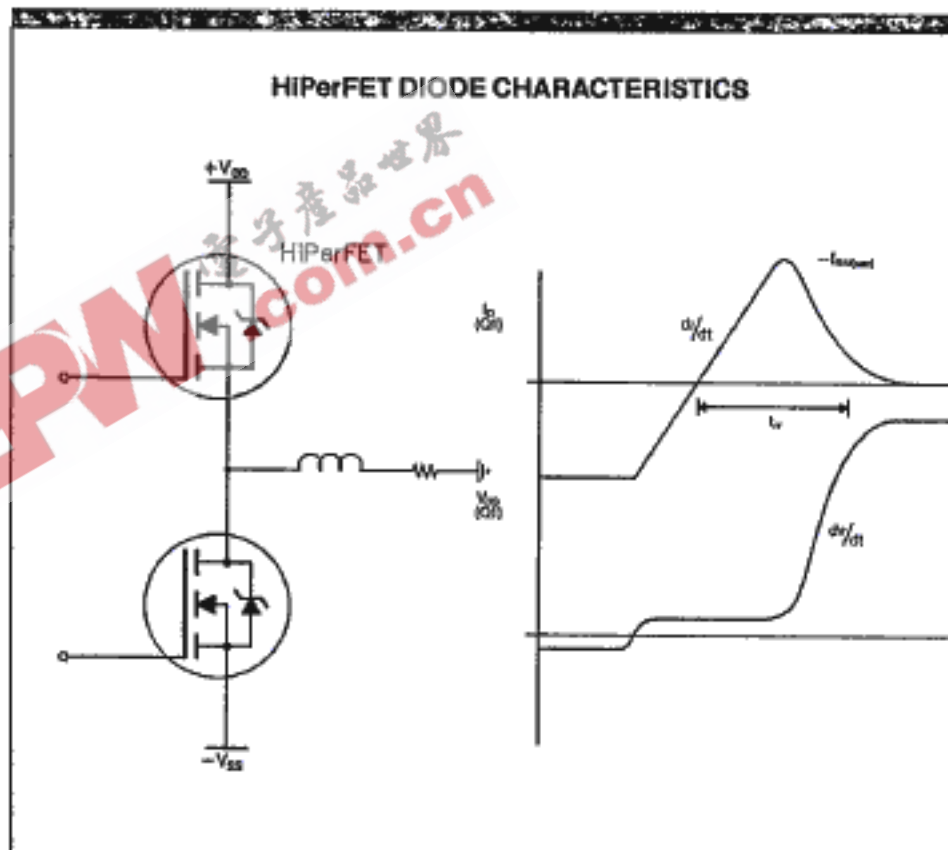

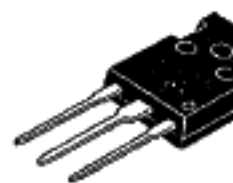

HiPerFET Power MOSFETs

Part Number	Drain-Source Voltage $V_{DS(ROSS)}$ (Volts)	Drain Current $I_{D(Cont)}$ (Amps)	On Resistance $R_{DS(on)}$ (Ohms)	HiPerFET Characteristics			Power Diss. P_D Max (Watts)	Notes	Case Style
				Diode Rec Time t_{rr} (nS)	Avalanche Current loss (Amps)	Commutating dv/dt (V/nS)			
IXFH12N100	1000	12	1.0	250	12	10	300		TO-247
IXFH11N100	1000	11	1.15	250	11	10	300		
IXFH10N100	1000	10	1.2	250	10	10	250		
IXFH9N100	1000	9	1.4	250	9	10	250		
IXFH6N100	1000	6	2.0	250	6	10	150		
IXFH5N100	1000	5	2.6	250	5	10	150		
IXFH13N90	900	13	0.8	250	13	10	300		
IXFH12N90	900	12	0.9	250	12	10	300		
IXFH11N90	900	11	0.95	250	11	10	250		
IXFH10N90	900	10	1.1	250	10	10	250		
IXFH7N90	900	7	1.5	250	7	10	150		
IXFH6N90	900	6	2.2	250	6	10	150		
IXFH18N65	650	18	0.4	250	18	10	300		
IXFH17N65	650	17	0.45	250	17	10	300		
IXFH15N65	650	15	0.5	250	15	10	250		
IXFH13N65	650	13	0.65	250	13	10	250		
IXFH10N65	650	10	0.7	250	10	10	150		
IXFH8N65	650	8	0.95	250	8	10	150		
IXFH21N60	600	21	0.3	250	21	10	300		
IXFH20N60	600	20	0.35	250	20	10	300		
IXFH17N60	600	17	0.4	250	17	10	250		
IXFH15N60	600	15	0.5	250	15	10	250		
IXFH11N60	600	11	0.55	250	11	10	150		
IXFH10N60	600	10	0.75	250	10	10	150		
IXFH26N50	500	26	0.2	250	26	10	300		
IXFH24N50	500	24	0.23	250	24	10	300		
IXFH21N50	500	21	0.25	250	21	10	250		
IXFH19N50	500	19	0.3	250	19	10	250		
IXFH13N50	500	13	0.4	250	13	10	150		
IXFH12N50	500	12	0.5	250	12	10	150		
IXFH40N30	300	40	0.08	250	40	10	250		
IXFH35N30	300	35	0.1	250	35	10	250		
IXFH50N20	200	50	0.045	200	50	10	250		
IXFH42N20	200	42	0.065	200	42	10	250		
IXFH75N10	100	75	0.02	200	75	10	250		
IXFH67N10	100	67	0.025	200	67	10	250		

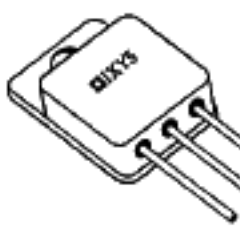

HIPerFET Power MOSFETs

Part Number	Drain-Source Voltage $V_{DS(oss)}$ (Volts)	Drain Current $I_D(Cont)$ (Amps)	On Resistance $R_{DS(on)}$ (Ohms)	HIPerFET Characteristics			Power Diss. P_D Max (Watts)	Notes	Case Style
				Diode Rec Time t_{rr} (nS)	Avalanche Current I_{AS} (Amps)	Commutating dv/dt (V/nS)			
IXFL13N65	650	13	0.5	250	13	10	175		
IXFL9N65	650	9	0.7	250	9	10	125		
IXFL14N60	600	14	0.4	250	14	10	175		
IXFL10N60	600	10	0.55	250	10	10	125		
IXFL18N50	500	18	0.25	250	18	10	175		
IXFL450	500	12	0.4	250	12	10	125		
IXFL24N40	400	24	0.2	250	24	10	175		
IXFL350	400	14	0.3	250	14	10	125		
IXFL25N20	200	25	0.065	200	25	10	175		
IXFL250	200	25	0.1	200	25	10	125		
IXFL25N10	100	25	0.030	200	25	10	175		
IXFL150	100	25	0.065	200	25	10	125		
IXFM12N100	1000	12	1.0	250	12	10	300		
IXFM11N100	1000	11	1.15	250	11	10	300		
IXFM10N100	1000	10	1.2	250	10	10	250		
IXFM9N100	1000	9	1.4	250	9	10	250		
IXFM8N100	1000	6	2.0	250	6	10	150		
IXFM5N100	1000	5	2.6	250	5	10	150		
IXFM13N90	900	13	0.8	250	13	10	300		
IXFM12N90	900	12	0.9	250	12	10	300		
IXFM11N90	900	11	0.95	250	11	10	250		
IXFM10N90	900	10	1.1	250	10	10	250		
IXFM7N90	900	7	1.5	250	7	10	150		
IXFM6N90	900	6	2.2	250	6	10	150		
IXFM18N65	650	18	0.4	250	18	10	300		
IXFM17N65	650	17	0.45	250	17	10	300		
IXFM15N65	650	15	0.5	250	15	10	250		
IXFM13N65	650	13	0.65	250	13	10	250		
IXFM10N65	650	10	0.7	250	10	10	150		
IXFM9N65	650	8	0.95	250	8	10	150		
IXFM21N60	600	21	0.3	250	21	10	300		
IXFM20N60	600	20	0.35	250	20	10	300		
IXFM17N60	600	17	0.4	250	17	10	250		
IXFM15N60	600	15	0.5	250	15	10	250		
IXFM11N60	600	11	0.55	250	11	10	150		
IXFM10N60	600	10	0.75	250	10	10	150		
IXFM26N50	500	26	0.2	250	26	10	300		

HIPerFET Power MOSFETs

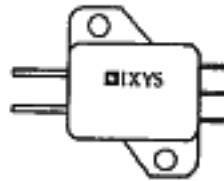
Part Number	Drain-Source Voltage $V_{DS(ON)}$ (Volts)	Drain Current $I_{D(ON)}$ (Amps)	On Resistance $R_{DS(ON)}$ (Ohms)	HIPerFET Characteristics			Power Diss. P_D Max (Watts)	Notes	Case Style
				Diode Rec Time t_r (nS)	Avalanche Current I_{AS} (Amps)	Commutating dv/dt (V/nS)			
IXFM24N50	500	24	0.23	250	24	10	300		
IXFM21N50	500	21	0.25	250	21	10	250		
IXFM19N50	500	19	0.3	250	19	10	250		
IXFM13N50	500	13	0.4	250	13	10	150		
IXFM12N50	500	12	0.5	250	12	10	150		
IXFM40N30	300	40	0.08	250	40	10	250		
IXFM35N30	300	35	0.1	250	35	10	250		
IXFM50N20	200	50	0.045	200	50	10	250		
IXFM42N20	200	42	0.065	200	42	10	250		
IXFM75N10	100	75	0.02	200	75	10	250		
IXFM67N10	100	67	0.025	200	67	10	250		
IXFZ11N100	1000	11	1.15	250	11	10	300		
IXFZ12N90	900	12	0.9	250	12	10	300		
IXFZ18N65	650	18	0.4	250	18	10	300		
IXFZ21N60	600	21	0.3	250	21	10	300		
IXFZ24N50	500	24	0.23	250	24	10	300		
IXFZ35N30	300	35	0.1	250	35	10	250		
IXFZ42N20	200	42	0.065	200	42	10	250		
IXFZ67N10	100	67	0.025	200	67	10	250		
IXFN15N100	1000	15	0.6	250	---	10	325		1
IXFN17N80	800	17	0.5	250	---	10	325	1	
IXFN35N50	500	35	0.12	250	35	10	325	1	
IXFN50N25	250	50	0.05	250	50	10	300	1	
IXFN64N20	200	64	0.033	250	64	10	300		
IXFN100N10	100	100	0.013	250	100	10	300		

Notes: 1. Available 4Q89

DETAILED PACKAGE OUTLINES

T-91-20

TO-220 AB

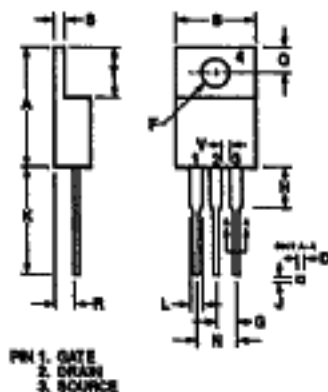

PIN 1. GATE
2. DRAIN
3. SOURCE

Dim.	Millimeter		Inches	
	Min.	Max.	Min.	Max.
A	14.23	16.51	.560	.650
B	9.65	10.65	.380	.420
C	3.56	4.82	.140	.190
D	0.64	0.89	.025	.035
F	3.54	4.00	.139	.161
G	2.29	2.79	.090	.110
H	-	6.35	-	.250
J	0.51	.76	.020	.030
K	12.79	14.73	.500	.580
L	1.15	1.77	.045	.070
N	4.83	5.33	.190	.210
Q	2.54	3.42	.100	.135
R	2.64	2.49	.060	.115
S	0.64	1.39	.025	.055
T	5.85	6.85	.230	.270
V	1.15	-	.045	-

CONFORMS TO OUTLINE TO-220 (IR H-7)
Dimensions in Millimeters (Inches)

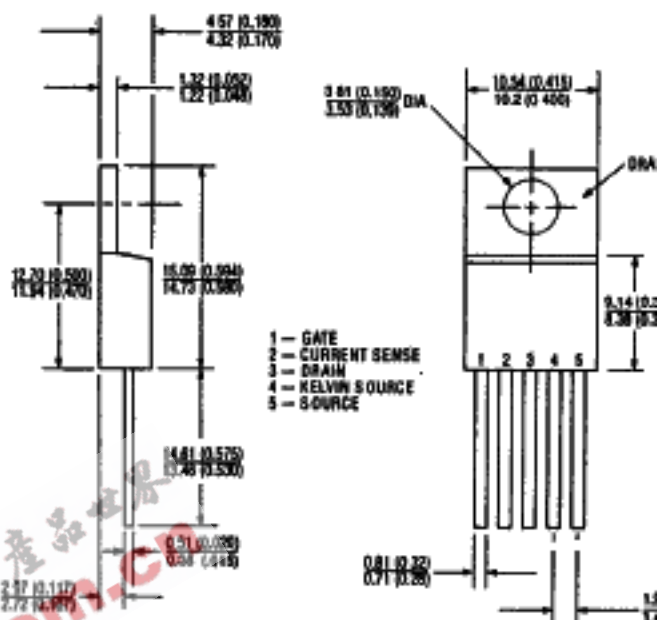

1 - GATE
2 - CURRENT SENSE
3 - DRAIN
4 - KELVIN SOURCE
5 - SOURCE

TO-247 (3 LEADED)

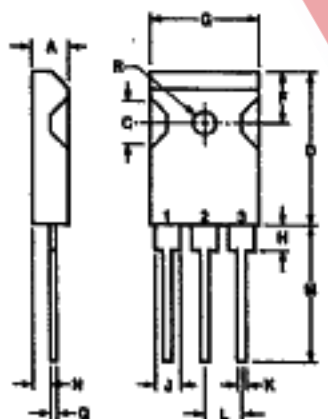

PIN 1. GATE
2. DRAIN
3. SOURCE

Dim.	Millimeter		Inches	
	Min.	Max.	Min.	Max.
A	4.7	5.3	.185	.209
C	4.5	6.0	.178	.236
D	19.7	21.4	.776	.843
F	5.3	6.1	.209	.240
G	15.3	15.9	.602	.625
H	3.7	4.3	.146	.169
J	1.95	2.4	.077	.094
J ₁	2.97	3.4	.117	.134
K	1.0	1.4	.040	.055
L	5.4	5.5	.213	.217
M	19.9	20.2	.783	.795
N	2.2	2.6	.087	.102
Q	0.4	0.8	.016	.031
R	2.9	3.3	.114	.129

TO-247 (5 LEADED)

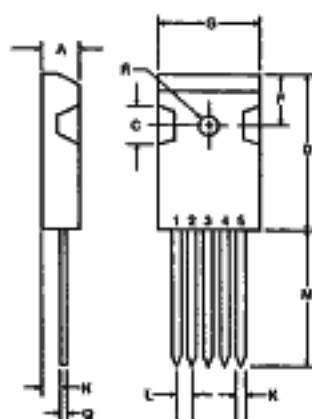

PIN 1. GATE
2. MIRROR
3. DRAIN
4. KELVIN
5. SOURCE

Dim.	Millimeter		Inches	
	Min.	Max.	Min.	Max.
A	4.7	5.3	.185	.209
C	4.5	6.0	.178	.236
D	19.7	21.4	.776	.843
F	5.3	6.1	.209	.240
G	15.3	15.9	.602	.625
K	1.1	1.3	.043	.050
L	2.61	2.58	.099	.101
M	19.9	20.2	.783	.795
N	2.2	2.6	.087	.102
Q	0.4	0.8	.016	.031
R	2.9	3.3	.114	.129

TO-238
Dimensions in Millimeters

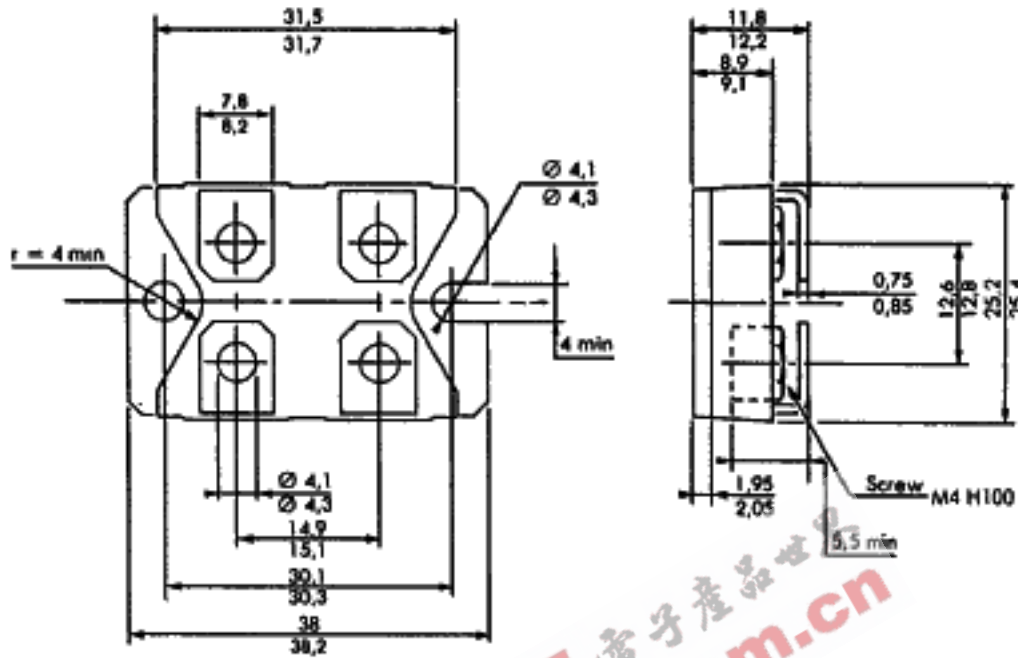

Y-4
Dimensions in Millimeters

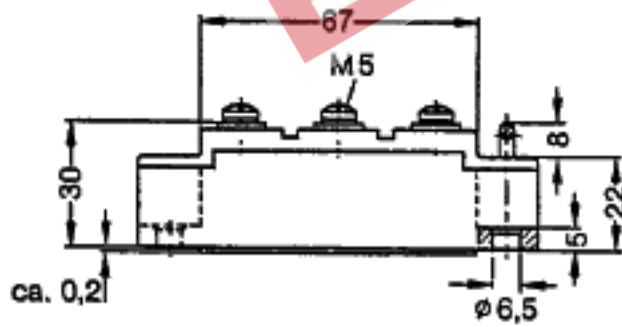

Y-3
Dimensions in Millimeters

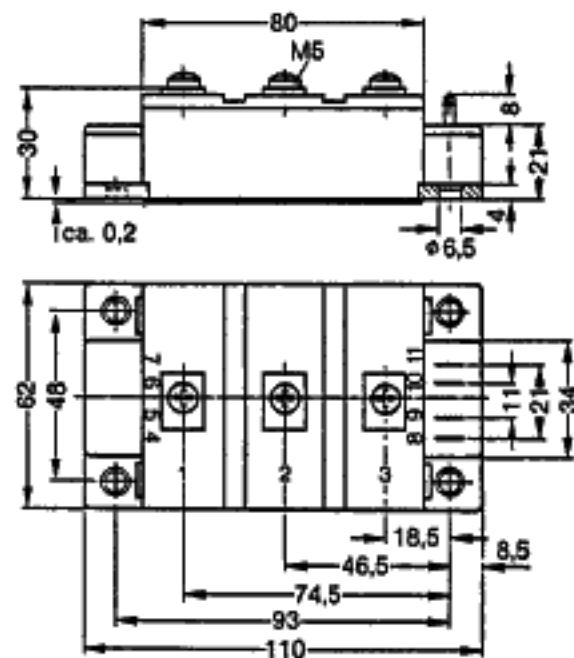

CONFORMS TO JEDEC OUTLINE TO-210AC (TO-61)
 Dimensions in Millimeters (Inches)

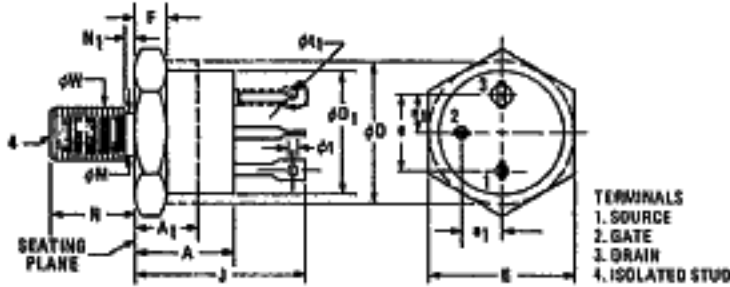

TERMINALS
 1. SOURCE
 2. GATE
 3. DRAIN
 4. ISOLATED STUD

Symbol	Inches		Millimeters		Notes
	Min.	Max.	Min.	Max.	
A	0.325	0.400	8.26	11.68	
A ₁	0.270	0.300	6.86	7.62	2
phi D	0.670	0.687	16.99	17.45	2
phi D ₁	0.570	0.610	14.48	15.40	
e	0.060	0.087	1.52	2.21	
phi	0.340	0.415	8.64	10.54	5
phi 1	0.170	0.213	4.32	5.41	5
F	0.050	0.100	1.27	2.54	1

Symbol	Inches		Millimeters		Notes
	Min.	Max.	Min.	Max.	
J	0.540	0.675	13.68	17.16	
phi M	0.720	0.748	18.29	19.00	
N	0.422	0.456	10.72	11.56	
N ₁	0.055	0.070	1.39	1.78	
phi 11	0.046	0.077	1.17	1.96	4
phi W	0.2225	0.2364	5.661	5.961	3

NOTES

1. DIMENSION DOES NOT INCLUDE SEALING FLANGES.
2. PACKAGE CONTOUR OPTIONAL WITHIN DIMENSIONS SPECIFIED.
3. PITCH DIAMETER - THREAD 1/4-28 UNF 2A COATED. REFERENCE ISCREM THREAD STANDARDS FOR FEDERAL SERVICES - HANDBOOK H-201.
4. THIS TERMINAL CAN BE FLATTENED AND PIERCED OR HOOK TYPE.
5. POSITION OF LEADS IN RELATION TO THE HEXAGON IS NOT CONTROLLED.

QUADPAC

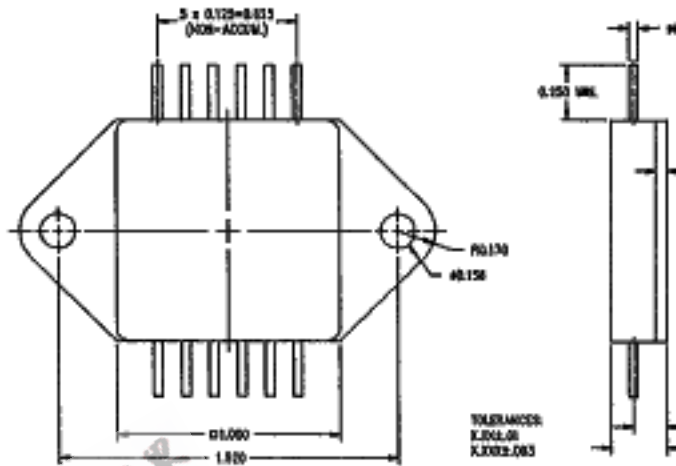

TOLERANCES:
 X.XXX±.01
 X.XXX±.005

电子產品世界
 www.eepw.com.cn

Z-Pac



TOLERANCES:
 X.XXX±.01
 X.XXX±.005

