

# IGBT with optional Diode

**IXDP 35N60 B**  
**IXDH 35N60 B**  
**IXDH 35N60 BD1**

**V<sub>CES</sub> = 600 V**  
**I<sub>C25</sub> = 60 A**  
**V<sub>CE(sat) typ</sub> = 2.1 V**

High Speed,  
Low Saturation Voltage

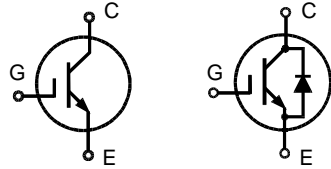

IXDH 35N60 B IXDH 35N60 BD1  
IXDP 35N60 B

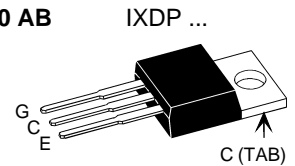
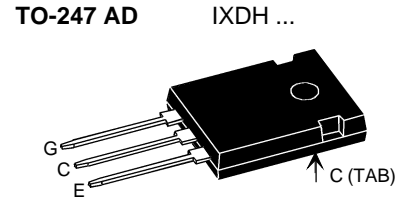

G = Gate,  
C = Collector ,  
E = Emitter  
TAB = Collector

Symbol	Conditions	Maximum Ratings	
V <sub>CES</sub>	T <sub>J</sub> = 25°C to 150°C	600	V
V <sub>CGR</sub>	T <sub>J</sub> = 25°C to 150°C; R <sub>GE</sub> = 20 kΩ	600	V
V <sub>GES</sub>	Continuous	±20	V
V <sub>GEM</sub>	Transient	±30	V
I <sub>C25</sub>	T <sub>C</sub> = 25°C	60	A
I <sub>C90</sub>	T <sub>C</sub> = 90°C	35	A
I <sub>CM</sub>	T <sub>C</sub> = 90°C, t <sub>p</sub> = 1 ms	70	A
RBSOA	V <sub>GE</sub> = ±15 V, T <sub>J</sub> = 125°C, R <sub>G</sub> = 10 Ω Clamped inductive load, L = 30 μH	I <sub>CM</sub> = 110 V <sub>CEK</sub> < V <sub>CES</sub>	A
t <sub>SC</sub> (SCSOA)	V <sub>GE</sub> = ±15 V, V <sub>CE</sub> = 600 V, T <sub>J</sub> = 125°C R <sub>G</sub> = 10 Ω, non repetitive	10	μs
P <sub>C</sub>	T <sub>C</sub> = 25°C	IGBT Diode	250 80 W W
T <sub>J</sub>		-55 ... +150	°C
T <sub>stg</sub>		-55 ... +150	°C
	Maximum lead temperature for soldering 1.6 mm (0.062 in.) from case for 10 s	300	°C
M <sub>d</sub>	Mounting torque	TO-220 TO-247	0.4 - 0.6 0.8 - 1.2 Nm Nm
Weight			6 g

## Features

- NPT IGBT technology
- low switching losses
- low tail current
- no latch up
- short circuit capability
- positive temperature coefficient for easy paralleling
- MOS input, voltage controlled
- optional ultra fast diode
- International standard package

## Advantages

- Space savings
- High power density

## Typical Applications

- AC motor speed control
- DC servo and robot drives
- DC choppers
- Uninterruptible power supplies (UPS)
- Switch-mode and resonant-mode power supplies

Symbol	Conditions	Characteristic Values (T <sub>J</sub> = 25°C, unless otherwise specified)		
		min.	typ.	max.
V <sub>(BR)CES</sub>	V <sub>GE</sub> = 0 V	600		V
V <sub>GE(th)</sub>	I <sub>C</sub> = 0.7 mA, V <sub>CE</sub> = V <sub>GE</sub>	3		5 V
I <sub>CES</sub>	V <sub>CE</sub> = V <sub>CES</sub>		T <sub>J</sub> = 25°C T <sub>J</sub> = 125°C	0.1 mA mA
I <sub>GES</sub>	V <sub>CE</sub> = 0 V, V <sub>GE</sub> = ±20 V			± 500 nA
V <sub>CE(sat)</sub>	I <sub>C</sub> = 35 A, V <sub>GE</sub> = 15 V	2.2	2.7	V

Symbol	Conditions	Characteristic Values ( $T_J = 25^\circ\text{C}$ , unless otherwise specified)		
		min.	typ.	max.
$C_{ies}$	$V_{CE} = 25\text{ V}, V_{GE} = 0\text{ V}, f = 1\text{ MHz}$		1600	pF
$C_{oes}$			150	pF
$C_{res}$			90	pF
$Q_g$	$I_C = 35\text{ A}, V_{GE} = 15\text{ V}, V_{CE} = 480\text{ V}$		120	nC
$t_{d(on)}$	<b>Inductive load, <math>T_J = 125^\circ\text{C}</math></b> $I_C = 35\text{ A}, V_{GE} = \pm 15\text{ V},$ $V_{CE} = 300\text{ V}, R_G = 10\ \Omega$		30	ns
$t_r$			45	ns
$t_{d(off)}$			320	ns
$t_f$			70	ns
$E_{on}$			1.6	mJ
$E_{off}$		0.8	mJ	
$R_{thJC}$				0.5 K/W
$R_{thCH}$	TO 247 Package with heatsink compound		0.25	K/W
$R_{thCH}$	TO 220 Package with heatsink compound		0.5	K/W

**Reverse Diode (FRED) [D1 version only]**
**Characteristic Values**  
( $T_J = 25^\circ\text{C}$ , unless otherwise specified)

Symbol	Conditions	Characteristic Values	
		min.	max.
$V_F$	$I_F = 35\text{ A}, V_{GE} = 0\text{ V}$	2.1	2.4 V
	$I_F = 35\text{ A}, V_{GE} = 0\text{ V}, T_J = 125^\circ\text{C}$	1.6	V
$I_F$	$T_C = 25^\circ\text{C}$		45 A
	$T_C = 90^\circ\text{C}$		25 A
$I_{RM}$	$I_F = 15\text{ A}, -di_F/dt = 400\text{ A}/\mu\text{s}, V_R = 300\text{ V}$	13	A
$t_{rr}$	$V_{GE} = 0\text{ V}, T_J = 125^\circ\text{C}$	90	ns
$t_{rr}$	$I_F = 1\text{ A}, -di_F/dt = 100\text{ A}/\mu\text{s}, V_R = 30\text{ V}, V_{GE} = 0\text{ V}$	40	ns
$R_{thJC}$			1.6 K/W

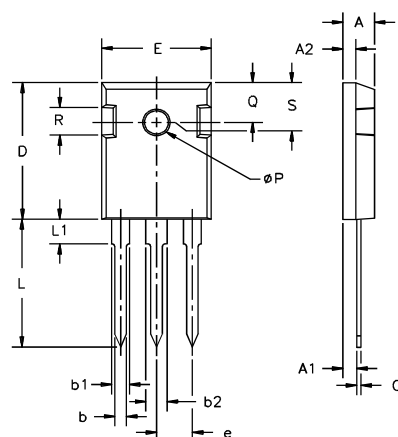
**TO-247 AD Outline**

Dim.	Millimeter		Inches	
	Min.	Max.	Min.	Max.
A	4.7	5.3	.185	.209
A <sub>1</sub>	2.2	2.54	.087	.102
A <sub>2</sub>	2.2	2.6	.059	.098
b	1.0	1.4	.040	.055
b <sub>1</sub>	1.65	2.13	.065	.084
b <sub>2</sub>	2.87	3.12	.113	.123
C	.4	.8	.016	.031
D	20.80	21.46	.819	.845
E	15.75	16.26	.610	.640
e	5.20	5.72	0.205	0.225
L	19.81	20.32	.780	.800
L1		4.50		.177
∅P	3.55	3.65	.140	.144
Q	5.89	6.40	0.232	0.252
R	4.32	5.49	.170	.216
S	6.15 BSC		242 BSC	

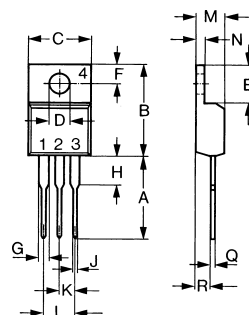
**TO-220 AB Outline**

Dim.	Millimeter		Inches	
	Min.	Max.	Min.	Max.
A	12.70	13.97	0.500	0.550
B	14.73	16.00	0.580	0.630
C	9.91	10.66	0.390	0.420
D	3.54	4.08	0.139	0.161
E	5.85	6.85	0.230	0.270
F	2.54	3.18	0.100	0.125
G	1.15	1.65	0.045	0.065
H	2.79	5.84	0.110	0.230
J	0.64	1.01	0.025	0.040
K	2.54	BSC	0.100	BSC
M	4.32	4.82	0.170	0.190
N	1.14	1.39	0.045	0.055
Q	0.35	0.56	0.014	0.022
R	2.29	2.79	0.090	0.110

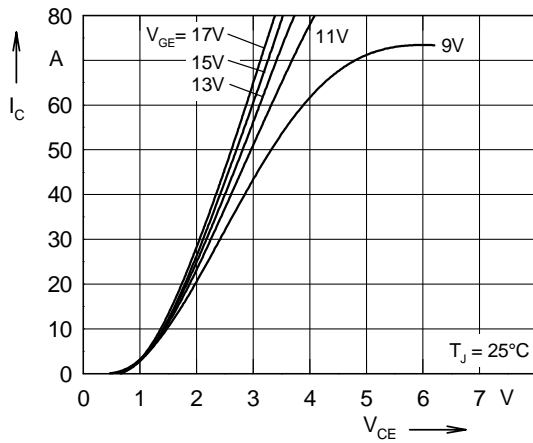

Fig. 1 Typ. output characteristics

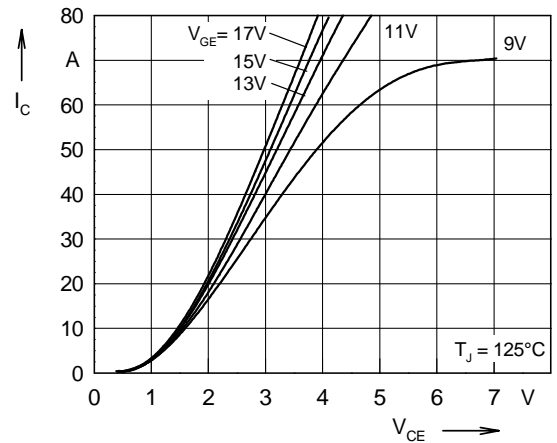

Fig. 2 Typ. output characteristics

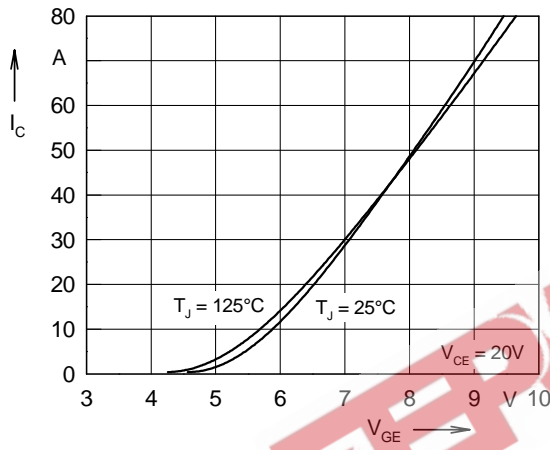

Fig. 3 Typ. transfer characteristics

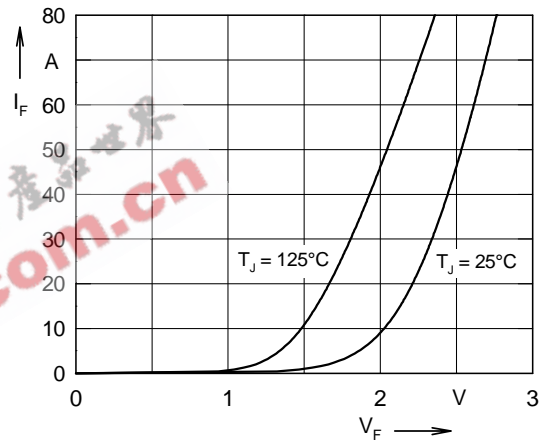

Fig. 4 Typ. forward characteristics of free wheeling diode

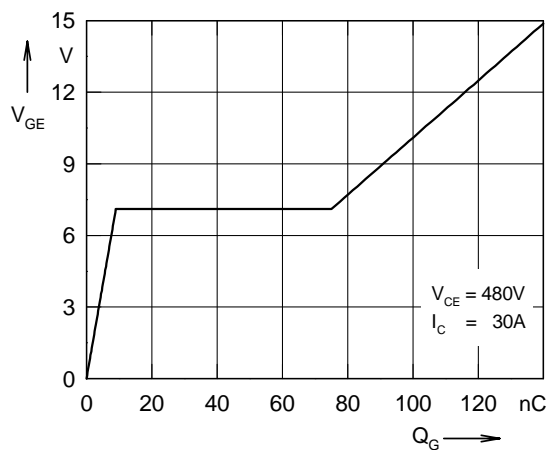

Fig. 5 Typ. turn on gate charge

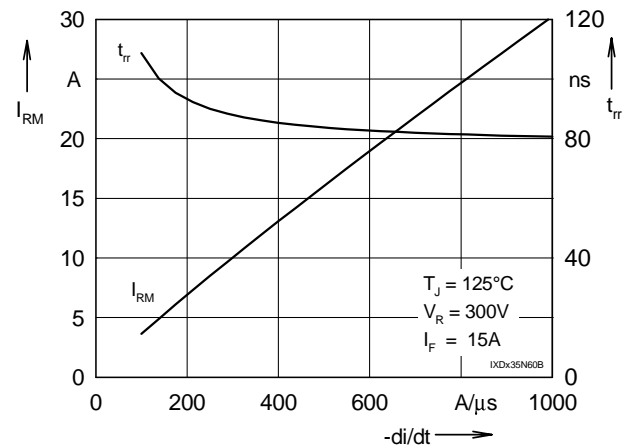

Fig. 6 Typ. turn off characteristics of free wheeling diode

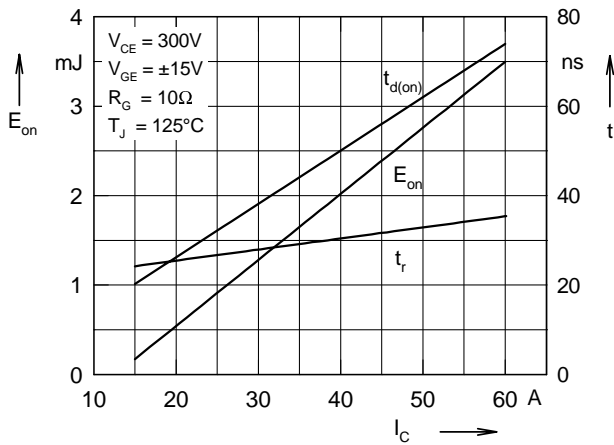

Fig. 7 Typ. turn on energy and switching times versus collector current

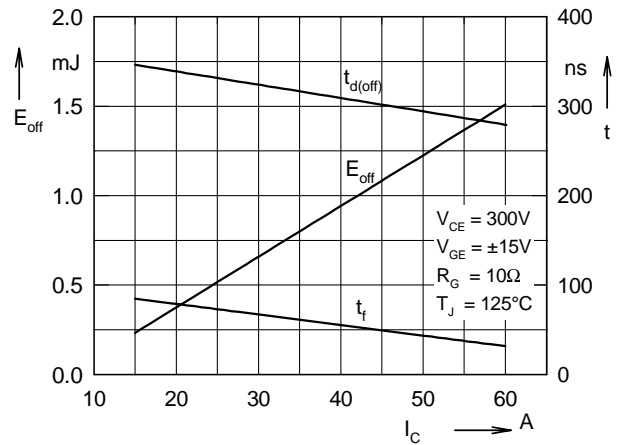

Fig. 8 Typ. turn off energy and switching times versus collector current

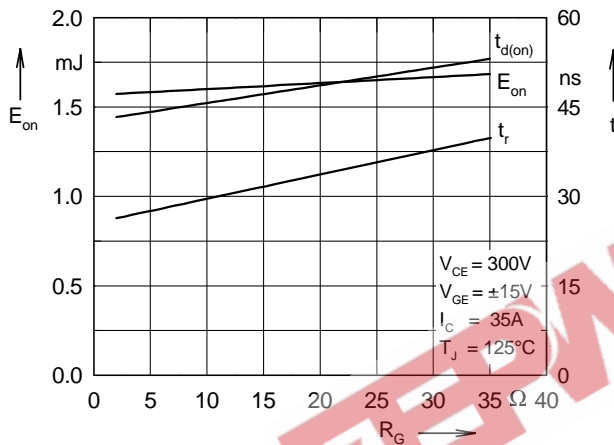

Fig. 9 Typ. turn on energy and switching times versus gate resistor

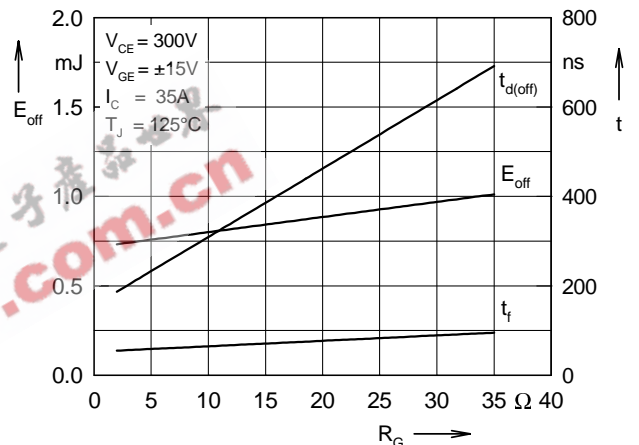

Fig.10 Typ. turn off energy and switching times versus gate resistor

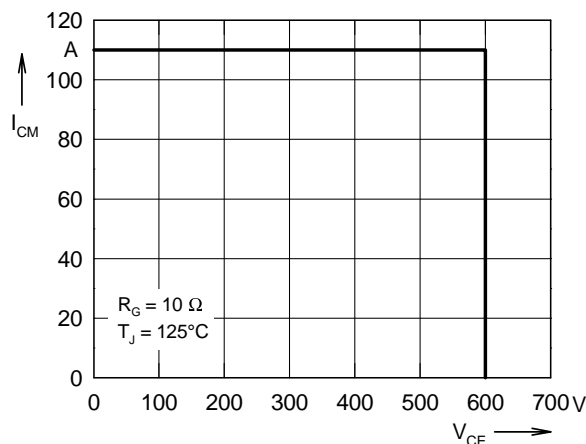

Fig. 11 Reverse biased safe operating area RBSOA

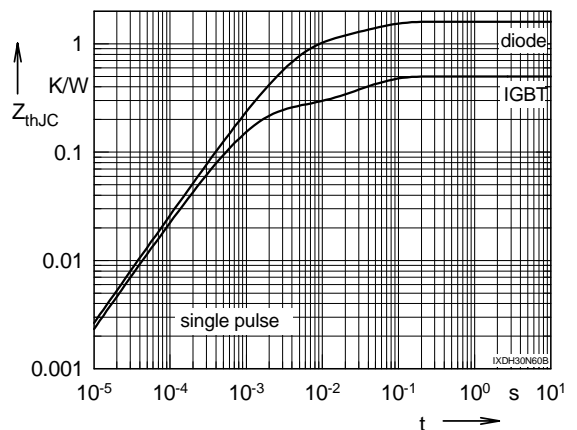

Fig. 12 Typ. transient thermal impedance