

IW4066B

Quad Bilateral Switch  
High-Voltage Silicon-Gate CMOS

The IW4066B is a quad bilateral switch intended for the transmission or multiplexing of analog or digital signals. In addition, the on-state resistance is relatively constant over the full input-signal range.

The IW4066B consists of four independent bilateral switches. A single control signal is required per switch. Both the p and the n device in a given switch are biased on or off simultaneously by the control signal. (As show in Fig.1.)The well of the n-channel device on each switch is either tied to the input when the switch is on or to GND when the switch is off. This configuration eliminates the variation of the switch-transistor threshold voltage with input signal, and thus keeps the on-state resistance low over the full operating-signal range.

The advantages over single-channel switches include peak input-signal voltage swings equal to the full supply voltage, and more constant on-state impedance over the input-signal range.

- Operating Voltage Range: 3.0 to 18 V
- Maximum input current of 1  $\mu$ A at 18 V over full package-temperature range; 100 nA at 18 V and 25°C
- Noise margin (over full package temperature range):
  - 1.0 V min @ 5.0 V supply
  - 2.0 V min @ 10.0 V supply
  - 2.5 V min @ 15.0 V supply

**ORDERING INFORMATION**  
IW4066BN Plastic  
IW4066BD SOIC  
 $T_A = -55^\circ$  to  $125^\circ$  C for all packages

LOGIC DIAGRAM

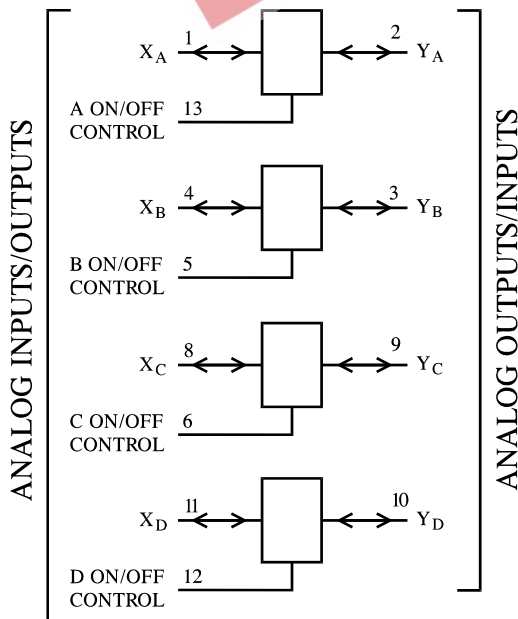

PIN 14 =  $V_{CC}$   
PIN 7 = GND

PIN ASSIGNMENT

$X_A$	1	14	$V_{CC}$
$Y_A$	2	13	A ON/OFF CONTROL
$Y_B$	3	12	D ON/OFF CONTROL
$X_B$	4	11	$X_D$
B ON/OFF CONTROL	5	10	$Y_D$
C ON/OFF CONTROL	6	9	$Y_C$
GND	7	8	$X_C$

FUNCTION TABLE

On/Off Control Input	State of Analog Switch
L	Off
H	On

**MAXIMUM RATINGS\***

Symbol	Parameter	Value	Unit
V <sub>CC</sub>	DC Supply Voltage (Referenced to GND)	-0.5 to +20	V
V <sub>IN</sub>	DC Input Voltage (Referenced to GND)	-0.5 to V <sub>CC</sub> +0.5	V
V <sub>OUT</sub>	DC Output Voltage (Referenced to GND)	-0.5 to V <sub>CC</sub> +0.5	V
I <sub>IN</sub>	DC Input Current, per Pin	±10	mA
P <sub>D</sub>	Power Dissipation in Still Air, Plastic DIP+ SOIC Package+	750 500	mW
P <sub>D</sub>	Power Dissipation per Output Transistor	100	mW
T <sub>stg</sub>	Storage Temperature	-65 to +150	°C
T <sub>L</sub>	Lead Temperature, 1 mm from Case for 10 Seconds (Plastic DIP or SOIC Package)	260	°C

\*Maximum Ratings are those values beyond which damage to the device may occur. Functional operation should be restricted to the Recommended Operating Conditions.

+Derating - Plastic DIP: - 10 mW/°C from 65° to 125°C

SOIC Package: - 7 mW/°C from 65° to 125°C

**RECOMMENDED OPERATING CONDITIONS**

Symbol	Parameter	Min	Max	Unit
V <sub>CC</sub>	DC Supply Voltage (Referenced to GND)	3.0	18	V
V <sub>IN</sub> , V <sub>OUT</sub>	DC Input Voltage, Output Voltage (Referenced to GND)	0	V <sub>CC</sub>	V
T <sub>A</sub>	Operating Temperature, All Package Types	-55	+125	°C

This device contains protection circuitry to guard against damage due to high static voltages or electric fields. However, precautions must be taken to avoid applications of any voltage higher than maximum rated voltages to this high-impedance circuit. For proper operation, V<sub>IN</sub> and V<sub>OUT</sub> should be constrained to the range GND ≤ (V<sub>IN</sub> or V<sub>OUT</sub>) ≤ V<sub>CC</sub>.

Unused inputs must always be tied to an appropriate logic voltage level (e.g., either GND or V<sub>CC</sub>). Unused outputs must be left open.

## DC ELECTRICAL CHARACTERISTICS (Voltages Referenced to GND)

Symbol	Parameter	Test Conditions	V <sub>CC</sub> V	Guaranteed Limit			Unit
				≥-55°C	25 °C	≤125 °C	
V <sub>IH</sub>	Minimum High-Level Voltage ON/Off Control Inputs	R <sub>ON</sub> = Per Spec	5.0 10 15	3.5(Min) 7(Min) 11(Min)			V
V <sub>IL</sub>	Minimum Low-Level Voltage ON/Off Control Inputs	R <sub>ON</sub> = Per Spec	5.0 10 15	1 2 2	1 2 2	1 2 2	V
I <sub>IN</sub>	Maximum Input Leakage Current, ON/OFF Control Inputs	V <sub>IN</sub> = V <sub>CC</sub> or GND	18	±0.1	±0.1	±1.0	μA
I <sub>CC</sub>	Maximum Quiescent Supply Current (per Package)	V <sub>IN</sub> = V <sub>CC</sub> or GND	5.0 10 15 20	0.25 0.5 1 5	0.25 0.5 1 5	7.5 15 30 150	μA
R <sub>ON</sub>	Maximum "ON" Resistance	V <sub>C</sub> = V <sub>CC</sub> R <sub>L</sub> = 10 kΩ returned to $\frac{V_{CC} - GND}{2}$ V <sub>IS</sub> = GND to V <sub>CC</sub>	5.0 10 15	800 310 200	1050 400 240	1300 550 320	Ω
ΔR <sub>ON</sub>	Maximum Difference in "ON" Resistance Between Any Two Channels in the Same Package	V <sub>C</sub> = V <sub>CC</sub> R <sub>L</sub> = 10 kΩ	5.0 10 15	- - -	15 10 5	- - -	Ω
I <sub>OFF</sub>	Maximum Off-Channel Leakage Current, Any One Channel	V <sub>C</sub> = 0 V V <sub>IS</sub> = 18 V; V <sub>OS</sub> = 0 V V <sub>IS</sub> = 0 V; V <sub>OS</sub> = 18 V	18	±0.1	±0.1	±1.0	μA
I <sub>ON</sub>	Maximum On-Channel Leakage Current, Any One Channel	V <sub>C</sub> = 0 V V <sub>IS</sub> = 18 V; V <sub>OS</sub> = 0 V V <sub>IS</sub> = 0 V; V <sub>OS</sub> = 18 V	18	±0.1	±0.1	±1.0	μA

**AC ELECTRICAL CHARACTERISTICS** ( $C_L=50\text{pF}$ ,  $R_L=200\text{k}\Omega$ , Input  $t_r=t_f=20\text{ ns}$ )

Symbol	Parameter	V <sub>CC</sub> V	Guaranteed Limit			Unit
			≥-55°C	25°C	≤125°C	
t <sub>PLH</sub> , t <sub>PHL</sub>	Maximum Propagation Delay, Analog Input to Analog Output (Figure 2)	5.0	40	40	80	ns
		10	20	20	40	
		15	15	15	30	
t <sub>PLZ</sub> , t <sub>PHZ</sub> , t <sub>PZL</sub> , t <sub>PZH</sub>	Maximum Propagation Delay, ON/OFF Control to Analog Output (Figure 3)	5.0	70	70	140	ns
		10	40	40	80	
		15	30	30	60	
C	Maximum Capacitance ON/OFF Control Input Control Input = GND Analog I/O Feedthrough	-		15		pF
				7.5		
				0.6		

**ADDITIONAL APPLICATION CHARACTERISTICS** (Voltages Referenced to GND Unless Noted)

Symbol	Parameter	Test Conditions	V <sub>CC</sub> V	Limit* 25°C	Unit
THD	Total Harmonic Distortion	V <sub>C</sub> = V <sub>CC</sub> , GND = -5 V R <sub>L</sub> = 10 kΩ, f <sub>IS</sub> = 1 kHz sine wave	5	0.4	%
BW	Maximum On-Channel Bandwidth or Minimum Frequency Response	V <sub>C</sub> = V <sub>CC</sub> , GND = -5 V R <sub>L</sub> = 1 kΩ	5	40	MHz
BW	Maximum On-Channel Bandwidth or Minimum Frequency Response	V <sub>C</sub> = GND, V <sub>IS</sub> = 5 V R <sub>L</sub> = 1 kΩ	10	1	MHz
BW	Maximum On-Channel Bandwidth or Minimum Frequency Response	V <sub>C</sub> (A) = V <sub>CC</sub> = 5 V V <sub>C</sub> (B) = GND = -5 V V <sub>IS</sub> (A) = 5 V <sub>P-P</sub> , 50 Ω source R <sub>L</sub> = 1 kΩ	5	8	MHz
-	Cross talk (Control Input to Signal Output)	V <sub>C</sub> = 10 V t <sub>r</sub> , t <sub>f</sub> = 20 ns R <sub>L</sub> = 10 kΩ	10	50	mV
-	Maximum Control Input Repetition Rate	V <sub>IS</sub> = V <sub>CC</sub> , R <sub>L</sub> = 1 kΩ C <sub>L</sub> = 50 pF V <sub>C</sub> = 10 V (square wave centered on 5 V) t <sub>r</sub> , t <sub>f</sub> = 20 ns, V <sub>OS</sub> = 1/2 V <sub>OS</sub> @ 1 kHz	5 10 15	6 9 9.5	MHz

\* Guaranteed limits not tested. Determined by design and verified by qualification.



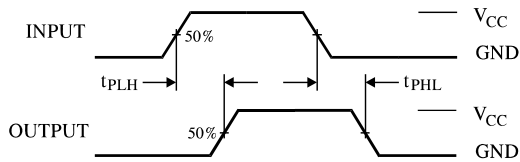

Figure 2. Switching Waveforms

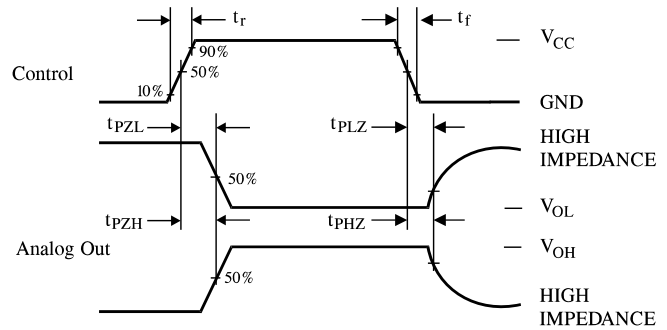
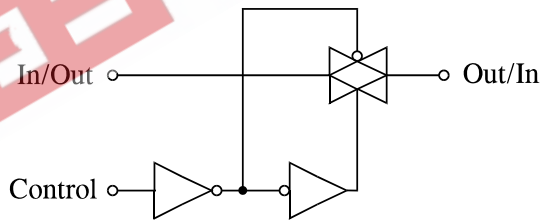

Figure 3. Switching Waveforms

**EXPANDED LOGIC DIAGRAM  
(1/4 of the Device)**



Control	Switch
GND = L	OFF
V <sub>CC</sub> = H	ON

**N SUFFIX PLASTIC DIP  
(MS - 001AA)**

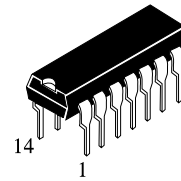
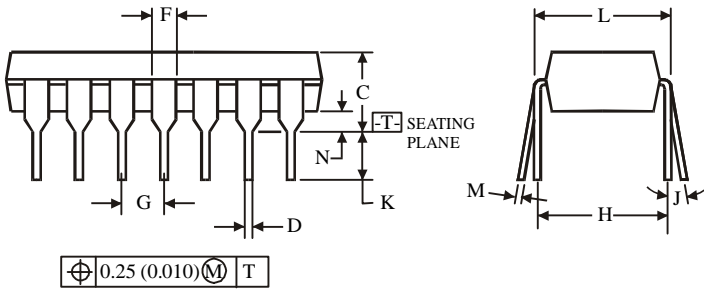
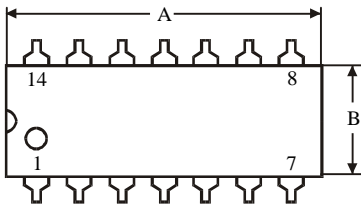

Symbol	Dimensions, mm	
	MIN	MAX
A	18.67	19.69
B	6.10	7.11
C		5.33
D	0.36	0.56
F	1.14	1.78
G	2.54	
H	7.62	
J	0°	10°
K	2.92	3.81
L	7.62	8.26
M	0.20	0.36
N	0.38	

**NOTES:**

- Dimensions "A", "B" do not include mold flash or protrusions. Maximum mold flash or protrusions 0.25 mm (0.010) per side.

**D SUFFIX SOIC  
(MS - 012AB)**

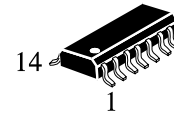
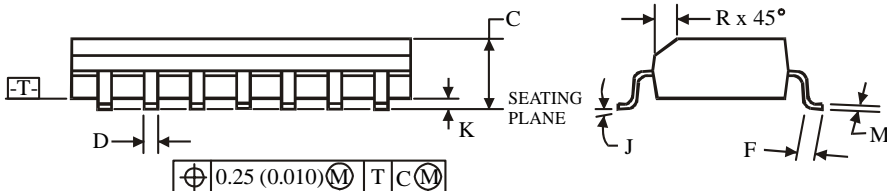
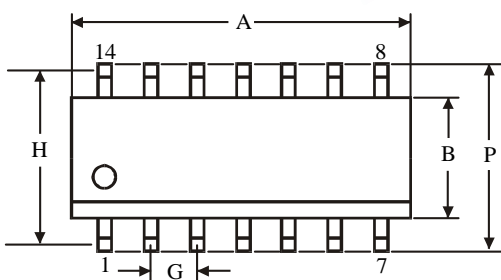

Symbol.	Dimensions, mm	
	MIN	MAX
A	8.55	8.75
B	3.80	4.00
C	1.35	1.75
D	0.33	0.51
F	0.40	1.27
G	1.27	
H	5.72	
J	0°	8°
K	0.10	0.25
M	0.19	0.25
P	5.80	6.20
R	0.25	0.50

**NOTES:**

- Dimensions A and B do not include mold flash or protrusion.
- Maximum mold flash or protrusion 0.15 mm (0.006) per side for A; for B - 0.25 mm (0.010) per side.