

HiPerFET™ Power MOSFETs Q-Class

IXFH 52N30Q
IXFK 52N30Q
IXFT 52N30Q

V_{DSS} = 300 V
I_{D25} = 52 A
R_{DS(on)} = 60 mΩ
t_{rr} ≤ 250 ns

N-Channel Enhancement Mode
Avalanche Rated, High dv/dt, Low t_{rr}
Low Gate Charge and Capacitances

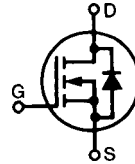

Preliminary data

Symbol	Test Conditions	Maximum Ratings	
V _{DSS}	T _J = 25°C to 150°C	300	V
V _{DGR}	T _J = 25°C to 150°C; R _{GS} = 1 MΩ	300	V
V _{GS}	Continuous	±20	V
V _{GSM}	Transient	±30	V
I _{D25}	T _C = 25°C, Chip capability	52	A
I _{DM}	T _C = 25°C, pulse width limited by T _{JM}	208	A
I _{AR}	T _C = 25°C	52	A
E _{AR}	T _C = 25°C	30	mJ
E _{AS}	T _C = 25°C	1.5	J
dv/dt	I _S ≤ I _{DM} , di/dt ≤ 100 A/μs, V _{DD} ≤ V _{DSS} , T _J ≤ 150°C, R _G = 2 Ω	5	V/ns
P _D	T _C = 25°C	360	W
T _J		-55 ... +150	°C
T _{JM}		150	°C
T _{stg}		-55 ... +150	°C
T _L	1.6 mm (0.063 in) from case for 10 s	300	°C
M _d	Mounting torque	TO-247 TO-264	1.13/10 Nm/lb.in. 0.9/6 Nm/lb.in.
Weight		TO-247 TO-264 TO-268	6 10 4 g

TO-247 AD (IXFH)

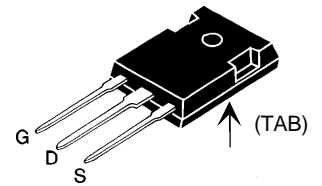

TO-268 (D3) (IXFT)

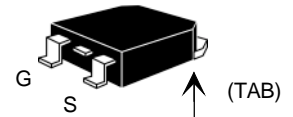

TO-264 AA (IXFK)

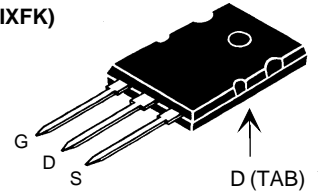

G = Gate
S = Source

TAB = Drain

Features

- Low gate charge
- International standard packages
- Epoxy meet UL94V-0, flammability classification
- Low R_{DS(on)} HDMOS™ process
- Rugged polysilicon gate cell structure
- Avalanche energy and current rated
- Fast intrinsic Rectifier

Advantages

- Easy to mount
- Space savings
- High power density

Symbol	Test Conditions	Characteristic Values (T _J = 25°C, unless otherwise specified)		
		min.	typ.	max.
V _{DSS}	V _{GS} = 0 V, I _D = 1 mA	300		V
V _{GS(th)}	V _{DS} = V _{GS} , I _D = 4 mA	2		V
I _{GSS}	V _{GS} = ±20 V _{DC} , V _{DS} = 0			±200 nA
I _{DSS}	V _{DS} = V _{DSS} , V _{GS} = 0 V			50 μA 1 mA
R _{DS(on)}	V _{GS} = 10 V, I _D = 0.5 • I _{D25} Pulse test, t ≤ 300 μs, duty cycle d ≤ 2 %			60 mΩ

Symbol	Test Conditions	Characteristic Values ($T_j = 25^\circ\text{C}$, unless otherwise specified)		
		min.	typ.	max.
g_{fs}	$V_{DS} = 10\text{ V}; I_D = 0.5 \cdot I_{D25}$, pulse test	22	35	S
C_{iss}	$V_{GS} = 0\text{ V}, V_{DS} = 25\text{ V}, f = 1\text{ MHz}$		5300	pF
C_{oss}			1010	pF
C_{rss}			200	pF
$t_{d(on)}$	$V_{GS} = 10\text{ V}, V_{DS} = 0.5 \cdot V_{DSS}, I_D = 0.5 \cdot I_{D25}$ $R_G = 1.5\ \Omega$ (External),		27	ns
t_r			60	ns
$t_{d(off)}$			80	ns
t_f			25	ns
$Q_{g(on)}$	$V_{GS} = 10\text{ V}, V_{DS} = 0.5 \cdot V_{DSS}, I_D = 0.5 \cdot I_{D25}$		150	nC
Q_{gs}			34	nC
Q_{gd}			75	nC
R_{thJC}			0.35	K/W
R_{thCK}	TO-247		0.25	K/W
	TO-264		0.15	K/W

TO-247 AD (IXFH) Outline

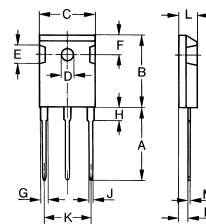

Dim.	Millimeter		Inches	
	Min.	Max.	Min.	Max.
A	19.81	20.32	0.780	0.800
B	20.80	21.46	0.819	0.845
C	15.75	16.26	0.610	0.640
D	3.55	3.65	0.140	0.144
E	4.32	5.49	0.170	0.216
F	5.4	6.2	0.212	0.244
G	1.65	2.13	0.065	0.084
H	-	4.5	-	0.177
J	1.0	1.4	0.040	0.055
K	10.8	11.0	0.426	0.433
L	4.7	5.3	0.185	0.209
M	0.4	0.8	0.016	0.031
N	1.5	2.49	0.087	0.102

TO-264 AA Outline

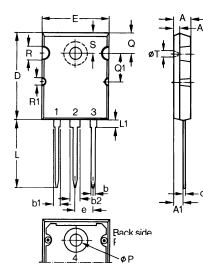

Dim.	Millimeter		Inches	
	Min.	Max.	Min.	Max.
A	4.82	5.13	.190	.202
A1	2.54	2.89	.100	.114
A2	2.00	2.10	.079	.083
b	1.12	1.42	.044	.056
b1	2.39	2.69	.094	.106
b2	2.90	3.09	.114	.122
c	0.53	0.83	.021	.033
D	25.91	26.16	1.020	1.030
E	19.81	19.96	.780	.786
e	5.46	BSC	.215	BSC
J	0.00	0.25	.000	.010
K	0.00	0.25	.000	.010
L	20.32	20.83	.800	.820
L1	2.29	2.59	.090	.102
P	3.17	3.66	.125	.144
Q	6.07	6.27	.239	.247
Q1	8.38	8.69	.330	.342
R	3.81	4.32	.150	.170
R1	1.78	2.29	.070	.090
S	6.04	6.30	.238	.248
T	1.57	1.83	.062	.072

Source-Drain Diode

Symbol	Test Conditions	Characteristic Values ($T_j = 25^\circ\text{C}$, unless otherwise specified)		
		min.	typ.	max.
I_S	$V_{GS} = 0\text{ V}$			52 A
I_{SM}	Repetitive; pulse width limited by T_{JM}			208 A
V_{SD}	$I_F = I_S, V_{GS} = 0\text{ V}$, Pulse test, $t \leq 300\ \mu\text{s}$, duty cycle $d \leq 2\%$			1.5 V
t_{rr}	$I_F = I_S - di/dt = 100\text{ A}/\mu\text{s}, V_R = 100\text{ V}$			250 ns
Q_{RM}			1	μC
I_{RM}			8	A

TO-268AA (D³ PAK)

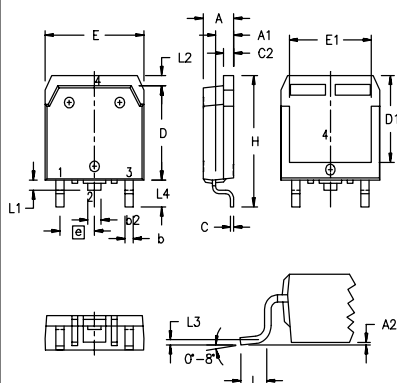

Dim.	Millimeter		Inches	
	Min.	Max.	Min.	Max.
A	4.9	5.1	.193	.201
A ₁	2.7	2.9	.106	.114
A ₂	.02	.25	.001	.010
b	1.15	1.45	.045	.057
b ₂	1.9	2.1	.75	.83
C	.4	.65	.016	.026
D	13.80	14.00	.543	.551
E	15.85	16.05	.624	.632
E ₁	13.3	13.6	.524	.535
e	5.45	BSC	.215	BSC
H	18.70	19.10	.736	.752
L	2.40	2.70	.094	.106
L1	1.20	1.40	.047	.055
L2	1.00	1.15	.039	.045
L3	0.25	BSC	.010	BSC
L4	3.80	4.10	.150	.161

Min. Recommended Footprint

