

HiPerFETs

The HiPerFET family of Power MOSFETs is designed to provide superior dv/dt performance while eliminating the need for discrete, fast recovery "free wheeling" rectifiers in a broad range of power switching applications.

This new class of Power MOSFETs uses IXYS' HDMOS II process which improves the ruggedness of the FET while reducing the reverse recovery time of the intrinsic rectifier to less than 250 ns at elevated (150°C) junction temperature. The performance of the intrinsic rectifier is comparable to discrete high voltage rectifiers and is tailored to minimize power dissipation and stress in the MOSFET

HiPerFETs Offer Extended dv/dt Ruggedness

The HiPerFET series of Power MOSFETs have an extended stress capability in applications where the intrinsic "free-wheeling" diode is used. Both static and commutating dv/dt withstand capability have been improved tenfold to typically 50V/ns and 15V/ns respectively. These devices offer a significant margin of safety in high stress conditions found in many types of inductive power switching applications.

HDMOS II Eliminates Tradeoffs

HDMOS II is a fifth generation power MOS technology developed by IXYS which incorporates the advantages of the original HDMOS process to achieve ultra low $R_{DS(ON)}$, high unclamped energy, and high transconductance. Additionally, HDMOS II includes proprietary lifetime control process to reduce the recovery time (t_{rr}) of the intrinsic rectifier without increasing the on-resistance of the MOSFET. Also contained are enhancements to the MOSFET cell design which significantly improves dv/dt ruggedness.

HiPerFETs Range From 450 to 1000 Volts

IXYS offers the broadest range of MOSFETs with high dv/dt rugged and usable diode characteristics. They are available in ratings of 20 amps at 500 volts and 12 amps at 1000 volts. Even if the application does not require use of the intrinsic rectifier, HiPerFETs offer an extra measure of reliability in harsh industrial circuit environments such as DC motor controls, welders, sonar amplifier and other Hi-Rel/military power conversion systems.

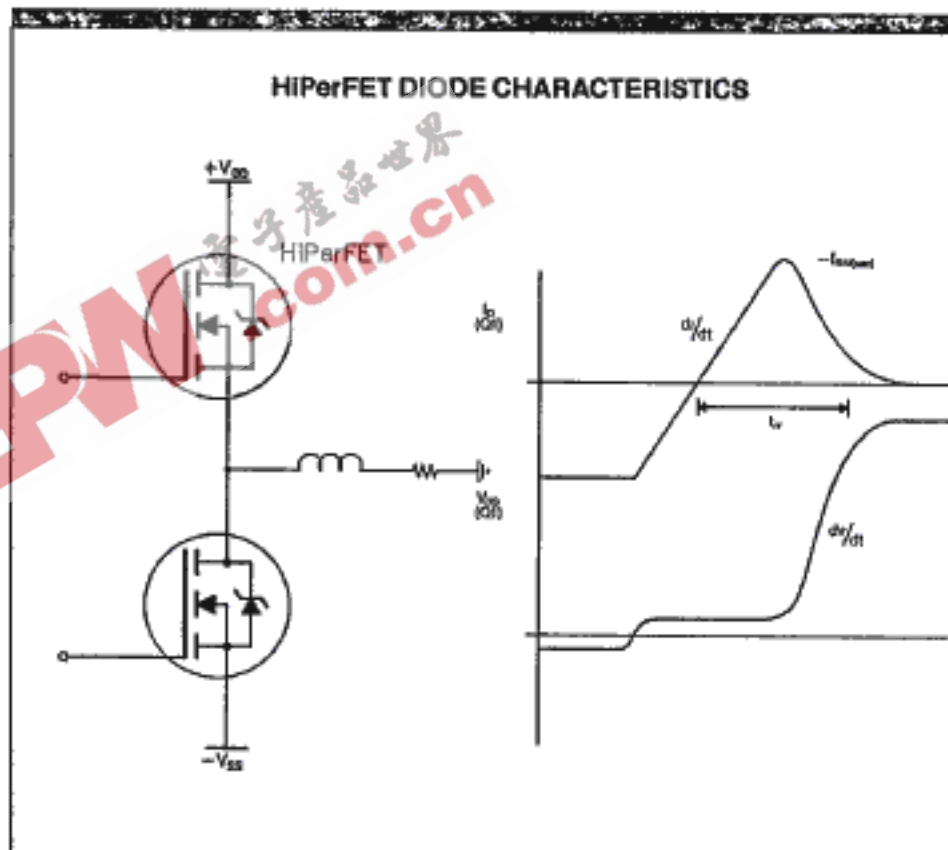



HiPerFET Power MOSFETs

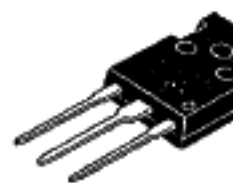

| Part Number | Drain-Source Voltage $V_{DS(ROSS)}$ (Volts) | Drain Current $I_{D(Cont)}$ (Amps) | On Resistance $R_{DS(on)}$ (Ohms) | HiPerFET Characteristics | | | Power Diss. P_D Max (Watts) | Notes | Case Style |
|-------------|---|--|---|------------------------------------|-------------------------------------|----------------------------------|-------------------------------------|-------|------------|
| | | | | Diode Rec Time t_{rr} (nS) | Avalanche Current loss (Amps) | Commutating dv/dt (V/nS) | | | |
| IXFH12N100 | 1000 | 12 | 1.0 | 250 | 12 | 10 | 300 | | TO-247 |
| IXFH11N100 | 1000 | 11 | 1.15 | 250 | 11 | 10 | 300 | | |
| IXFH10N100 | 1000 | 10 | 1.2 | 250 | 10 | 10 | 250 | | |
| IXFH9N100 | 1000 | 9 | 1.4 | 250 | 9 | 10 | 250 | | |
| IXFH6N100 | 1000 | 6 | 2.0 | 250 | 6 | 10 | 150 | | |
| IXFH5N100 | 1000 | 5 | 2.6 | 250 | 5 | 10 | 150 | | |
| IXFH13N90 | 900 | 13 | 0.8 | 250 | 13 | 10 | 300 | | |
| IXFH12N90 | 900 | 12 | 0.9 | 250 | 12 | 10 | 300 | | |
| IXFH11N90 | 900 | 11 | 0.95 | 250 | 11 | 10 | 250 | | |
| IXFH10N90 | 900 | 10 | 1.1 | 250 | 10 | 10 | 250 | | |
| IXFH7N90 | 900 | 7 | 1.5 | 250 | 7 | 10 | 150 | | |
| IXFH6N90 | 900 | 6 | 2.2 | 250 | 6 | 10 | 150 | | |
| IXFH18N65 | 650 | 18 | 0.4 | 250 | 18 | 10 | 300 | | |
| IXFH17N65 | 650 | 17 | 0.45 | 250 | 17 | 10 | 300 | | |
| IXFH15N65 | 650 | 15 | 0.5 | 250 | 15 | 10 | 250 | | |
| IXFH13N65 | 650 | 13 | 0.65 | 250 | 13 | 10 | 250 | | |
| IXFH10N65 | 650 | 10 | 0.7 | 250 | 10 | 10 | 150 | | |
| IXFH8N65 | 650 | 8 | 0.95 | 250 | 8 | 10 | 150 | | |
| IXFH21N60 | 600 | 21 | 0.3 | 250 | 21 | 10 | 300 | | |
| IXFH20N60 | 600 | 20 | 0.35 | 250 | 20 | 10 | 300 | | |
| IXFH17N60 | 600 | 17 | 0.4 | 250 | 17 | 10 | 250 | | |
| IXFH15N60 | 600 | 15 | 0.5 | 250 | 15 | 10 | 250 | | |
| IXFH11N60 | 600 | 11 | 0.55 | 250 | 11 | 10 | 150 | | |
| IXFH10N60 | 600 | 10 | 0.75 | 250 | 10 | 10 | 150 | | |
| IXFH26N50 | 500 | 26 | 0.2 | 250 | 26 | 10 | 300 | | |
| IXFH24N50 | 500 | 24 | 0.23 | 250 | 24 | 10 | 300 | | |
| IXFH21N50 | 500 | 21 | 0.25 | 250 | 21 | 10 | 250 | | |
| IXFH19N50 | 500 | 19 | 0.3 | 250 | 19 | 10 | 250 | | |
| IXFH13N50 | 500 | 13 | 0.4 | 250 | 13 | 10 | 150 | | |
| IXFH12N50 | 500 | 12 | 0.5 | 250 | 12 | 10 | 150 | | |
| IXFH40N30 | 300 | 40 | 0.08 | 250 | 40 | 10 | 250 | | |
| IXFH35N30 | 300 | 35 | 0.1 | 250 | 35 | 10 | 250 | | |
| IXFH50N20 | 200 | 50 | 0.045 | 200 | 50 | 10 | 250 | | |
| IXFH42N20 | 200 | 42 | 0.065 | 200 | 42 | 10 | 250 | | |
| IXFH75N10 | 100 | 75 | 0.02 | 200 | 75 | 10 | 250 | | |
| IXFH67N10 | 100 | 67 | 0.025 | 200 | 67 | 10 | 250 | | |

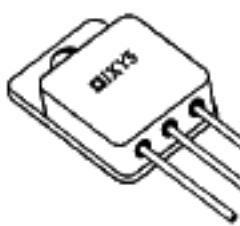

HIPerFET Power MOSFETs

| Part Number | Drain-Source Voltage $V_{DS(ON)}$ (Volts) | Drain Current $I_{D(Cont)}$ (Amps) | On Resistance $R_{DS(on)}$ (Ohms) | HIPerFET Characteristics | | | Power Diss. P_D Max (Watts) | Notes | Case Style |
|-------------|---|------------------------------------|-----------------------------------|------------------------------|-----------------------------------|----------------------------|-------------------------------|---|---|
| | | | | Diode Rec Time t_{rr} (ns) | Avalanche Current I_{AS} (Amps) | Commutating dv/dt (V/ns) | | | |
| IXFL13N65 | 650 | 13 | 0.5 | 250 | 13 | 10 | 175 |  | |
| IXFL9N65 | 650 | 9 | 0.7 | 250 | 9 | 10 | 125 | | |
| IXFL14N60 | 600 | 14 | 0.4 | 250 | 14 | 10 | 175 | | |
| IXFL10N60 | 600 | 10 | 0.55 | 250 | 10 | 10 | 125 | | |
| IXFL18N50 | 500 | 18 | 0.25 | 250 | 18 | 10 | 175 | | |
| IXFL450 | 500 | 12 | 0.4 | 250 | 12 | 10 | 125 | | |
| IXFL24N40 | 400 | 24 | 0.2 | 250 | 24 | 10 | 175 | | |
| IXFL350 | 400 | 14 | 0.3 | 250 | 14 | 10 | 125 | | |
| IXFL25N20 | 200 | 25 | 0.065 | 200 | 25 | 10 | 175 | | |
| IXFL250 | 200 | 25 | 0.1 | 200 | 25 | 10 | 125 | | |
| IXFL25N10 | 100 | 25 | 0.030 | 200 | 25 | 10 | 175 | | |
| IXFL150 | 100 | 25 | 0.065 | 200 | 25 | 10 | 125 | | |
| IXFM12N100 | 1000 | 12 | 1.0 | 250 | 12 | 10 | 300 | |  |
| IXFM11N100 | 1000 | 11 | 1.15 | 250 | 11 | 10 | 300 | | |
| IXFM10N100 | 1000 | 10 | 1.2 | 250 | 10 | 10 | 250 | | |
| IXFM9N100 | 1000 | 9 | 1.4 | 250 | 9 | 10 | 250 | | |
| IXFM8N100 | 1000 | 6 | 2.0 | 250 | 6 | 10 | 150 | | |
| IXFM5N100 | 1000 | 5 | 2.6 | 250 | 5 | 10 | 150 | | |
| IXFM13N90 | 900 | 13 | 0.8 | 250 | 13 | 10 | 300 | | |
| IXFM12N90 | 900 | 12 | 0.9 | 250 | 12 | 10 | 300 | | |
| IXFM11N90 | 900 | 11 | 0.95 | 250 | 11 | 10 | 250 | | |
| IXFM10N90 | 900 | 10 | 1.1 | 250 | 10 | 10 | 250 | | |
| IXFM7N90 | 900 | 7 | 1.5 | 250 | 7 | 10 | 150 | | |
| IXFM6N90 | 900 | 6 | 2.2 | 250 | 6 | 10 | 150 | | |
| IXFM18N65 | 650 | 18 | 0.4 | 250 | 18 | 10 | 300 | | |
| IXFM17N65 | 650 | 17 | 0.45 | 250 | 17 | 10 | 300 | | |
| IXFM15N65 | 650 | 15 | 0.5 | 250 | 15 | 10 | 250 | | |
| IXFM13N65 | 650 | 13 | 0.65 | 250 | 13 | 10 | 250 | | |
| IXFM10N65 | 650 | 10 | 0.7 | 250 | 10 | 10 | 150 | | |
| IXFM9N65 | 650 | 8 | 0.95 | 250 | 8 | 10 | 150 | | |
| IXFM21N60 | 600 | 21 | 0.3 | 250 | 21 | 10 | 300 | | |
| IXFM20N60 | 600 | 20 | 0.35 | 250 | 20 | 10 | 300 | | |
| IXFM17N60 | 600 | 17 | 0.4 | 250 | 17 | 10 | 250 | | |
| IXFM15N60 | 600 | 15 | 0.5 | 250 | 15 | 10 | 250 | | |
| IXFM11N60 | 600 | 11 | 0.55 | 250 | 11 | 10 | 150 | | |
| IXFM10N60 | 600 | 10 | 0.75 | 250 | 10 | 10 | 150 | | |
| IXFM26N50 | 500 | 26 | 0.2 | 250 | 26 | 10 | 300 | | |

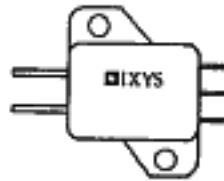
HIPerFET Power MOSFETs

| Part Number | Drain-Source Voltage $V_{DS(ON)}$ (Volts) | Drain Current $I_{D(ON)}$ (Amps) | On Resistance $R_{DS(ON)}$ (Ohms) | HIPerFET Characteristics | | | Power Diss. P_D Max (Watts) | Notes | Case Style |
|-------------|---|----------------------------------|-----------------------------------|---------------------------|-----------------------------------|----------------------------|-------------------------------|---|---|
| | | | | Diode Rec Time t_r (nS) | Avalanche Current I_{AS} (Amps) | Commutating dv/dt (V/nS) | | | |
| IXFM24N50 | 500 | 24 | 0.23 | 250 | 24 | 10 | 300 |  | |
| IXFM21N50 | 500 | 21 | 0.25 | 250 | 21 | 10 | 250 | | |
| IXFM19N50 | 500 | 19 | 0.3 | 250 | 19 | 10 | 250 | | |
| IXFM13N50 | 500 | 13 | 0.4 | 250 | 13 | 10 | 150 | | |
| IXFM12N50 | 500 | 12 | 0.5 | 250 | 12 | 10 | 150 | | |
| IXFM40N30 | 300 | 40 | 0.08 | 250 | 40 | 10 | 250 | | |
| IXFM35N30 | 300 | 35 | 0.1 | 250 | 35 | 10 | 250 | | |
| IXFM50N20 | 200 | 50 | 0.045 | 200 | 50 | 10 | 250 | | |
| IXFM42N20 | 200 | 42 | 0.065 | 200 | 42 | 10 | 250 | | |
| IXFM75N10 | 100 | 75 | 0.02 | 200 | 75 | 10 | 250 | | |
| IXFM67N10 | 100 | 67 | 0.025 | 200 | 67 | 10 | 250 | | |
| IXFZ11N100 | 1000 | 11 | 1.15 | 250 | 11 | 10 | 300 |  | |
| IXFZ12N90 | 900 | 12 | 0.9 | 250 | 12 | 10 | 300 | | |
| IXFZ18N65 | 650 | 18 | 0.4 | 250 | 18 | 10 | 300 | | |
| IXFZ21N60 | 600 | 21 | 0.3 | 250 | 21 | 10 | 300 | | |
| IXFZ24N50 | 500 | 24 | 0.23 | 250 | 24 | 10 | 300 | | |
| IXFZ35N30 | 300 | 35 | 0.1 | 250 | 35 | 10 | 250 | | |
| IXFZ42N20 | 200 | 42 | 0.065 | 200 | 42 | 10 | 250 | | |
| IXFZ67N10 | 100 | 67 | 0.025 | 200 | 67 | 10 | 250 | | |
| IXFN15N100 | 1000 | 15 | 0.6 | 250 | --- | 10 | 325 | 1 |  |
| IXFN17N80 | 800 | 17 | 0.5 | 250 | --- | 10 | 325 | 1 | |
| IXFN35N50 | 500 | 35 | 0.12 | 250 | 35 | 10 | 325 | 1 | |
| IXFN50N25 | 250 | 50 | 0.05 | 250 | 50 | 10 | 300 | 1 | |
| IXFN64N20 | 200 | 64 | 0.033 | 250 | 64 | 10 | 300 | | |
| IXFN100N10 | 100 | 100 | 0.013 | 250 | 100 | 10 | 300 | | |

Notes: 1. Available 4Q89

DETAILED PACKAGE OUTLINES

T-91-20

TO-220 AB

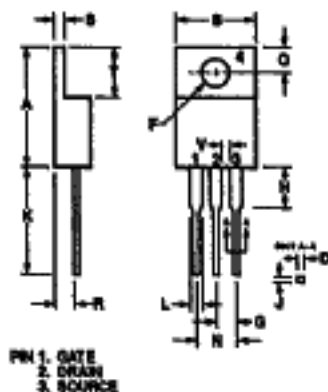

PIN 1. GATE
2. DRAIN
3. SOURCE

| Dim. | Millimeter | | Inches | |
|------|------------|-------|--------|------|
| | Min. | Max. | Min. | Max. |
| A | 14.23 | 16.51 | .560 | .650 |
| B | 9.65 | 10.65 | .380 | .420 |
| C | 3.56 | 4.82 | .140 | .190 |
| D | 0.64 | 0.89 | .025 | .035 |
| F | 3.54 | 4.00 | .139 | .161 |
| G | 2.29 | 2.79 | .090 | .110 |
| H | - | 6.35 | - | .250 |
| J | 0.51 | .76 | .020 | .030 |
| K | 12.79 | 14.73 | .500 | .580 |
| L | 1.15 | 1.77 | .045 | .070 |
| N | 4.83 | 5.33 | .190 | .210 |
| Q | 2.54 | 3.42 | .100 | .135 |
| R | 2.64 | 2.49 | .060 | .115 |
| S | 0.64 | 1.39 | .025 | .055 |
| T | 5.85 | 6.85 | .230 | .270 |
| V | 1.15 | - | .045 | - |

CONFORMS TO OUTLINE TO-220 (IR H-7)
Dimensions in Millimeters (Inches)

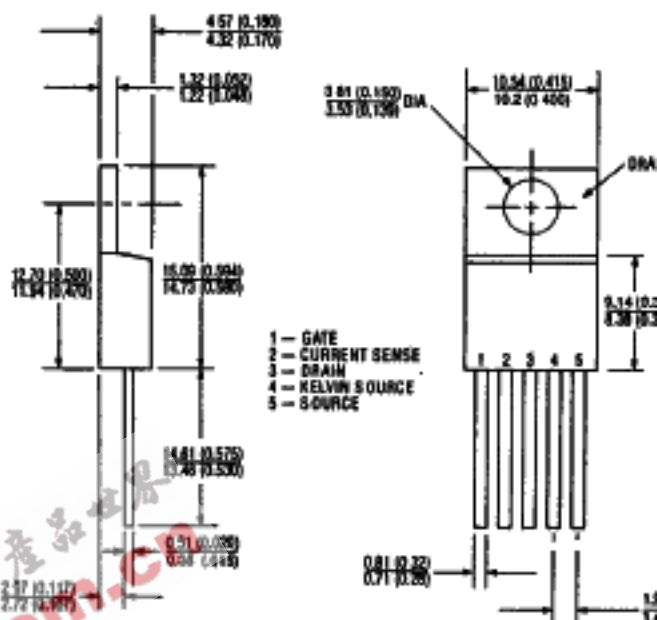

TO-247 (3 LEADED)

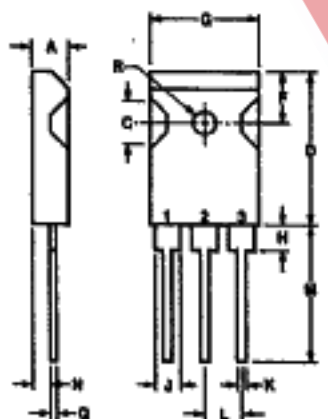

PIN 1. GATE
2. DRAIN
3. SOURCE

| Dim. | Millimeter | | Inches | |
|----------------|------------|------|--------|------|
| | Min. | Max. | Min. | Max. |
| A | 4.7 | 5.3 | .185 | .209 |
| C | 4.5 | 6.0 | .178 | .236 |
| D | 19.7 | 21.4 | .776 | .843 |
| F | 5.3 | 6.1 | .209 | .240 |
| G | 15.3 | 15.9 | .602 | .625 |
| H | 3.7 | 4.3 | .146 | .169 |
| J | 1.95 | 2.4 | .077 | .094 |
| J ₁ | 2.97 | 3.4 | .117 | .134 |
| K | 1.0 | 1.4 | .040 | .055 |
| L | 5.4 | 5.5 | .213 | .217 |
| M | 19.9 | 20.2 | .783 | .795 |
| N | 2.2 | 2.6 | .087 | .102 |
| Q | 0.4 | 0.8 | .016 | .031 |
| R | 2.9 | 3.3 | .114 | .129 |

TO-247 (5 LEADED)

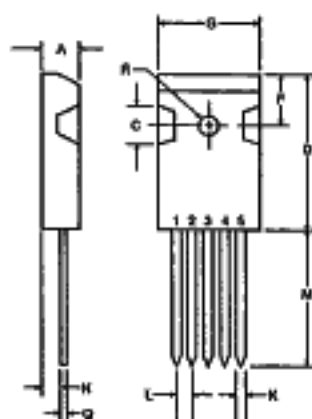

PIN 1. GATE
2. MIRROR
3. DRAIN
4. KELVIN
5. SOURCE

| Dim. | Millimeter | | Inches | |
|------|------------|------|--------|------|
| | Min. | Max. | Min. | Max. |
| A | 4.7 | 5.3 | .185 | .209 |
| C | 4.5 | 6.0 | .178 | .236 |
| D | 19.7 | 21.4 | .776 | .843 |
| F | 5.3 | 6.1 | .209 | .240 |
| G | 15.3 | 15.9 | .602 | .625 |
| K | 1.1 | 1.3 | .043 | .051 |
| L | 2.61 | 2.58 | .099 | .101 |
| M | 19.9 | 20.2 | .783 | .795 |
| N | 2.2 | 2.6 | .087 | .102 |
| Q | 0.4 | 0.8 | .016 | .031 |
| R | 2.9 | 3.3 | .114 | .129 |

TO-238
Dimensions in Millimeters

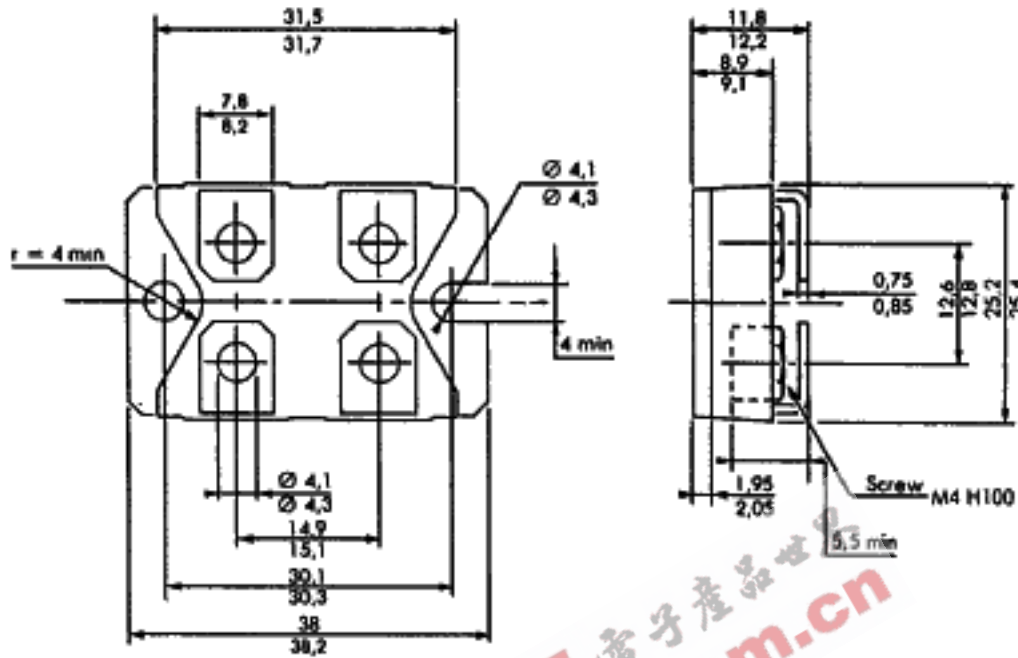

Y-4
Dimensions in Millimeters

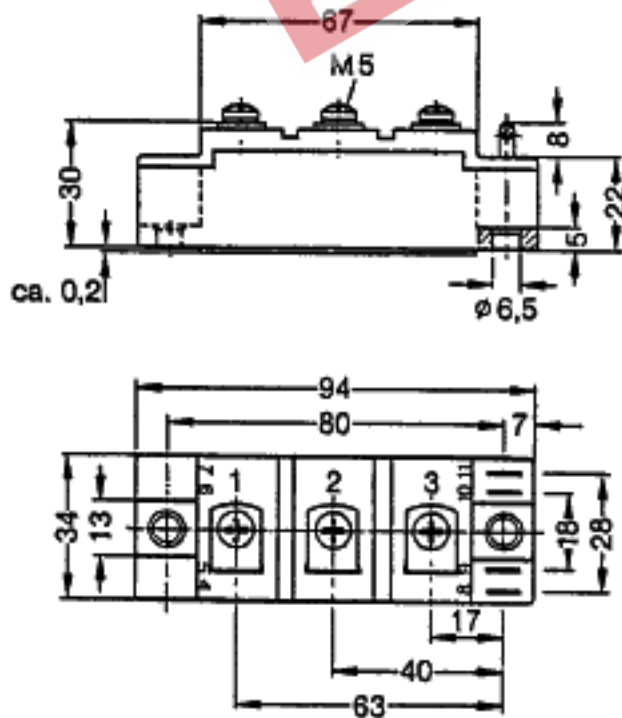

Y-3
Dimensions in Millimeters

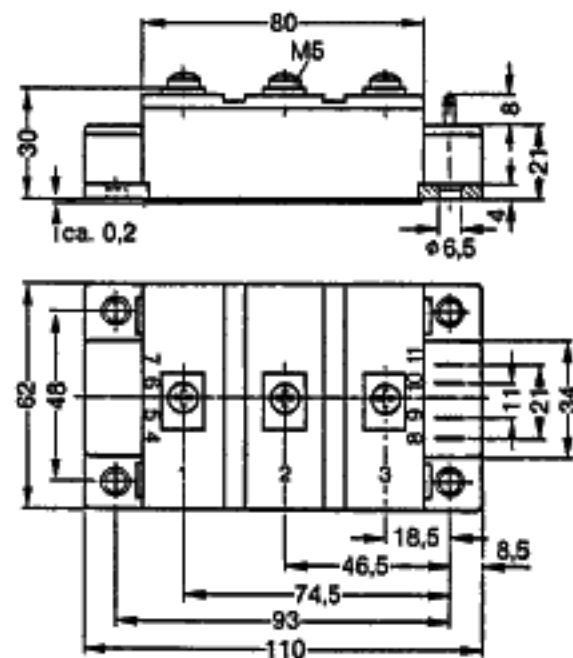

CONFORMS TO JEDEC OUTLINE TO-210AC (TO-61)
 Dimensions in Millimeters (Inches)

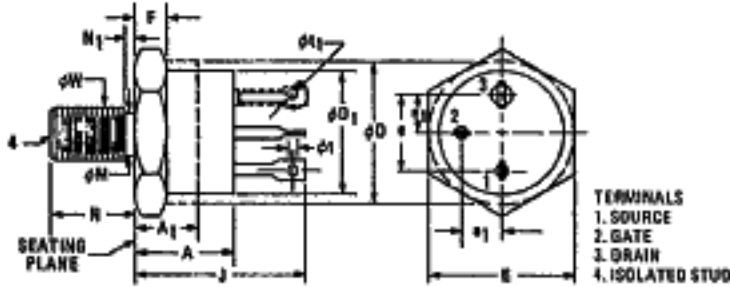

TERMINALS
 1. SOURCE
 2. GATE
 3. DRAIN
 4. ISOLATED STUD

| Symbol | Inches | | Millimeters | | Notes |
|--------------------|--------|-------|-------------|-------|-------|
| | Min. | Max. | Min. | Max. | |
| A | 0.325 | 0.400 | 8.26 | 11.68 | |
| A ₁ | 0.270 | 0.300 | 6.86 | 7.62 | 2 |
| phi D | 0.670 | 0.687 | 16.91 | 17.45 | 2 |
| phi D ₁ | 0.570 | 0.610 | 14.48 | 15.40 | |
| e | 0.060 | 0.087 | 1.51 | 2.21 | |
| phi | 0.340 | 0.415 | 8.64 | 10.54 | 5 |
| phi 1 | 0.170 | 0.213 | 4.32 | 5.41 | 5 |
| F | 0.050 | 0.100 | 1.27 | 2.54 | 1 |

| Symbol | Inches | | Millimeters | | Notes |
|--------------------|--------|--------|-------------|-------|-------|
| | Min. | Max. | Min. | Max. | |
| J | 0.540 | 0.675 | 13.76 | 17.16 | |
| phi M | 0.720 | 0.748 | 18.29 | 19.01 | |
| N | 0.422 | 0.456 | 10.72 | 11.56 | |
| N ₁ | 0.055 | 0.070 | 1.39 | 1.78 | |
| phi 1 | 0.065 | 0.072 | 1.65 | 1.83 | |
| phi 1 ₁ | 0.046 | 0.077 | 1.17 | 1.96 | 4 |
| phi W | 0.2225 | 0.2704 | 5.661 | 6.901 | 3 |

NOTES

1. DIMENSION DOES NOT INCLUDE SEALING FLANGES.
2. PACKAGE CONTOUR OPTIONAL WITHIN DIMENSIONS SPECIFIED.
3. PITCH DIAMETER - THREAD 1/4-28 UNF 2A COATED. REFERENCE ISCREM THREAD STANDARDS FOR FEDERAL SERVICES - HANDBOOK H-201.
4. THIS TERMINAL CAN BE FLATTENED AND PIERCED OR HOOK TYPE.
5. POSITION OF LEADS IN RELATION TO THE HEXAGON IS NOT CONTROLLED.

QUADPAC

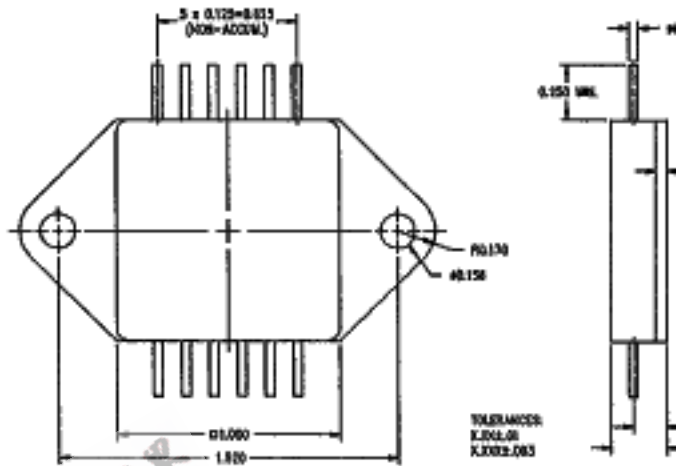

TOLERANCES:
 X.XXX±.01
 X.XXX±.005

Z-Pac



TOLERANCES:
 X.XXX±.01
 X.XXX±.005

