

Low Power RTC with V_{DD} Battery Backed SRAM and Embedded Temp Compensation $\pm 5\text{ppm}$ with Auto Day Light Saving

The ISL12020 device is a low power real time clock with an embedded Temp sensor for oscillator compensation, clock/calendar, power fail, low battery monitor, brown out indicator, single periodic or polled alarms, intelligent battery backup switching and 128 bytes of battery-backed user SRAM.

The oscillator uses an external, low-cost 32.768kHz crystal. The real time clock tracks time with separate registers for hours, minutes, and seconds. The device has calendar registers for date, month, year and day of the week. The calendar is accurate through 2099, with automatic leap year correction.

Daylight Savings time adjustment is done automatically, using parameters entered by the user. Power fail and battery monitors offer user-selectable trip levels. A time stamp function records the time and date of switchover from V_{DD} to battery power, and also from battery to V_{DD} power.

Pinout

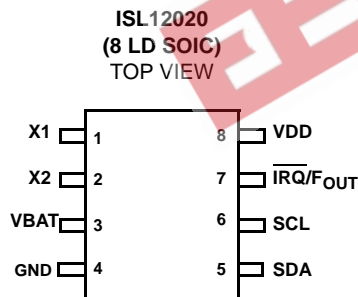

Features

- Real Time Clock/Calendar
 - Tracks Time in Hours, Minutes and Seconds
 - Day of the Week, Day, Month and Year
- On-chip Oscillator Compensation Over the Operating Temp Range
 - $\pm 5\text{ppm}$ over -20°C to $+70^{\circ}\text{C}$
- Day Light Saving Time
 - Customer Programmable
- 15 Selectable Frequency Outputs
- 1 Alarm
 - Settable to the Second, Minute, Hour, Day of the Week, Day, or Month
 - Single Event or Pulse Interrupt Mode
- Automatic Backup to Battery or Super Cap
 - Operation to $V_{\text{BAT}} = 1.8\text{V}$
 - $1.0\mu\text{A}$ Battery Supply Current
- Battery Status Monitor, 2 Levels, Selectable by Customer to:
 - Seven Selectable Voltages for Each Level
- Power Status Brown Out Monitor
- Six Selectable Trip Level, from 4.675V to 2.295V Power Failure Detection
- Time Stamp during Power to Battery and Battery to Power Cross Over
 - Time Stamp. First V_{DD} to V_{BAT} , and Last V_{BAT} to V_{DD}
- 128 Bytes Battery-Backed User SRAM
- I²C Interface
 - 400kHz Clock Frequency
- 8 Ld SOIC Package ISL12020
- Pb-Free Plus Anneal Available (RoHS Compliant)

Applications

- Utility Meters
- POS Equipment
- Medical Application
- Security Related Application
- Vending Machine
- White Goods

ISL12020

Ordering Information

PART NUMBER (Note)	PART MARKING	V _{DD} RANGE	TEMP RANGE (°C)	PACKAGE (Pb-free)	PKG DWG #
Future Product ISL12020IBZ*	12020 IBZ	2.7V to 5.5V	-40 to +85	8 Ld SOIC	M8.15
ISL12020CBZ*	12020 CBZ	2.7V to 5.5V	-20 to +70	8 Ld SOIC	M8.15

*Add "-T" suffix for tape and reel.

NOTE: Intersil Pb-free plus anneal products employ special Pb-free material sets; molding compounds/die attach materials and 100% matte tin plate termination finish, which are RoHS compliant and compatible with both SnPb and Pb-free soldering operations. Intersil Pb-free products are MSL classified at Pb-free peak reflow temperatures that meet or exceed the Pb-free requirements of IPC/JEDEC J STD-020.

Block Diagram

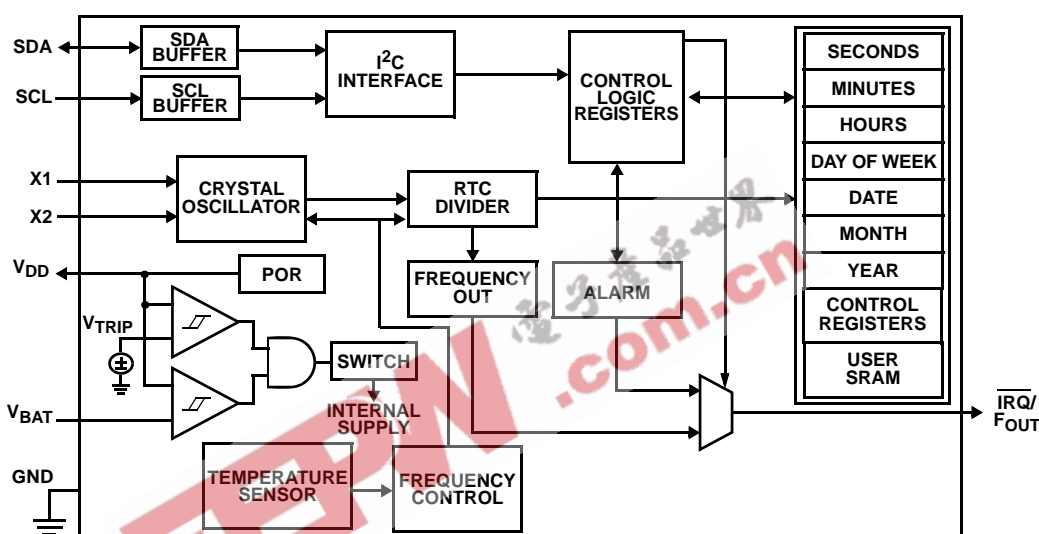

Pin Descriptions

PIN NUMBER	SYMBOL	DESCRIPTION
1	X1	X1. The X1 pin is the input of an inverting amplifier and is intended to be connected to one pin of an external 32.768kHz quartz crystal. X1 can also be driven directly from a 32.768kHz source.
2	X2	X2. The X2 pin is the output of an inverting amplifier and is intended to be connected to one pin of an external 32.768kHz quartz crystal. X2 should be left open when X1 is driven from external source.
3	VBAT	VBAT. This input provides a backup supply voltage to the device. V _{BAT} supplies power to the device in the event that the V _{DD} supply fails. This pin should be tied to ground if not used.
4	GND	Ground.
5	SDA	Serial Data (SDA). SDA is a bi-directional pin used to transfer serial data into and out of the device. It has an open drain output and may be wire OR'ed with other open drain or open collector outputs.
6	SCL	Serial Clock (SCL). The SCL input is used to clock all serial data into and out of the device.
7	$\overline{\text{IRQ}}$ /FOUT	Interrupt Output $\overline{\text{IRQ}}$, /Frequency Output FOUT. Multi-functional pin that can be used as interrupt or frequency output pin. The function is set via the configuration register.
8	VDD	VDD. Power supply.

ISL12020

Absolute Maximum Ratings

Voltage on VDD, VBAT, SCL, SDA, and $\overline{\text{IRQ}}/\text{F}_{\text{OUT}}$ pins (respect to ground)	-0.3V to 6.0V
Voltage on X1 and X2 pins (respect to ground)	-0.3V to 2.5V
ESD Rating	
Human Body Model (Per MIL-STD-883 Method 3014)	>2kV
Machine Model	>150V

Thermal Information

Thermal Resistance (Typical, Note 1)	θ_{JA} (°C/W)
8 Ld SOIC	120
Storage Temperature	-65°C to +150°C
Lead Temperature (Soldering, 10s)	+300°C
Pb-free reflow profile	see link below http://www.intersil.com/pbfree/Pb-FreeReflow.asp

CAUTION: Stresses above those listed in "Absolute Maximum Ratings" may cause permanent damage to the device. This is a stress only rating and operation of the device at these or any other conditions above those indicated in the operational sections of this specification is not implied.

NOTE:

1. θ_{JA} is measured with the component mounted on a high effective thermal conductivity test board in free air. See Tech Brief TB379 for details.

DC Operating Characteristics-RTC Test Conditions: $V_{\text{DD}} = +2.7$ to $+5.5\text{V}$, Temperature = -20°C to $+70^\circ\text{C}$, unless otherwise stated.

SYMBOL	PARAMETER	CONDITIONS	MIN	TYP (Note 7)	MAX	UNITS	NOTES
V_{DD}	Main Power Supply		2.7		5.5	V	
V_{BAT}	Battery Supply Voltage		1.8		5.5	V	2
I_{DD1}	Supply Current	$V_{\text{DD}} = 5\text{V}$		4.1	6.5	μA	3, 5
		$V_{\text{DD}} = 3\text{V}$		3.5	5.5	μA	3, 5
I_{DD2}	Supply Current ($I^2\text{C}$ communications active)	$V_{\text{DD}} = 5\text{V}$		300	500	μA	3, 4
I_{DD3}	Supply Current (Temperature Conversion Active)	$V_{\text{DD}} = 5\text{V}$		250	400	μA	3, 4
I_{BAT}	Battery Supply Current	$V_{\text{BAT}} = 3\text{V} @ +25^\circ\text{C}$		1.0	1.6	μA	3
		$V_{\text{BAT}} = 3\text{V}$		1.0	2.1	μA	3
I_{BATLKG}	Battery Input Leakage	$V_{\text{DD}} = 5.5\text{V}, V_{\text{BAT}} = 1.8\text{V}$			100	nA	
I_{LI}	Input Leakage Current on SCL			100		nA	4
I_{LO}	I/O Leakage Current on SDA			100		nA	4
V_{BATM}	Battery Level Monitor Threshold		-100		+100	mV	
V_{PBM}	Brown Out Level Monitor Threshold		-100		+100	mV	
V_{TRIP}	V_{BAT} Mode Threshold		2.1	2.2	2.6	V	
V_{TRIPHYS}	V_{TRIP} Hysteresis		10	30	50	mV	
V_{BATHYS}	V_{BAT} Hysteresis			50		mV	9
	Frequency Stability vs Temperature	$2.7\text{V} \leq V_{\text{DD}} \leq 3.6\text{V}$,		± 5		ppm	9
	Frequency Stability vs Voltage	$2.7\text{V} \leq V_{\text{DD}} \leq 3.6\text{V}$		± 3		ppm	9
	ATR Sensitivity per LSB	BETA (3:0) = 1000		1		ppm	9
	Temperature Sensor Accuracy	$V_{\text{DD}} = V_{\text{BAT}} = 3.3\text{V}$		± 3		$^\circ\text{C}$	9
$\overline{\text{IRQ}}/\text{F}_{\text{OUT}}$							
V_{OL}	Output Low Voltage	$V_{\text{DD}} = 5\text{V}, I_{\text{OL}} = 3\text{mA}$			0.4	V	
		$V_{\text{DD}} = 2.7\text{V}, I_{\text{OL}} = 1\text{mA}$			0.4	V	

Power-Down Timing Test Conditions: $V_{\text{DD}} = +2.7$ to $+5.5\text{V}$, Temperature = -20°C to $+70^\circ\text{C}$, unless otherwise stated.

SYMBOL	PARAMETER	CONDITIONS	MIN	TYP (Note 7)	MAX	UNITS	NOTES
$V_{\text{DD SR-}}$	V_{DD} Negative Slew rate				10	V/ms	8

ISL12020

I²C Interface Specifications Test Conditions: V_{DD}=+2.7 to +5.5V, Temperature = -20°C to +70°C, unless otherwise specified.

SYMBOL	PARAMETER	TEST CONDITIONS	MIN	TYP (Note 7)	MAX	UNITS	NOTES
V _{IL}	SDA and SCL input buffer LOW voltage		-0.3		0.3 x V _{DD}	V	
V _{IH}	SDA and SCL Input Buffer HIGH Voltage		0.7 x V _{DD}		V _{DD} + 0.3	V	
Hysteresis	SDA and SCL Input Buffer Hysteresis		0.05 x V _{DD}			V	
V _{OL}	SDA Output Buffer LOW Voltage, Sinking 3mA	V _{DD} = 5V, I _{OL} = 3mA			0.4	V	
C _{PIN}	SDA and SCL Pin Capacitance	T _A = +25°C, f = 1MHz, V _{DD} = 5V, V _{IN} = 0V, V _{OUT} = 0V			10	pF	
f _{SCL}	SCL Frequency				400	kHz	
t _{IN}	Pulse Width Suppression Time at SDA and SCL Inputs	Any pulse narrower than the max spec is suppressed.			50	ns	
t _{AA}	SCL Falling Edge To SDA Output Data Valid	SCL falling edge crossing 30% of V _{DD} , until SDA exits the 30% to 70% of V _{DD} window.			900	ns	
t _{BUF}	Time the Bus Must be Free Before The Start of a New Transmission	SDA crossing 70% of V _{DD} during a STOP condition, to SDA crossing 70% of V _{DD} during the following START condition.	1300			ns	
t _{LOW}	Clock LOW Time	Measured at the 30% of V _{DD} crossing.	1300			ns	
t _{HIGH}	Clock HIGH Time	Measured at the 70% of V _{DD} crossing.	600			ns	
t _{SU:STA}	START Condition Setup Time	SCL rising edge to SDA falling edge. Both crossing 70% of V _{DD} .	600			ns	
t _{HD:STA}	START Condition Hold Time	From SDA falling edge crossing 30% of V _{DD} to SCL falling edge crossing 70% of V _{DD} .	600			ns	
t _{SU:DAT}	Input Data Setup Time	From SDA exiting the 30% to 70% of V _{DD} window, to SCL rising edge crossing 30% of V _{DD} .	100			ns	
t _{HD:DAT}	Input Data Hold Time	From SCL falling edge crossing 30% of V _{DD} to SDA entering the 30% to 70% of V _{DD} window.	0		900	ns	
t _{SU:STO}	STOP Condition Setup Time	From SCL rising edge crossing 70% of V _{DD} , to SDA rising edge crossing 30% of V _{DD} .	600			ns	
t _{HD:STO}	STOP Condition Hold Time	From SDA rising edge to SCL falling edge. Both crossing 70% of V _{DD} .	600			ns	

ISL12020

I²C Interface Specifications Test Conditions: V_{DD}=+2.7 to +5.5V, Temperature = -20°C to +70°C, unless otherwise specified. (Continued)

SYMBOL	PARAMETER	TEST CONDITIONS	MIN	TYP (Note 7)	MAX	UNITS	NOTES
t _{DH}	Output Data Hold Time	From SCL falling edge crossing 30% of V _{DD} , until SDA enters the 30% to 70% of V _{DD} window.	0			ns	
t _R	SDA and SCL Rise Time	From 30% to 70% of V _{DD} .	20 + 0.1 x C _b		300	ns	
t _F	SDA and SCL Fall Time	From 70% to 30% of V _{DD} .	20 + 0.1 x C _b		300	ns	
C _b	Capacitive loading of SDA or SCL	Total on-chip and off-chip	10		400	pF	
R _{PU}	SDA and SCL Bus Pull-up Resistor Off-chip	Maximum is determined by t _R and t _F . For C _b = 400pF, max is about 2~2.5kΩ. For C _b = 40pF, max is about 15~20kΩ	1			kΩ	

NOTES:

2. Temperature Conversion is inactive below 2.7V V_{BAT}
3. \overline{IRQ}/F_{OUT} Inactive.
4. V_{IL} = V_{DD} x 0.1, V_{IH} = V_{DD} x 0.9, f_{SCL} = 400kHz
5. V_{DD} > V_{BAT} + V_{BATHYS}
6. Bit BSW = 0 (Standard Mode), V_{BAT} ≥ 1.8V
7. Specified at +25°C.
8. In order to ensure proper timekeeping, the V_{DD} SR- specification must be followed.
9. Parameter is not 100% tested.
10. These are I²C specific parameters and are not tested, however, they are used to set conditions for testing devices to validate specification.

SDA vs SCL Timing

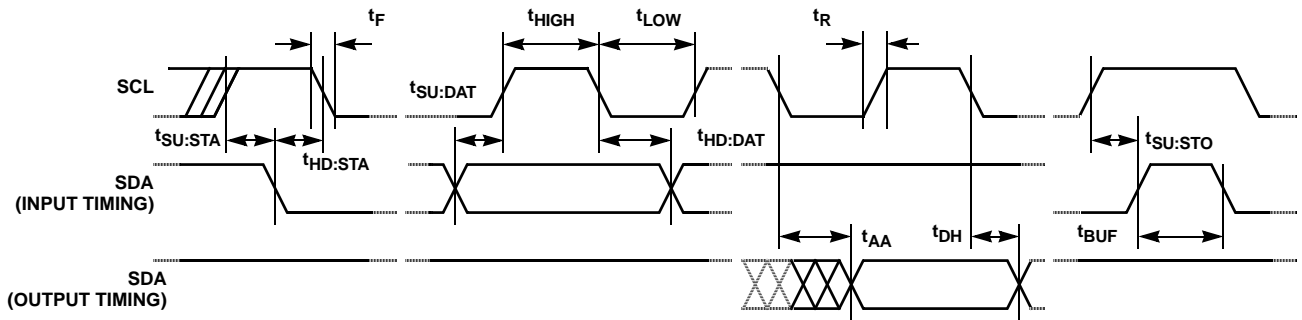

Symbol Table

WAVEFORM	INPUTS	OUTPUTS
	Must be steady	Will be steady
	May change from LOW to HIGH	Will change from LOW to HIGH
	May change from HIGH to LOW	Will change from HIGH to LOW
	Don't Care: Changes Allowed	Changing: State Not Known
	N/A	Center Line is High Impedance

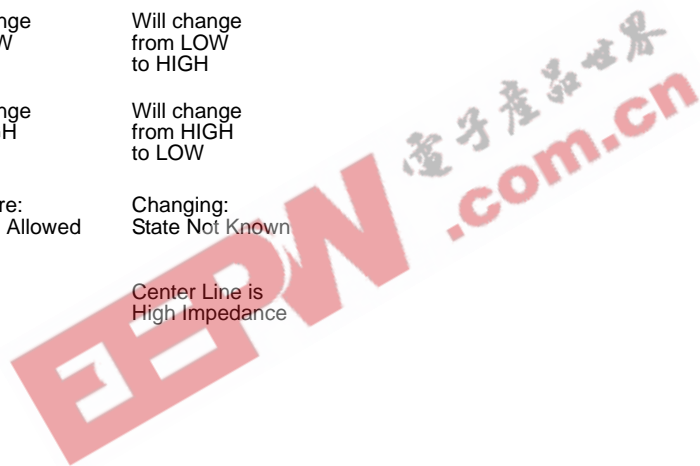

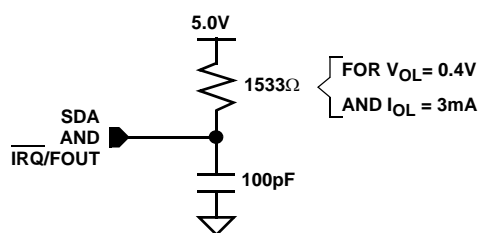
EQUIVALENT AC OUTPUT LOAD CIRCUIT FOR $V_{DD} = 5V$ FIGURE 1. STANDARD OUTPUT LOAD FOR TESTING THE DEVICE WITH $V_{DD} = 5.0V$

General Description

The ISL12020 devices are low power real time clocks (RTCs) with embedded temperature sensors. They contain crystal frequency compensation circuitry over the operating temperature range, clock/calendar, power fail and low battery monitors, brown out indicator with separate ($\overline{\text{LVRSET}}$) reset pin (ISL12021 only), 1 periodic or polled alarm, intelligent battery backup switching and 128 Bytes of battery-backed user SRAM.

The oscillator uses an external, low cost 32.768kHz crystal. The real time clock tracks time with separate registers for hours, minutes and seconds. The device has calendar registers for date, month, year and day of the week. The calendar is accurate through 2099, with automatic leap year correction. In addition, both the ISL12020 could be programmed for automatic Daylight Saving Time (DST) adjustment by entering local DST information.

The ISL1202x's alarm can be set to any clock/calendar value for a match. For example, every minute, every Tuesday or at 5:23 AM on March 21. The alarm status is available by checking the Status Register, or the device can be configured to provide a hardware interrupt via the IRQ pin. There is a repeat mode for the alarm allowing a periodic interrupt every minute, every hour, every day, etc.

The device also offers a backup power input pin. This V_{BAT} pin allows the device to be backed up by battery or Super Cap with automatic switchover from V_{DD} to V_{BAT} . The ISL12020 devices are specified for $V_{DD} = 2.7V$ to $5.5V$ and the clock/calendar portion of the device remains fully operational in battery backup mode down to $1.8V$ (Standby Mode). The V_{BAT} level is monitored and reported against preselected levels. The first report is registered when the V_{BAT} level falls below 85% of nominal level, the second level is set for 75%. Battery levels are stored in V_{BATM} registers.

The ISL12020 offers a "Brown Out" alarm once the V_{DD} falls below a pre-selected trip level. In the ISL12020, this allows system Micro to save vital information to memory before complete power loss. There are six V_{DD} levels that could be selected for initiation of brown out alarm.

Pin Descriptions

X1, X2

The X1 and X2 pins are the input and output, respectively, of an inverting amplifier. An external 32.768kHz quartz crystal is used with the device to supply a timebase for the real time clock. Internal compensation circuitry with internal temperature sensor provides frequency corrections for selected popular crystals to $\pm 5\text{ppm}$ over the operating temperature range from -40°C to $+85^{\circ}\text{C}$. (See "Application Section" on page 22 for recommended crystal). ISL12020 allows the user to input via I2C serial bus the temperature variation profile of crystals not listed in the "Application Section" on page 22. This oscillator compensation network can also be used to calibrate the initial crystal timing accuracy at room temperature. The device can also be driven directly from a 32.768kHz source at pin X1.

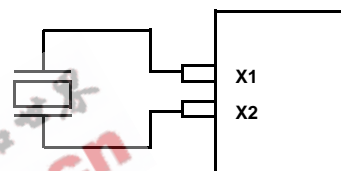

FIGURE 2. RECOMMENDED CRYSTAL CONNECTION

V_{BAT}

This input provides a backup supply voltage to the device. V_{BAT} supplies power to the device in the event that the V_{DD} supply fails. This pin can be connected to a battery, a Super Capacitor or tied to ground if not used. See the Battery Monitor parameter in the *DC Operating Characteristics-RTC* on page 3.

$\overline{\text{IRQ}}/\text{FOUT}$ (Interrupt Output/Frequency Output)

This dual function pin can be used as an interrupt or frequency output pin. The $\overline{\text{IRQ}}/\text{FOUT}$ mode is selected via the frequency out control bits of the control/status register.

- **Interrupt Mode.** The pin provides an interrupt signal output. This signal notifies a host processor that an alarm has occurred and requests action. It is an open drain active low output.
- **Frequency Output Mode.** The pin outputs a clock signal which is related to the crystal frequency. The frequency output is user selectable and enabled via the I²C bus. It is an open drain output.

Serial Clock (SCL)

The SCL input is used to clock all serial data into and out of the device. The input buffer on this pin is always active (not gated). It is disabled when the backup power supply on the V_{BAT} pin is activated to minimize power consumption.

Serial Data (SDA)

SDA is a bi-directional pin used to transfer data into and out of the device. It has an open drain output and may be ORED with other open drain or open collector outputs. The input buffer is always active (not gated) in normal mode.

An open drain output requires the use of a pull-up resistor. The output circuitry controls the fall time of the output signal with the use of a slope controlled pull-down. The circuit is designed for 400kHz I²C interface speeds. It is disabled when the backup power supply on the V_{BAT} pin is activated.

VDD, GND

Chip power supply and ground pins. The device will operate with a power supply from V_{DD} = 2.7V to 5.5VDC. A 0.1μF capacitor is recommended on the V_{DD} pin to ground.

Functional Description

Power Control Operation

The power control circuit accepts a V_{DD} and a V_{BAT} input. Many types of batteries can be used with Intersil RTC products. For example, 3.0V or 3.6V Lithium batteries are appropriate, and battery sizes are available that can power the ISL1202x for up to 10 years. Another option is to use a Super Capacitor for applications where V_{DD} is interrupted for up to a month. See the "Application Section" on page 22 for more information.

Normal Mode (V_{DD}) to Battery Backup Mode (V_{BAT})

To transition from the V_{DD} to V_{BAT} mode, both of the following conditions must be met:

Condition 1:

$V_{DD} < V_{BAT} - V_{BATHYS}$
where $V_{BATHYS} \approx 50\text{mV}$

Condition 2:

$V_{DD} < V_{TRIP}$
where $V_{TRIP} \approx 2.2\text{V}$

Battery Backup Mode (V_{BAT}) to Normal Mode (V_{DD})

The ISL12020 device will switch from the V_{BAT} to V_{DD} mode when one of the following conditions occurs:

Condition 1:

$V_{DD} > V_{BAT} + V_{BATHYS}$
where $V_{BATHYS} \approx 50\text{mV}$

Condition 2:

$V_{DD} > V_{TRIP} + V_{TRIPHYS}$
where $V_{TRIPHYS} \approx 30\text{mV}$

These power control situations are illustrated in Figure 3 and Figure 4.

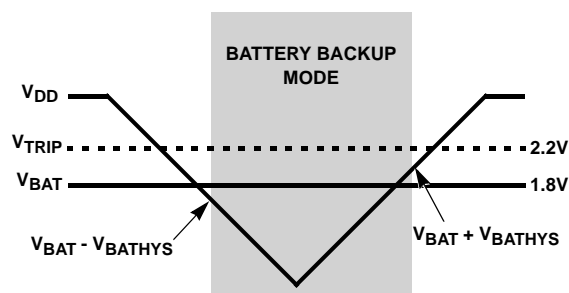

FIGURE 3. BATTERY SWITCHOVER WHEN $V_{BAT} < V_{TRIP}$

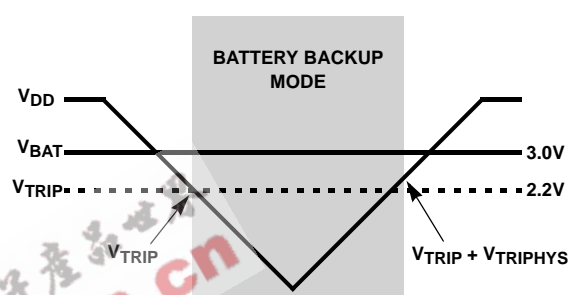

FIGURE 4. BATTERY SWITCHOVER WHEN $V_{BAT} > V_{TRIP}$

The I²C bus is deactivated in battery backup mode to reduce power consumption. Aside from this, all RTC functions are operational during battery backup mode. Except for SCL and SDA, all the inputs and outputs of the ISL12020 are active during battery backup mode unless disabled via the control register.

The device Time Stamps the switchover from V_{DD} to V_{BAT} and V_{BAT} to V_{DD}, and the time is stored in T_{SV2B} and T_{SB2V} registers respectively. If multiple V_{DD} power down sequences occur before status is read, the earliest V_{DD} to V_{BAT} power down time is stored and the most recent V_{BAT} to V_{DD} time is stored.

Temperature conversion and compensation can be enabled in battery backup mode. Bit BTSE in the BETA register controls this operation as described in that register section.

Power Failure Detection

Both the ISL12020 provide a Real Time Clock Failure Bit (RTCF) to detect total power failure. It allows users to determine if the device has powered up after having lost all power to the device (both V_{DD} and V_{BAT}).

Brownout Detection

The ISL12020 monitor the V_{DD} level continuously and provide warning if the V_{DD} level drops below prescribed levels. There are six (6) levels that can be selected for the trip level. These values are 85% below popular V_{DD} levels. The LVDD bit in the Status Register will be set to "1" when Brownout is detected. Note. The I²C serial bus remains active unless the Battery V_{trip} levels are reached.

Battery Level Monitor

The ISL12020 have a built in warning feature once the Backup battery level drops first to 85% and then to 75% of the battery's nominal VBAT level. When the battery voltage drops to between 85% and 75%, the LBAT85 bit is set in the status register. When the level drops below 75%, both LBAT85 and LBAT75 bits are set in the status register.

There is a Battery Timestamp Function available. Once the VDD is low enough to enable switchover to the battery, the RTC time/date are written into the TSVTB register. This information can be read from the TSVTB registers to discover the point in time of the VDD powerdown. If there are multiple powerdown cycles before reading these registers, the first values stored in these registers will be retained. These registers will hold the original powerdown value until they are cleared by writing "00h" to each register.

Low Power Mode

The normal power switching of the ISL12020 is designed to switch into battery backup mode only if the VDD power is lost. This will ensure that the device can accept a wide range of backup voltages from many types of sources while reliably switching into backup mode. Another mode (called Low Power Mode) is available to allow direct switching from VDD to VBAT without requiring VDD to drop below VTRIP. Since the additional monitoring of VDD vs VTRIP is no longer needed, that circuitry is shut down and less power is used while operating from VDD. Power savings are typically 600nA at VDD = 5V. Low Power Mode is activated via the BSW bit in the control and status registers.

Low Power Mode is useful in systems where VDD is normally higher than VBAT at all times. The device will switch from VDD to VBAT when VDD drops below VBAT, with about 50mV of hysteresis to prevent any switchback of VDD after switchover. In a system with VDD = 5V and backup lithium battery of VBAT = 3V, Low Power Mode can be used. However, it is not recommended to use Low Power Mode in a system with VDD = 3.3V ±10%, VBAT ≥ 3.0V, and when there is a finite I-R voltage drop in the VDD line.

Real Time Clock Operation

The Real Time Clock (RTC) uses an external 32.768kHz quartz crystal to maintain an accurate internal representation of second, minute, hour, day of week, date, month, and year. The RTC also has leap-year correction. The clock also corrects for months having fewer than 31 days and has a bit that controls 24 hour or AM/PM format. When the ISL12020 powers up after the loss of both VDD and VBAT, the clock will not begin incrementing until at least one byte is written to the clock register.

Single Event and Interrupt

The alarm mode is enabled via the MSB bit. Choosing single event or interrupt alarm mode is selected via the IM bit. Note

that when the frequency output function is enabled, the alarm function is disabled.

The standard alarm allows for alarms of time, date, day of the week, month, and year. When a time alarm occurs in single event mode, an IRQ pin will be pulled low and the alarm status bit (ALM) will be set to "1".

The pulsed interrupt mode allows for repetitive or recurring alarm functionality. Hence, once the alarm is set, the device will continue to alarm for each occurring match of the alarm and present time. Thus, it will alarm as often as every minute (if only the nth second is set) or as infrequently as once a year (if at least the nth month is set). During pulsed interrupt mode, the IRQ pin will be pulled low for 250ms and the alarm status bit (ALM) will be set to "1".

The ALM bit can be reset by the user or cleared automatically using the auto reset mode (see ARST bit). The alarm function can be enabled/disabled during battery backup mode using the FOBATB bit. For more information on the alarm, please see "ALARM Registers (10h to 15h)" on page 17.

Frequency Output Mode

The ISL12020 has the option to provide a clock output signal using the IRQ/FOUT open drain output pin. The frequency output mode is set by using the FO bits to select 15 possible output frequency values from 1/32Hz to 32kHz. The frequency output can be enabled/disabled during battery backup mode using the FOBATB bit.

General Purpose User SRAM

The ISL12020 provides 128 bytes of user SRAM. The SRAM will continue to operate in battery backup mode. However, it should be noted that the I²C bus is disabled in battery backup mode.

I²C Serial Interface

The ISL12020 has an I²C serial bus interface that provides access to the control and status registers and the user SRAM. The I²C serial interface is compatible with other industry I²C serial bus protocols using a bi-directional data signal (SDA) and a clock signal (SCL).

Oscillator Compensation

The ISL12020 provides both initial timing correction and temperature correction due to variation of the crystal oscillator. Analog and Digital trimming control is provided for initial adjustment, and a temperature compensation function is provided to automatically correct for temperature drift of the crystal. Initial values for the temperature coefficient (ALPHA) and crystal capacitance (BETA) are required for best accuracy. The function can be enabled/disabled at any time and can be used in battery mode as well.

Register Descriptions

The battery-backed registers are accessible following a slave byte of "1101111x" and reads or writes to addresses [00h:13h]. The defined addresses and default values are described in the Table 1. The battery backed general purpose SRAM has a different slave address (1010111x), so it is not possible to read/write that section of memory while accessing the registers.

REGISTER ACCESS

The contents of the registers can be modified by performing a byte or a page write operation directly to any register address.

The registers are divided into 8 sections. They are:

1. Real Time Clock (7 bytes): Address 00h to 06h.
2. Control and Status (9 bytes): Address 07h to 0Fh.
3. Alarm (6 bytes): Address 10h to 15h.
4. Time Stamp for Battery Status (5 bytes): Address 16h to 1Ah.
5. Time Stamp for VDD Status (5 bytes): Address 1Bh to 1Fh.
6. Day Light Saving Time (8 bytes): 20h to 27h.
7. TEMP (2 bytes): 28h to 29h
8. Scratch Pad (6 bytes): Address 2Ah to 2Fh.

Write capability is allowable into the RTC registers (00h to 06h) only when the WRTC bit (bit 6 of address 08h) is set to "1". **A multi-byte read or write operation is limited to one section per operation.** Access to another section requires a new operation. A read or write can begin at any address within the section.

A register can be read by performing a random read at any address at any time. This returns the contents of that register location. Additional registers are read by performing a sequential read. For the RTC and Alarm registers, the read instruction latches all clock registers into a buffer, so an update of the clock does not change the time being read. At the end of a read, the master supplies a stop condition to end the operation and free the bus. After a read, the address remains at the previous address +1 so the user can execute a current address read and continue reading the next register.

It is not necessary to set the WRTC bit prior to writing into the control and status, alarm, and user SRAM registers.

EEPW.com.cn 电子產品世界

ISL12020

TABLE 1. REGISTER MEMORY MAP

ADDR.	SECTION	REG NAME	BIT								RANGE	DEFAULT
			7	6	5	4	3	2	1	0		
00h	RTC	SC	0	SC22	SC21	SC20	SC13	SC12	SC11	SC10	0 to 59	00h
01h		MN	0	MN22	MN21	MN20	MN13	MN12	MN11	MN10	0 to 59	00h
02h		HR	MIL	0	HR21	HR20	HR13	HR12	HR11	HR10	0 to 23	00h
03h		DT	0	0	DT21	DT20	DT13	DT12	DT11	DT10	1 to 31	01h
04h		MO	0	0	0	MO20	MO13	MO12	MO11	MO10	1 to 12	01h
05h		YR	YR23	YR22	YR21	YR20	YR13	YR12	YR11	YR10	0 to 99	00h
06h		DW	0	0	0	0	0	DW2	DW1	DW0	0 to 6	00h
07h	CSR	SR	BUSY	OSCF	DSTADJ	ALM	LVDD	LBAT85	LBAT75	RTCF	N/A	01h
08h		INT	ARST	WRTC	IM	FOBATB	FO3	FO2	FO1	FO0	N/A	00h
09h		PWR_VDD	CLRTS	D	D	D	D	V _{DD} Trip2	V _{DD} Trip1	V _{DD} Trip0	N/A	00h
0Ah		PWR_VBAT	BSW	D	VB85Tp2	VB85Tp1	VB85Tp0	VB75Tp2	VB75Tp1	VB75Tp0	N/A	00h
0Bh		ITRO	IDTR01	IDTR00	IATR05	IATR04	IATR03	IATR02	IATR01	IATR00	N/A	08h
0Ch		ALPHA	D	ALPHA6	ALPHA5	ALPHA4	ALPHA3	ALPHA2	ALPHA1	ALPHA0	N/A	25h
0Dh		BETA	TSE	BTSE	BTSR	D	BETA3	BETA2	BETA1	BETA0	N/A	08h
0Eh		FATR	0	0	FFATR5	FATR4	FATR3	FATR2	FATR1	FATR0	N/A	00h
0Fh		FDTR	0	0	0	0	0	FDTR2	FDTR1	FDTR0	N/A	00h
10h	ALARM	SCA0	ESCA0	SCA022	SCA021	SCA020	SCA013	SCA012	SCA011	SCA010	00 to 59	00h
11h		MNA0	EMNA0	MNA022	MNA021	MNA020	MNA013	MNA012	MNA011	MNA010	00 to 59	00h
12h		HRA0	EHRA0	D	HRA021	HRA020	HRA013	HRA012	HRA011	HRA010	0 to 23	00h
13h		DTA0	EDTA0	D	DTA021	DTA020	DTA013	DTA012	DTA011	DTA010	01 to 31	01h
14h		MOA0	EMOA00	D	D	MOA020	MOA013	MOA012	MOA011	MOA010	01 to 12	01h
15h		DWA0	EDWA0	D	D	D	D	DWA02	DWA01	DWA00	0 to 6	00h
16h	TSV2B	VSC	0	VSC22	VSC21	VSC20	VSC13	VSC12	VSC11	VSC10	0 to 59	00h
17h		VMN	0	VMN22	VMN21	VMN20	VMN13	VMN12	VMN11	VMN10	0 to 59	00h
18h		VHR	VMIL	0	VHR21	VHR20	VHR13	VHR12	VHR11	VHR10	0 to 23	00h
19h		VDT	0	0	VDT21	VDT20	VDT13	VDT12	VDT11	VDT10	1 to 31	00h
1Ah		VMO	0	0	0	VMO20	VMO13	VMO12	VMO11	VMO10	1 to 12	00h
1Bh	TSB2V	BSC	0	BSC22	BSC21	BSC20	BSC13	BSC12	BSC11	BSC10	0 to 59	00h
1Ch		BMN	0	BMN22	BMN21	BMN20	BMN13	BMN12	BMN11	BMN10	0 to 59	00h
1Dh		BHR	BMIL	0	BHR21	BHR20	BHR13	BHR12	BHR11	BHR10	0 to 23	00h
1Eh		BDT	0	0	BDT21	BDT20	BDT13	BDT12	BDT11	BDT10	1 to 31	00h
1Fh		BMO	0	0	0	BMO20	BMO13	BMO12	BMO11	BMO10	1 to 12	00h

ISL12020

TABLE 1. REGISTER MEMORY MAP (Continued)

ADDR.	SECTION	REG NAME	BIT								RANGE	DEFAULT
			7	6	5	4	3	2	1	0		
20h	DSTCR	DstMoFd	DSTE	D	D	DstMoFd20	DstMoFd13	DstMoFd12	DstMoFd11	DstMoFd10	1 to 12	00h
21h		DstDwFd	DstDwEFd	D	D	D	D	DstDwFd12	DstDwFd11	DstDwFd10	0 to 6	00h
22h		DstDtFd	D	D	DstDtFd21	DstDtFd20	DstDtFd13	DstDtFd12	DstDtFd11	DstDtFd10	1 to 31	00h
23h		DstHrFd	D	D	DstHrFd21	DstHrFd20	DstHrFd13	DstHrFd12	DstHrFd11	DstHrFd10	0 to 23	00h
24h		DstMoRv	D	D	D	XDstMoRv20	DstMoRv13	DstMoR12v	DstMoRv11	DstMoRv10	01 to 12	00h
25h		DstDwRv	DstDwERv	D	D	D	D	DstDwRv12	DstDwRv11	DstDwRv10	0 to 6	00h
26h		DstDtrv	D	D	DstDtrv21	DstDtrv20	DstDtrv13	DstDtrv12	DstDtrv11	DstDtrv10	01 to 31	00h
27h		DstHrRv	D	D	DstHrRv21	DstHrRv20	DstHrRv13	DstHrRv12	DstHrRv11	DstHrRv10	0 to 23	00h
28h	TEMP	TK0L	TK07	TK06	TK05	TK04	TK03	TK02	TK01	TK00	00 to FF	00h
29h		TK0M	0	0	0	0	0	0	TK09	TK08	00 to 03	00h
2Ah	GPM	GPM1	GPM17	GPM16	GPM15	GPM14	GPM13	GPM12	GPM11	GPM10	00 to FF	00h
2Bh		GPM2	GPM27	GPM26	GPM25	GPM24	GPM23	GPM22	GPM21	GPM20	00 to FF	00h
2Ch		GPM3	GPM37	GPM36	GPM35	GPM34	GPM33	GPM32	GPM31	GPM30	00 to FF	00h
2Dh		GPM4	GPM47	GPM46	GPM45	GPM44	GPM43	GPM42	GPM41	GPM40	00 to FF	00h
2Eh		GPM5	GPM57	GPM56	GPM55	GPM54	GPM53	GPM52	GPM51	GPM50	00 to FF	00h
2Fh		GPM6	GPM67	GPM66	GPM65	GPM64	GPM63	GPM62	GPM61	GPM60	00 to FF	00h

Real Time Clock Registers

Addresses [00h to 06h]

RTC REGISTERS (SC, MN, HR, DT, MO, YR, DW)

These registers depict BCD representations of the time. As such, SC (Seconds) and MN (Minutes) range from 0 to 59, HR (Hour) can either be a 12-hour or 24-hour mode, DT (Date) is 1 to 31, MO (Month) is 1 to 12, YR (Year) is 0 to 99, and DW (Day of the Week) is 0 to 6.

The DW register provides a Day of the Week status and uses three bits DW2 to DW0 to represent the seven days of the week. The counter advances in the cycle 0-1-2-3-4-5-6-0-1-2-... The assignment of a numerical value to a specific day of the week is arbitrary and may be decided by the system software designer. The default value is defined as "0".

24 HOUR TIME

If the MIL bit of the HR register is "1", the RTC uses a 24-hour format. If the MIL bit is "0", the RTC uses a 12-hour format and HR21 bit functions as an AM/PM indicator with a "1" representing PM. The clock defaults to 12-hour format time with HR21 = "0".

LEAP YEARS

Leap years add the day February 29 and are defined as those years that are divisible by 4. Years divisible by 100 are not leap years, unless they are also divisible by 400. This means that the year 2000 is a leap year and the year 2100 is not. The ISL12020 does not correct for the leap year in the year 2100.

Control and Status Registers (CSR)

Addresses [07h to 0Fh]

The Control and Status Registers consist of the Status Register, Interrupt and Alarm Register, Analog Trimming and Digital Trimming Registers.

Status Register (SR)

The Status Register is located in the memory map at address 07h. This is a volatile register that provides either control or status of RTC failure (RTCF), Battery Level Monitor (LBAT85, LBAT75), alarm trigger, Daylight Saving Time, crystal oscillator enable and temperature conversion in progress bit.

TABLE 2. STATUS REGISTER (SR)

ADDR	7	6	5	4	3	2	1	0
07h	BUSY	OSCF	DSTDJ	ALM	LVDD	LBAT85	LBAT75	RTCF

BUSY BIT (BUSY)

Busy Bit indicates temperature sensing is in progress. In this mode, Alpha, Beta and ITRO registers are disabled and cannot be accessed.

OSCILLATOR FAIL BIT (OSCF)

Indicates oscillator stopped.

DAYLIGHT SAVING TIME CHANGE BIT (DSTADJ)

DSTADJ is the Daylight Saving Time Adjusted Bit. It indicates the daylight saving time adjustment has happened. DSTADJ is reset to 0 upon power up. If DST event happens (at either the beginning or the end of DST), DSTADJ will be set to 1. A read of the SR will reset the DSTADJ, or it will be automatically reset on the following month.

ALARM BIT (ALM)

These bits announce if the alarm matches the real time clock. If there is a match, the respective bit is set to "1". This bit can be manually reset to "0" by the user or automatically reset by enabling the auto-reset bit (see ARST bit). A write to this bit in the SR can only set it to "0", not "1". An alarm bit that is set by an alarm occurring during an SR read operation will remain set after the read operation is complete.

LOW V_{DD} INDICATOR BIT (LV_{DD}VDD)

Indicates V_{DD} dropped below the pre-selected trip level. (Brown Out Mode). The Trip points for Brown Out levels are selected by three bits V_{DD}Trip2, V_{DD}Trip1 and V_{DD}Trip0 in PWR_V_{DD} registers.

LOW BATTERY INDICATOR 85% BIT (LBAT85)

Indicates battery level dropped below the pre-selected trip levels (85% of battery voltage). The trip points are selected by three bits: VB85Tp2, VB85Tp1 and VB85Tp0 in the PWR_VBAT registers.

LOW BATTERY INDICATOR 75% BIT (LBAT75)

Indicates battery level dropped below the pre-selected trip levels (75% of battery voltage). The trip points are selected by three bits VB75Tp2, VB75Tp1 and VB75Tp0 in the PWR_VBAT registers.

REAL TIME CLOCK FAIL BIT (RTCF)

This bit is set to a "1" after a total power failure. This is a read only bit that is set by hardware (ISL12020 internally) when the device powers up after having lost all power (defined as V_{DD} = 0V and V_{BAT} = 0V). The bit is set regardless of whether V_{DD} or V_{BAT} is applied first. The loss of only one of the supplies does not set the RTCF bit to "1". The first valid write to the RTC section after a complete power failure resets the RTCF bit to "0" (writing one byte is sufficient).

Interrupt Control Register (INT)

TABLE 3. INTERRUPT CONTROL REGISTER (INT)

ADDR	7	6	5	4	3	2	1	0
08h	ARST	WRTC	IM	FOBATB	FO3	FO2	FO1	FO0

AUTOMATIC RESET BIT (ARST)

This bit enables/disables the automatic reset of the ALM, LVDD, LBAT85, and LBAT75 status bits only. When ARST bit is set to "1", these status bits are reset to "0" after a valid read of the respective status register (with a valid STOP

condition). When the ARST is cleared to “0”, the user must manually reset the ALM, LVDD, LBAT85, and LBAT75 bits.

WRITE RTC ENABLE BIT (WRTC)

The WRTC bit enables or disables write capability into the RTC Timing Registers. The factory default setting of this bit is “0”. Upon initialization or power up, the WRTC must be set to “1” to enable the RTC. Upon the completion of a valid write (STOP), the RTC starts counting. The RTC internal 1Hz signal is synchronized to the STOP condition during a valid write cycle.

INTERRUPT/ALARM MODE BIT (IM)

This bit enables/disables the interrupt mode of the alarm function. When the IM bit is set to “1”, the alarm will operate in the interrupt mode, where an active low pulse width of 250ms will appear at the \overline{IRQ}/F_{OUT} pin when the RTC is triggered by the alarm as defined by the alarm registers (0Ch to 11h). When the IM bit is cleared to “0”, the alarm will operate in standard mode, where the \overline{IRQ}/F_{OUT} pin will be set low until the ALM status bit is cleared to “0”.

TABLE 4.

IM BIT	INTERRUPT/ALARM FREQUENCY
0	Single Time Event Set By Alarm
1	Repetitive/Recurring Time Event Set By Alarm

FREQUENCY OUTPUT AND INTERRUPT BIT (FOBATB)

This bit enables/disables the F_{OUT}/\overline{IRQ} pin during battery backup mode (i.e. V_{BAT} power source active). When the FOBATB is set to “1” the F_{OUT}/\overline{IRQ} pin is disabled during battery backup mode. This means that both the frequency output and alarm output functions are disabled. When the FOBATB is cleared to “0”, the F_{OUT}/\overline{IRQ} pin is enabled during battery backup mode. Note that the open drain F_{OUT}/\overline{IRQ} pin will need a pullup to the battery voltage to operate in battery backup mode.

FREQUENCY OUT CONTROL BITS (FO <3:0>)

These bits enable/disable the frequency output function and select the output frequency at the \overline{IRQ}/F_{OUT} pin. See Table 5 for frequency selection. When the frequency mode is enabled, it will override the alarm mode at the \overline{IRQ}/F_{OUT} pin.

TABLE 5. FREQUENCY SELECTION OF FOUT PIN

FREQUENCY, FOUT	UNITS	FO3	FO2	FO1	FO0
0	Hz	0	0	0	0
32768	Hz	0	0	0	1
4096	Hz	0	0	1	0
1024	Hz	0	0	1	1
64	Hz	0	1	0	0
32	Hz	0	1	0	1

TABLE 5. FREQUENCY SELECTION OF FOUT PIN (Continued)

FREQUENCY, FOUT	UNITS	FO3	FO2	FO1	FO0
16	Hz	0	1	1	0
8	Hz	0	1	1	1
4	Hz	1	0	0	0
2	Hz	1	0	0	1
1	Hz	1	0	1	0
1/2	Hz	1	0	1	1
1/4	Hz	1	1	0	0
1/8	Hz	1	1	0	1
1/16	Hz	1	1	1	0
1/32	Hz	1	1	1	1

POWER SUPPLY CONTROL REGISTER (PWR_VDD)

Clear Time Stamp Bit (CLRSTS)

ADDR	7	6	5	4	3	2	1	0
09h	CLRSTS	0	0	0	0	$V_{DD}Trip2$	$V_{DD}Trip1$	$V_{DD}Trip0$

This bit clears Time Stamp V_{DD} to Battery (TSV2B) and Time Stamp Battery to V_{DD} Registers (TSB2V). The default setting is 0 (CLRSTS = 0) and the Enabled setting is 1 (CLRSTS = 1)

V_{DD} Brown Out Trip Voltage BITS ($V_{DD}Trip$)<2:0

These bits set the 6 trip levels for the V_{DD} alarm, indicating that V_{DD} has dropped below a preset level, in this event, the LVDD bit in the Status Register is set to “1”. See Table 6.

TABLE 6. VDD TRIP LEVELS

$V_{DD}Trip2$	$V_{DD}Trip1$	$V_{DD}Trip0$	TRIP VOLTAGE (V)
0	0	0	2.295
0	0	1	2.550
0	1	0	2.805
0	1	1	3.060
1	0	0	4.250
1	0	1	4.675

Battery Voltage Trip Voltage Register (PWR_VBAT)

This register controls the trip points for the two VBAT alarms, with levels set to approximately 85% and 75% of the nominal battery level.

TABLE 7.

ADDR	7	6	5	4	3	2	1	0
0Ah	BSW	0	VB85 Tp2	VB85 Tp1	VB85 Tp0	VB75 Tp2	VB75 Tp1	VB75 Tp0

BATTERY SWITCHOVER BIT (BSW)

This bit selects either standard mode or low power mode battery switchover. In standard Mode (BSW = 0), the V_{DD} switches over to battery at the low trip point, typically 2.2V. In Low Power Mode (BSW = 1), V_{DD} switches over to battery at the battery voltage (V_{BAT}). Low power mode uses less power in battery backup for applications requiring longer backup times.

BATTERY LEVEL MONITOR TRIP BITS (VB85TP <2:0>)

Three bits selects the first alarm (85% of Nominal VBAT) level for the battery voltage monitor. There are total of 7 levels that could be selected for the first alarm. Any of the of levels could be selected as the first alarm with no reference as to nominal Battery voltage level. See Table 8.

TABLE 8. VB85T ALARM LEVEL

VB85Tp2	VB85Tp1	VB85Tp0	BATTERY ALARM TRIP LEVEL (V)
0	0	0	2.125
0	0	1	2.295
0	1	0	2.550
0	1	1	2.805
1	0	0	3.060
1	0	1	4.250
1	1	0	4.675

BATTERY LEVEL MONITOR TRIP BITS (VB75TP <2:0>)

Three bits selects the second alarm (75% of Nominal VBAT) level for the battery voltage monitor. There are total of 7 levels that could be selected for the second alarm. Any of the of levels could be selected as the second alarm with no reference as to nominal Battery voltage level. See Table 9.

TABLE 9. BATTERY LEVEL MONITOR TRIP BITS (VB75TP <2:0>)

VB75Tp2	VB75Tp1	VB75Tp0	BATTERY ALARM TRIP LEVEL (V)
0	0	0	1.875
0	0	1	2.025
0	1	0	2.250
0	1	1	2.475
1	0	0	2.700
1	0	1	3.750
1	1	0	4.125

Initial ATR and DTR setting Register (ITRO)

These bits are to be used to trim the initial error (at room temperature) of the crystal. Both digital (DTR) and analog (ATR) trimming methods are available. The digital trimming uses clock pulse skipping and insertion for frequency adjustment. Analog trimming uses load capacitance adjustment to pull the oscillator frequency. A range of +64ppm to -63ppm is possible with combined Digital and Analog trimming.

AGING AND INITIAL TRIM DIGITAL TRIMMING BITS (IDTR0) <2:0>

These bits allow ± 32 ppm initial trimming range for the crystal frequency. This is meant to be a coarse adjustment if the range needed is outside that of the IATR control. See Table 10. The IDTR0 register should only be changed while the TSE (Temp Sense Enable) bit is "0".

TABLE 10. IDTR0 TRIMMING RANGE

IDTR01	IDTR00	TRIMMING RANGE
0	0	Default /Disabled
0	1	+32ppm
1	0	0ppm
1	1	-32ppm

AGING AND INITIAL ANALOG TRIMMING BITS (IATRO) <6:0>

The analog trimming register allows +32ppm to -31ppm adjustment in 1ppm/bit increments. This enables fine frequency adjustment for trimming initial crystal accuracy error or to correct for aging drift. The IATRO register should only be changed while the TSE (temp sense enable) bit is "0".

TABLE 11. INITIAL ATR AND DTR SETTING REGISTER

ADDR	7	6	5	4	3	2	1	0
0Bh	IDTR01	IDTR00	IATR05	IATR04	IATR03	IATR02	IATR01	IATR00

TABLE 12. IATRO TRIMMING RANGE

IATR05	IATR04	IATR03	IATR02	IATR01	IATR00	TRIMMING RANGE
0	0	0	0	0	0	+32
0	0	0	0	0	1	+31
0	0	0	0	1	0	+30
0	0	0	0	1	1	+29
0	0	0	1	0	0	+28
0	0	0	1	0	1	+27
0	0	0	1	1	0	+26
0	0	0	1	1	1	+25
0	0	1	0	0	0	+24
0	0	1	0	0	1	+23
0	0	1	0	1	0	+22
0	0	1	0	1	1	+21

ISL12020

TABLE 12. IATRO TRIMMING RANGE (Continued)

IATR05	IATR04	IATR03	IATR02	IATR01	IATR00	TRIMMING RANGE
0	0	1	1	0	0	+20
0	0	1	1	0	1	+19
0	0	1	1	1	0	+18
0	0	1	1	1	1	+17
0	1	0	0	0	0	+16
0	1	0	0	0	1	+15
0	1	0	0	1	0	+14
0	1	0	0	1	1	+13
0	1	0	1	0	0	+12
0	1	0	1	0	1	+11
0	1	0	1	1	0	+10
0	1	0	1	1	1	+9
0	1	1	0	0	0	+8
0	1	1	0	0	1	+7
0	1	1	0	1	0	+6
0	1	1	0	1	1	+5
0	1	1	1	0	0	+4
0	1	1	1	0	1	+3
0	1	1	1	1	0	+2
0	1	1	1	1	1	+1
1	0	0	0	0	0	0
1	0	0	0	0	1	-1
1	0	0	0	1	0	-2
1	0	0	0	1	1	-3
1	0	0	1	0	0	-4
1	0	0	1	0	1	-5
1	0	0	1	1	0	-6
1	0	0	1	1	1	-7
1	0	1	0	0	0	-8
1	0	1	0	0	1	-9
1	0	1	0	1	0	-10
1	0	1	0	1	1	-11
1	0	1	1	0	0	-12
1	0	1	1	0	1	-13
1	0	1	1	1	0	-14
1	0	1	1	1	1	-15
1	1	0	0	0	0	-16
1	1	0	0	0	1	-17
1	1	0	0	1	0	-18
1	1	0	0	1	1	-19
1	1	0	1	0	0	-20
1	1	0	1	0	1	-21
1	1	0	1	1	0	-22
1	1	0	1	1	1	-23
1	1	1	0	0	0	-24
1	1	1	0	0	1	-25
1	1	1	0	1	0	-26
1	1	1	0	1	1	-27
1	1	1	1	0	0	-28
1	1	1	1	0	1	-29
1	1	1	1	1	0	-30
1	1	1	1	1	1	-31

ALPHA Register (ALPHA)

TABLE 13. ALPHA REGISTER

ADDR	7	6	5	4	3	2	1	0
0Ch	0	ALPHA6	ALPHA5	ALPHA4	ALPHA3	ALPHA2	ALPHA1	ALPHA0

The Alpha variable is 7 bits and is defined as the temperature coefficient of Crystal, normally given in units of ppm/°C² = and with a typical value of -0.034. The ISL12020 devices use a scaled version of the absolute value of this coefficient in order to get an integer value. Therefore, Alpha <6:0> is defined as the (|Actual Alpha Value| x 1024) and converted to binary. For example, a crystal with Alpha of -0.034ppm/°C² is first scaled:

$|1024 * (-0.034)| = 35d$ and then converted to a binary number of 0100011b.

The practical range of Actual Alpha values is from -0.020 to -0.060.

The ALPHA register should only be changed while the TSE (Temp Sense Enable) bit is "0".

BETA Register (BETA)

TABLE 14.

ADDR	7	6	5	4	3	2	1	0
0Dh	TSE	BTSE	BTSR	0	BETA3	BETA2	BETA1	BETA0

TEMPERATURE SENSOR ENABLED BIT (TSE)

This bit enables the Temperature Sensing operation, including the temperature sensor, A/D converter and ATR/DTR register adjustment. The default mode after power up is disabled (TSE = 0). To enable the operation, TSE should be set to 1 (TSE = 1). When temp sense is disabled, the initial values for IATR and IDTR registers are used for frequency control.

All changes to the IDTR, IATR, ALPHA and BETA registers must be made with TSE = 0. After loading the new values, then TSE can be enabled and the new values are used.

TEMP SENSOR CONVERSION IN BATTERY MODE BIT (BTSE)

This bit enables the Temperature Sensing and Correction in battery mode. BTSE = 0 default no conversion in battery mode. BTSE = 1 Temp Sensing enabled in battery mode. The BTSE is disabled when battery voltage is lower than 2.6V.

FREQUENCY OF TEMPERATURE SENSING AND CORRECTION BIT (BTSR)

This bit controls the frequency of Temp Sensing and Correction. BTSR = 0 default mode is every 10 minutes, BTSR = 1 is every 1.0 minute. Note that BTSE has to be enabled in both cases. See Table 15.

TABLE 15. FREQUENCY OF TEMPERATURE SENSING AND CORRECTION BIT

BTSE	BTSR	TC PERIOD IN BATTERY MODE
0	0	OFF
0	1	OFF
1	0	10 Minutes
1	1	1 Minute

GAIN FACTOR OF ATR BIT (BETA)<3:0>

Beta is specified to take care of the C_m variations of the crystal. Most crystals specify C_m around 2.2fF. For example, if $C_m > 2.2fF$, the actual ATR steps may reduce from 1ppm/step to approximately 0.80ppm/step. Beta is then used to adjust for this variation and restore the step size to 1ppm/step.

The value for BETA should only be changed while the TSE (Temp Sense Enable) bit is "0". The procedure for writing the BETA register involves two steps. First, Write the new value of BETA with TSE = 0. Then Write the same value of BETA with TSE = 1. This will insure the next temp sense cycle will use the new BETA value. BETA values are limited in the range from 0100 to 1100 as shown in Table 16.

TABLE 16. BETA VALUES

BETA<3:0>	ATR STEP ADJUSTMENT
0100	0.500
0101	0.625
0110	0.750
0111	0.875
1000	1.00
1001	1.125
1010	1.250
1011	1.375
1100	1.500

Final Analog Trimming Register (FATR)

This register shows the final setting of ATR after temperature correction. It is read-only, the user cannot overwrite a value to this register. This value is accessible as a means of monitoring the temperature compensation function. See Table 17.

TABLE 17. FINAL ANALOG TRIMMING REGISTER

ADDR	7	6	5	4	3	2	1	0
0Eh	0	0	FATR5	FATR4	FATR3	FATR2	FATR1	FATR0

Final Digital Trimming Register (FDTR)

This Register shows the final setting of DTR after temperature correction. It is read-only, the user cannot overwrite a value to this register. The value is accessible as a means of monitoring the temperature compensation function. The corresponding clock adjustment values are shown in Table 19. The DTR setting is only positive as it is used to correct for the negative drift of a normal crystal over temperature.

TABLE 18. FINAL DIGITAL TRIMMING REGISTER

ADDR	7	6	5	4	3	2	1	0
0Fh						FDTR2	FDTR1	FDTR0

TABLE 19. CLOCK ADJUSTMENT VALUES FOR FINAL DIGITAL TRIMMING REGISTER

DTR<2:0>	DECIMAL	ppm ADJUSTMENT
000	0	0
001	1	32
010	2	64
011	3	96
100	4	128
101	5	160
110	6	196
111	7	-32

ALARM Registers (10h to 15h)

The alarm register bytes are set up identical to the RTC register bytes, except that the MSB of each byte functions as an enable bit (enable = "1"). These enable bits specify which alarm registers (seconds, minutes, etc.) are used to make the comparison. Note that there is no alarm byte for year.

The alarm function works as a comparison between the alarm registers and the RTC registers. As the RTC advances, the alarm will be triggered once a match occurs between the alarm registers and the RTC registers. Any one alarm register, multiple registers, or all registers can be enabled for a match.

There are two alarm operation modes: Single Event and periodic Interrupt Mode:

- **Single Event Mode** is enabled by setting the bit 7 on any of the Alarm registers (ESCA0... EDWA0) to "1", the IM bit to "0", and disabling the frequency output. This mode permits a one-time match between the Alarm registers and the RTC registers. Once this match occurs, the ALM bit is set to "1" and the IRQ output will be pulled low and will remain low until the ALM bit is reset. This can be done manually or by using the auto-reset feature.
- **Interrupt Mode** is enabled by setting the bit 7 on any of the Alarm registers (ESCA0... EDWA0) to "1", the IM bit to

"1", and disabling the frequency output. The \overline{IRQ} output will now be pulsed each time an alarm occurs. This means that once the interrupt mode alarm is set, it will continue to alarm for each occurring match of the alarm and present time. This mode is convenient for hourly or daily hardware interrupts in microcontroller applications such as security cameras or utility meter reading.

To clear a single event alarm, the ALM bit in the status register must be set to "0" with a write. Note that if the ARST bit is set to 1 (address 08h, bit 7), the ALM bit will automatically be cleared when the status register is read.

Following are examples of both Single Event and periodic Interrupt Mode alarms.

Example 1

- Alarm set with single interrupt (IM = "0")
- A single alarm will occur on January 1 at 11:30am.
- Set Alarm registers as follows:

ALARM REGISTER	BIT								HEX	DESCRIPTION
	7	6	5	4	3	2	1	0		
SCA0	0	0	0	0	0	0	0	0	00h	Seconds disabled
MNA0	1	0	1	1	0	0	0	0	B0h	Minutes set to 30, enabled
HRA0	1	0	0	1	0	0	0	1	91h	Hours set to 11, enabled
DTA0	1	0	0	0	0	0	0	1	81h	Date set to 1, enabled
MOA0	1	0	0	0	0	0	0	1	81h	Month set to 1, enabled
DWA0	0	0	0	0	0	0	0	0	00h	Day of week disabled

After these registers are set, an alarm will be generated when the RTC advances to exactly 11:30am on January 1 (after seconds changes from 59 to 00) by setting the ALM bit in the status register to "1" and also bringing the \overline{IRQ} output low.

Example 2

- Pulsed interrupt once per minute (IM = "1")
- Interrupts at one minute intervals when the seconds register is at 30 seconds.
- Set Alarm registers as follows:

ALARM REGISTER	BIT								HEX	DESCRIPTION
	7	6	5	4	3	2	1	0		
SCA0	1	0	1	1	0	0	0	0	B0h	Seconds set to 30, enabled
MNA0	0	0	0	0	0	0	0	0	00h	Minutes disabled
HRA0	0	0	0	0	0	0	0	0	00h	Hours disabled
DTA0	0	0	0	0	0	0	0	0	00h	Date disabled

ALARM REGISTER	BIT								HEX	DESCRIPTION
	7	6	5	4	3	2	1	0		
MOA0	0	0	0	0	0	0	0	0	00h	Month disabled
DWA0	0	0	0	0	0	0	0	0	00h	Day of week disabled

Once the registers are set, the following waveform will be seen at \overline{IRQ} :

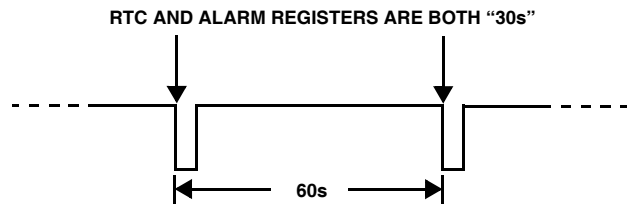

FIGURE 5. \overline{IRQ} WAVEFORM

Note that the status register ALM bit will be set each time the alarm is triggered, but does not need to be read or cleared

Time Stamp V_{DD} to Battery Registers (TSV2B)

The TSV2B Register bytes are identical to the RTC register bytes, except they do not extend beyond the Month. The Time Stamp captures the FIRST V_{DD} to Battery Voltage transition time, and will not update upon subsequent events, until cleared (only the first event is captured before clearing). Set CLRTS = 1 to clear this register (Add 09h, PWR_ V_{DD} register).

Note that the time stamp registers are cleared to all "0", including the month and day, which is different from the RTC and alarm registers (those registers default to 01h). This is the indicator that no time stamping has occurred since the last clear or initial powerup. Once a time stamp occurs, there will be a non-zero time stamp.

Time Stamp Battery to V_{DD} Registers (TSB2V)

The Time Stamp Battery to V_{DD} Register bytes are identical to the RTC register bytes, except they do not extend beyond Month. The Time Stamp captures the LAST transition of V_{BAT} to V_D (only the last event of a series of power up/down events is retained). Set CLRTS = 1 to clear this register (Add 09h, PWR_ V_{DD} register).

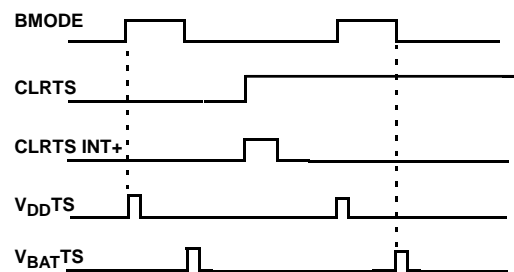

FIGURE 6.

DST Control Registers (DSTCR)

8 bytes of control registers have been assigned for the Daylight Savings Time (DST) functions. DST beginning time is controlled by the registers DstMoFd, DstDwFd, DstDtFd

and DstHrFd. DST ending time is controlled by DstMoRv, DstDwRv, DstDtRv and DstHrRv.

The following tables describe the structure and functions of the DSTCR.

DST FORWARD REGISTERS (20H TO 23H)

DSTE is the DST Enabling Bit located in bit 7 of register 20h (DstMoFdx). Set DSTE = 1 will enable the DSTE function. Upon powering up for the first time (including battery), the DSTE bit defaults to “0”.

The beginning of DST is controlled by the following DST Registers.

DstMoFd sets the Month that DST starts. The default value for the DST begin month is April (04h).

DstDw sets the Day of the Week that DST starts. DstDwFdE sets the priority of the Day of the Week over the Date. For DstDwFdE=1, Day of the week is the priority. Note that Day of the week counts from 0 to 6, like the RTC registers.

The default for the DST Forward Day of the Week is Sunday (80h).

DstDtfd control which Date DST begins. The defaulted value for DST date is on the first date of the month. DstDtFd is only effective if DstDwFdE = 0.

DstHrFd controls the hour that DST begins. It includes the MIL bit which is in the corresponding RTC register. These

two registers need to match formats (Military or AM/PM) in order for the DST function to work. The default value for DST hour is 2:00AM. The time is advanced from 2:00:00AM to 3:00:00AM for this setting.

DST REVERSE REGISTERS (24H TO 27H)

The end of DST is controlled by the following DST Registers.

DstMoRv sets the Month that DST ends. The default value for the DST end month is October (10h).

DstDwRv controls which count of the Day of the Week that DST should end. DstDwRvE sets the priority of the Day of the Week over the Date. For DstDwRvE = 1, Day of the week is the priority. Note that Day of the week counts from 0 to 6, like the RTC registers.

The default for DST end is Sunday (80h).

DstDtRv controls which Date DST ends. The default value DST is set to end is the first date of the month. The DstDtRv is only effective if the DstDwRvE = 0.

DstHrRv controls the hour that DST ends. It includes the MIL bit which is in the corresponding RTC register. These two registers need to match formats (Military or AM/PM) in order for the DST function to work. The default value sets the DST end at 2:00AM. The time is set back from 2:00:00AM to 1:00:00AM for this setting.

TABLE 20. DST FORWARD REGISTERS

Name	7	6	5	4	3	2	1	0
DstMoFd	DSTE	Not Used	Not Used	DstMoFd20	DstMoFd13	DstMoFd12	DstMoFd11	DstMoFd10
DstDwFd	DstDwFdE	Not Used	Not Used	Not Used	Not Used	DstDwFd12	DstDwFd11	DstDwFd10
DstDtFd	Not Used	Not Used	DstDtFd21	DstDtFd20	DstDtFd13	DstDtFd12	DstDtFd11	DstDtFd10
DstHrFd	MIL	Not Used	DstHrFd21	DstHrFd20	DstHrFd13	DstHrFd12	DstHrFd11	DstHrFd10

TABLE 21. DST REVERSE REGISTERS

Name	7	6	5	4	3	2	1	0
DstMoRv	Not Used	Not Used	Not Used	DstMoRv20	DstMoRv13	DstMoRv12	DstMoRv11	DstMoRv10
DstDwRv	DstDwRvE	Not Used	Not Used	Not Used	Not Used	DstDwRv12	DstDwRv11	DstDwRv10
DstDtRv	Not Used	Not Used	DstDtRv21	DstDtRv20	DstDtRv13	DstDtRv12	DstDtRv11	DstDtRv10
DstHrRv	MIL	Not Used	DstHrRv21	DstHrRv20	DstHrRv13	DstHrRv12	DstHrRv11	DstHrRv10

TEMP Registers (TEMP)

The temperature sensor produces an analog voltage output and is input to an A/D converter which outputs a 10-bit temperature value in degrees Kelvin. The output is coded to produce greater resolution for the temperature control. TK07:00 are the LSBs of the code, and TK09:08 are the MSBs of the code. The output code can be converted to degrees Centigrade by first converting from binary to decimal and then subtracting 369d.

$$\text{Temperature in } ^\circ\text{C} = [(\text{TK} <9:0>)/2] - 369 \quad (\text{EQ. 1})$$

The practical range for the temp sensor register output is from 658d to 908d, or -40°C to +85°C.

The TSE bit must be set to "1" to enable temperature sensing.

TABLE 22.

	7	6	5	4	3	2	1	0
TK0L	TK07	TK06	TK05	TK04	TK03	TK02	TK01	TK00
TK0M	0	0	0	0	0	0	TK09	TK08

User Registers (accessed by using Slave Address 1010111x)

Addresses [00h to 7Fh]

These registers are 128 bytes of battery-backed user SRAM.

I²C Serial Interface

The ISL12020 supports a bi-directional bus oriented protocol. The protocol defines any device that sends data onto the bus as a transmitter and the receiving device as the receiver. The device controlling the transfer is the master and the device being controlled is the slave. The master always initiates data transfers and provides the clock for both transmit and receive operations. Therefore, the ISL12020 operates as a slave device in all applications.

All communication over the I²C interface is conducted by sending the MSB of each byte of data first.

Protocol Conventions

Data states on the SDA line can change only during SCL LOW periods. SDA state changes during SCL HIGH are reserved for indicating START and STOP conditions (See Figure 7). On power up of the ISL12020, the SDA pin is in the input mode.

All I²C interface operations must begin with a START condition, which is a HIGH to LOW transition of SDA while SCL is HIGH. The ISL12020 continuously monitors the SDA and SCL lines for the START condition and does not respond to any command until this condition is met (See Figure 7). A START condition is ignored during the power-up sequence.

All I²C interface operations must be terminated by a STOP condition, which is a LOW to HIGH transition of SDA while SCL is HIGH (See Figure 7). A STOP condition at the end of a read operation or at the end of a write operation to memory only places the device in its standby mode.

An acknowledge (ACK) is a software convention used to indicate a successful data transfer. The transmitting device, either master or slave, releases the SDA bus after transmitting eight bits. During the ninth clock cycle, the receiver pulls the SDA line LOW to acknowledge the reception of the eight bits of data (See Figure 8).

The ISL12020 responds with an ACK after recognition of a START condition followed by a valid Identification Byte, and once again after successful receipt of an Address Byte. The ISL12020 also responds with an ACK after receiving a Data Byte of a write operation. The master must respond with an ACK after receiving a Data Byte of a read operation.

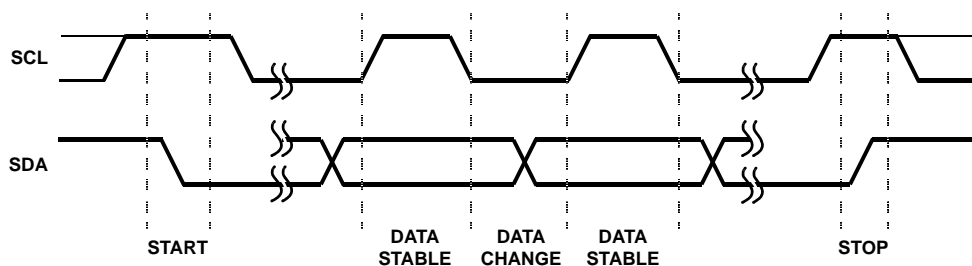

FIGURE 7. VALID DATA CHANGES, START AND STOP CONDITIONS

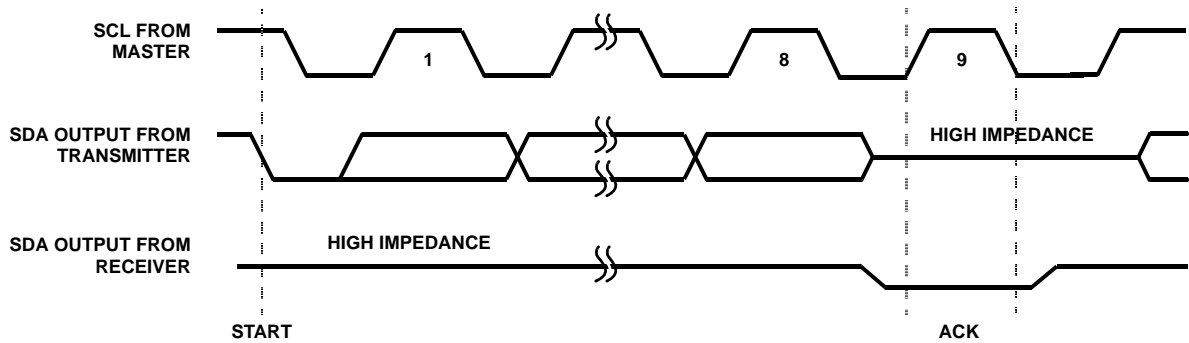

FIGURE 8. ACKNOWLEDGE RESPONSE FROM RECEIVER

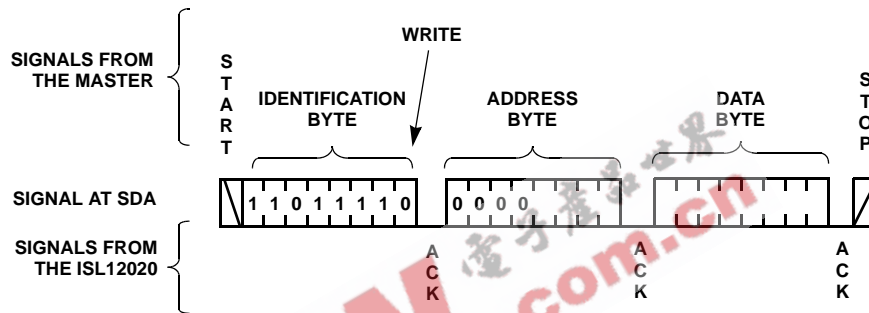

FIGURE 9. BYTE WRITE SEQUENCE (SLAVE ADDRESS FOR CSR SHOWN)

Device Addressing

Following a start condition, the master must output a Slave Address Byte. The 7 MSBs are the device identifier. These bits are “1101111” for the RTC registers and “1010111” for the User SRAM.

The last bit of the Slave Address Byte defines a read or write operation to be performed. When this R/W bit is a “1”, then a read operation is selected. A “0” selects a write operation (refer to Figure 10).

After loading the entire Slave Address Byte from the SDA bus, the ISL12020 compares the device identifier and device select bits with “1101111” or “1010111”. Upon a correct compare, the device outputs an acknowledge on the SDA line.

Following the Slave Byte is a one byte word address. The word address is either supplied by the master device or obtained from an internal counter. On power up the internal address counter is set to address 00h, so a current address read starts at address 00h. When required, as part of a random read, the master must supply the 1 Word Address Bytes as shown in Figure 12.

In a random read operation, the slave byte in the “dummy write” portion must match the slave byte in the “read” section. For a random read of the Control/Status Registers, the slave byte must be “1101111x” in both places.

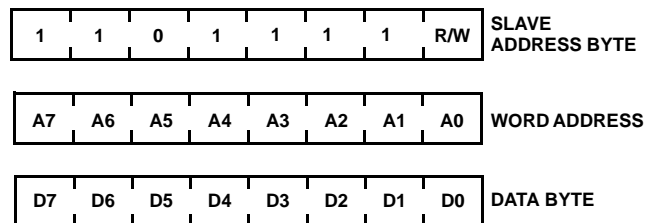

FIGURE 10. SLAVE ADDRESS, WORD ADDRESS, AND DATA BYTES

Write Operation

A Write operation requires a START condition, followed by a valid Identification Byte, a valid Address Byte, a Data Byte, and a STOP condition. After each of the three bytes, the ISL12020 responds with an ACK. At this time, the I²C interface enters a standby state.

Read Operation

A Read operation consists of a three byte instruction followed by one or more Data Bytes (See Figure 12). The master initiates the operation issuing the following sequence: a START, the Identification byte with the R/W bit set to “0”, an Address Byte, a second START, and a second Identification byte with the R/W bit set to “1”. After each of the three bytes, the ISL12020 responds with an ACK. Then

the ISL12020 transmits Data Bytes as long as the master responds with an ACK during the SCL cycle following the eighth bit of each byte. The master terminates the read operation (issuing a STOP condition) following the last bit of the last Data Byte (See Figure 12).

The Data Bytes are from the memory location indicated by an internal pointer. This pointer's initial value is determined by the Address Byte in the Read operation instruction, and increments by one during transmission of each Data Byte. After reaching the memory location 13h, the pointer "rolls over" to 00h, and the device continues to output data for each ACK received.

TABLE 23. SUGGESTED SURFACE MOUNT CRYSTALS

MANUFACTURER	PART NUMBER
Citizen	CM200S
Epson	MC-405, MC-406
Raltron	RSM-200S
SaRonix	32S12
Ecliptek	ECPSM29T-32.768K
ECS	ECX-306
Fox	FSM-327

Application Section

Battery Backup Details

Note that any input signal conditioning circuitry that is added in regular operation or battery backup should have minimum supply current drain, or have the capability to be put in a low power standby mode. Op Amps such as the EL8176 have low normal supply current (50µA) and standby power drain (3µA), so can be used in battery backup applications.

Oscillator Crystal Requirements

The ISL12020 uses a standard 32.768kHz crystal. Either through hole or surface mount crystals can be used. Table 23 lists some recommended surface mount crystals and the parameters of each. This list is not exhaustive and other surface mount devices can be used with the ISL12020 if their specifications are very similar to the devices listed.

The crystal should have a required parallel load capacitance of 12.5pF and an equivalent series resistance of less than 50k. The crystal's temperature range specification should match the application. Many crystals are rated for -10°C to +60°C (especially through hole and tuning fork types), so an appropriate crystal should be selected if extended temperature range is required.

Layout Considerations

The crystal input at X1 has a very high impedance, and oscillator circuits operating at low frequencies such as 32.768kHz are known to pick up noise very easily if layout precautions are not followed. Most instances of erratic clocking or large accuracy errors can be traced to the susceptibility of the oscillator circuit to interference from adjacent high speed clock or data lines. Careful layout of the RTC circuit will avoid noise pickup and insure accurate clocking.

Figure 11 shows a suggested layout for the ISL12020 device using a surface mount crystal. Two main precautions should be followed:

- Do not run the serial bus lines or any high speed logic lines in the vicinity of the crystal. These logic level lines can induce noise in the oscillator circuit to cause misclocking.
- Add a ground trace around the crystal with one end terminated at the chip ground. This will provide termination for emitted noise in the vicinity of the RTC device.

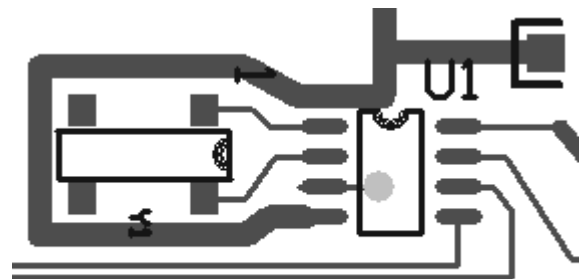

FIGURE 11. SUGGESTED LAYOUT FOR ISL12020 AND CRYSTAL

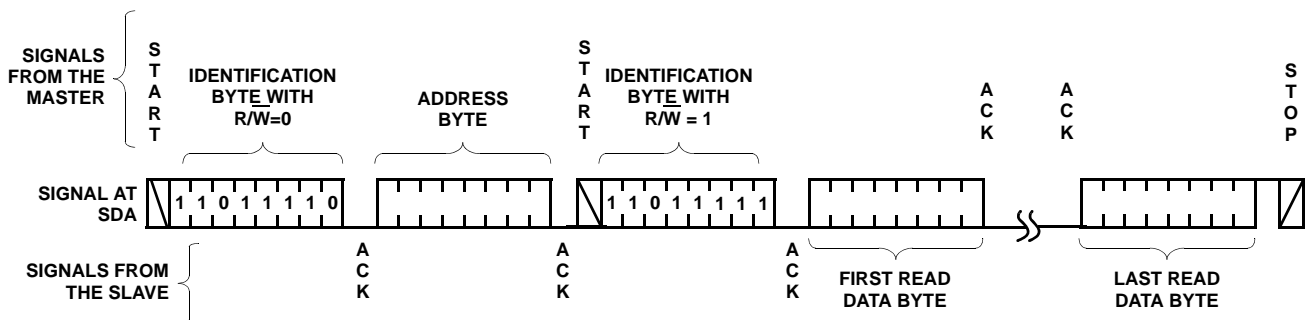

FIGURE 12. READ SEQUENCE (CSR SLAVE ADDRESS SHOWN)

In addition, it is a good idea to avoid a ground plane under the X1 and X2 pins and the crystal, as this will affect the load capacitance and therefore the oscillator accuracy of the circuit. If the \sim IRQ/FOUT pin is used as a clock, it should be routed away from the RTC device as well. The traces for the VBAT and VDD pins can be treated as a ground, and should be routed around the crystal.

Super Capacitor Backup

The ISL12020 device provides a VBAT pin which is used for a battery backup input. A Super Capacitor can be used as an alternative to a battery in cases where shorter backup times are required. Since the battery backup supply current required by the ISL12020 is extremely low, it is possible to get months of backup operation using a Super Capacitor. Typical capacitor values are a few μ F to 1F or more depending on the application.

If backup is only needed for a few minutes, then a small inexpensive electrolytic capacitor can be used. For extended periods, a low leakage, high capacity Super Capacitor is the best choice. These devices are available from such vendors as Panasonic and Murata. The main specifications include working voltage and leakage current. If the application is for charging the capacitor from a +5V \pm 5% supply with a signal diode, then the voltage on the capacitor can vary from \sim 4.5V to slightly over 5.0V. A capacitor with a rated WV of 5.0V may have a reduced lifetime if the supply voltage is slightly high. The leakage current should be as small as possible. For example, a Super Capacitor should be specified with leakage of well below 1 μ A. A standard electrolytic capacitor with DC leakage current in the microamps will have a severely shortened backup time.

Following are some examples with equations to assist with calculating backup times and required capacitance for the ISL12020 device. The backup supply current plays a major part in these equations, and a typical value was chosen for example purposes. For a robust design, a margin of 30% should be included to cover supply current and capacitance tolerances over the results of the calculations. Even more margin should be included if periods of very warm temperature operation are expected.

Example 1. Calculating Backup Time Given Voltages and Capacitor Value

In Figure 13, use $C_{BAT} = 0.47$ F and $V_{DD} = 5.0$ V. With $V_{DD} = 5.0$ V, the voltage at VBAT will approach 4.7V as the diode turns off completely. The ISL12020 is specified to operate down to $V_{BAT} = 1.8$ V. The capacitance charge/discharge equation is used to estimate the total backup time:

$$I = C_{BAT} \cdot dV/dT \quad (\text{EQ. 2})$$

Rearranging gives

$$dT = C_{BAT} \cdot dV/I_{TOT} \text{ to solve for backup time.} \quad (\text{EQ. 3})$$

C_{BAT} is the backup capacitance and dV is the change in voltage from fully charged to loss of operation. Note that I_{TOT} is the total of the supply current of the ISL12020 (I_{BAT}) plus the leakage current of the capacitor and the diode, I_{LKG} . In these calculations, I_{LKG} is assumed to be extremely small and will be ignored. If an application requires extended operation at temperatures over +50°C, these leakages will increase and hence reduce backup time.

Note that I_{BAT} changes with V_{BAT} almost linearly. This allows us to make an approximation of I_{BAT} , using a value midway between the two endpoints. The typical linear equation for I_{BAT} vs V_{BAT} is:

$$I_{BAT} = 1.031E-7 \cdot (V_{BAT}) + 1.036E-7A \quad (\text{EQ. 4})$$

Using this equation to solve for the average current given 2 voltage points gives:

$$I_{BATAVG} = 5.155E-8 \cdot (V_{BAT2} + V_{BAT1}) + 1.036E-7A \quad (\text{EQ. 5})$$

Combining with Equation 3 gives the equation for backup time:

$$t_{BACKUP} = C_{BAT} \cdot (V_{BAT2} - V_{BAT1}) / (I_{BATAVG} + I_{LKG}) \text{ seconds} \quad (\text{EQ. 6})$$

where

$$C_{BAT} = 0.47\text{F}$$

$$V_{BAT2} = 4.7\text{V}$$

$$V_{BAT1} = 1.8\text{V}$$

$$I_{LKG} = 0 \text{ (assumed minimal)}$$

Solving Equation 5 for this example, $I_{BATAVG} = 4.387E-7A$

$$t_{BACKUP} = 0.47 \cdot (2.9) / 4.38E-7 = 3.107E6\text{s}$$

Since there are 86,400 seconds in a day, this corresponds to 35.96 days. If the 30% tolerance is included for capacitor and supply current tolerances, then worst case backup time would be:

$$C_{BAT} = 0.70 \cdot 35.96 = 25.2 \text{ days} \quad (\text{EQ. 7})$$

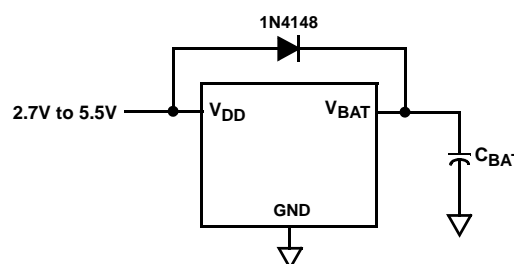

FIGURE 13. SUPERCAPACITOR CHARGING CIRCUIT

Example 2. Calculating a Capacitor Value for a Given Backup Time

Referring to Figure 13 again, the capacitor value needs to be calculated to give 2 months (60 days) of backup time, given $V_{DD} = 5.0V$. As in Example 1, the V_{BAT} voltage will vary from 4.7V down to 1.8V. We will need to rearrange Equation 3 to solve for capacitance:

$$C_{BAT} = dT \cdot I / dV \quad (\text{EQ. 8})$$

Using the terms described above, this equation becomes:

$$C_{BAT} = t_{BACKUP} \cdot (I_{BATAVG} + I_{LKG}) / (V_{BAT2} - V_{BAT1}) \quad (\text{EQ. 9})$$

where

$$t_{BACKUP} = 60 \text{ days} \cdot 86,400 \text{ s/day} = 5.18 \text{ E6s}$$

$$I_{BATAVG} = 4.387 \text{ E-7A (same as Example 1)}$$

$$I_{LKG} = 0 \text{ (assumed)}$$

$$V_{BAT2} = 4.7V$$

$$V_{BAT1} = 1.8V$$

Solving gives

$$C_{BAT} = 5.18 \text{ E6} \cdot (4.387 \text{ E-7}) / (2.9) = 0.784F$$

If the 30% tolerance is included for tolerances, then worst case cap value would be:

$$C_{BAT} = 1.3 \cdot 0.784 = 1.02F$$

EEPW 电子产品世界
www.eepw.com.cn

Small Outline Plastic Packages (SOIC)

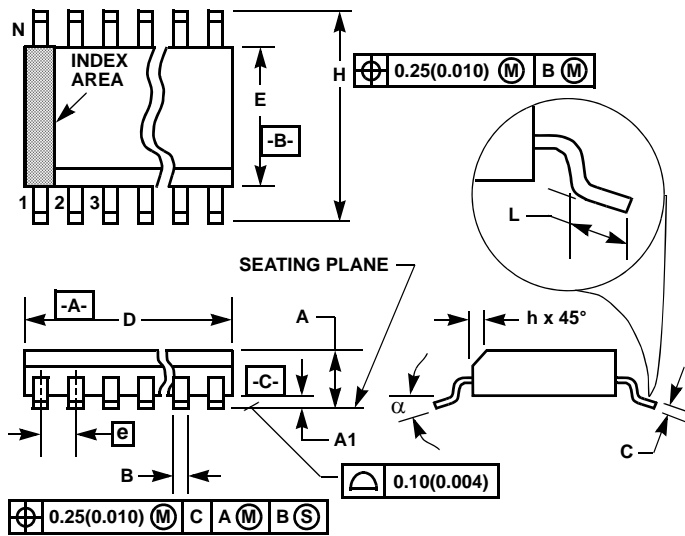

NOTES:

1. Symbols are defined in the "MO Series Symbol List" in Section 2.2 of Publication Number 95.
2. Dimensioning and tolerancing per ANSI Y14.5M-1982.
3. Dimension "D" does not include mold flash, protrusions or gate burrs. Mold flash, protrusion and gate burrs shall not exceed 0.15mm (0.006 inch) per side.
4. Dimension "E" does not include interlead flash or protrusions. Interlead flash and protrusions shall not exceed 0.25mm (0.010 inch) per side.
5. The chamfer on the body is optional. If it is not present, a visual index feature must be located within the crosshatched area.
6. "L" is the length of terminal for soldering to a substrate.
7. "N" is the number of terminal positions.
8. Terminal numbers are shown for reference only.
9. The lead width "B", as measured 0.36mm (0.014 inch) or greater above the seating plane, shall not exceed a maximum value of 0.61mm (0.024 inch).
10. Controlling dimension: MILLIMETER. Converted inch dimensions are not necessarily exact.

M8.15 (JEDEC MS-012-AA ISSUE C) 8 LEAD NARROW BODY SMALL OUTLINE PLASTIC PACKAGE

SYMBOL	INCHES		MILLIMETERS		NOTES
	MIN	MAX	MIN	MAX	
A	0.0532	0.0688	1.35	1.75	-
A1	0.0040	0.0098	0.10	0.25	-
B	0.013	0.020	0.33	0.51	9
C	0.0075	0.0098	0.19	0.25	-
D	0.1890	0.1968	4.80	5.00	3
E	0.1497	0.1574	3.80	4.00	4
e	0.050 BSC		1.27 BSC		-
H	0.2284	0.2440	5.80	6.20	-
h	0.0099	0.0196	0.25	0.50	5
L	0.016	0.050	0.40	1.27	6
N	8		8		7
α	0°	8°	0°	8°	-

Rev. 1 6/05

All Intersil U.S. products are manufactured, assembled and tested utilizing ISO9000 quality systems. Intersil Corporation's quality certifications can be viewed at www.intersil.com/design/quality

Intersil products are sold by description only. Intersil Corporation reserves the right to make changes in circuit design, software and/or specifications at any time without notice. Accordingly, the reader is cautioned to verify that data sheets are current before placing orders. Information furnished by Intersil is believed to be accurate and reliable. However, no responsibility is assumed by Intersil or its subsidiaries for its use; nor for any infringements of patents or other rights of third parties which may result from its use. No license is granted by implication or otherwise under any patent or patent rights of Intersil or its subsidiaries.

For information regarding Intersil Corporation and its products, see www.intersil.com