

HiPerFET™ Power MOSFETs

N-Channel Enhancement Mode
High dv/dt, Low t_{rr} , HDMOS™ Family

	V_{DSS}	I_{D25}	$R_{DS(on)}$	t_{rr}
IXFH8N80	800V	8A	1.1Ω	250 ns
IXFH9N80	800V	9A	0.9Ω	250 ns

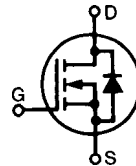

Symbol	Test Conditions	Maximum Ratings	
V_{DSS}	$T_J = 25^\circ\text{C}$ to 150°C	800	V
V_{DGR}	$T_J = 25^\circ\text{C}$ to 150°C ; $R_{GS} = 1\text{ M}\Omega$	800	V
V_{GS}	Continuous	± 20	V
V_{GSM}	Transient	± 30	V
I_{D25}	$T_C = 25^\circ\text{C}$	8N80	8 A
		9N80	9 A
I_{DM}	$T_C = 25^\circ\text{C}$, pulse width limited by T_{JM}	8N80	32 A
		9N80	36 A
I_{AR}	$T_C = 25^\circ\text{C}$	8N80	8 A
		9N80	9 A
E_{AR}	$T_C = 25^\circ\text{C}$	18	mJ
dv/dt	$I_S \leq I_{DM}$, $di/dt \leq 100\text{ A}/\mu\text{s}$, $V_{DD} \leq V_{DSS}$, $T_J \leq 150^\circ\text{C}$, $R_G = 2\ \Omega$	5	V/ns
P_D	$T_C = 25^\circ\text{C}$	180	W
T_J		-55 ... +150	$^\circ\text{C}$
T_{JM}		150	$^\circ\text{C}$
T_{stg}		-55 ... +150	$^\circ\text{C}$
M_d	Mounting torque	1.13/10 Nm/lb.in.	
Weight		TO-204 = 18 g, TO-247 = 6 g	
Maximum lead temperature for soldering 1.6 mm (0.062 in.) from case for 10 s		300	$^\circ\text{C}$

TO-247 AD (IXFH)

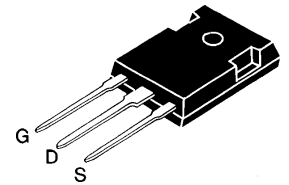

TO-247 SMD*

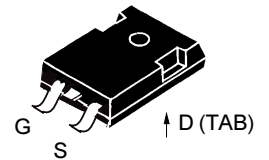

G = Gate D = Drain
S = Source TAB = Drain

*Add suffix letter "S" for surface mountable package

Features

- International standard packages
- Low $R_{DS(on)}$ HDMOS™ process
- Rugged polysilicon gate cell structure
- Unclamped Inductive Switching (UIS) rated
- Low package inductance
- easy to drive and to protect
- Fast intrinsic Rectifier

Applications

- DC-DC converters
- Battery chargers
- Switched-mode and resonant-mode power supplies
- DC choppers
- AC motor control
- Temperature and lighting controls

Advantages

- Easy to mount with 1 screw (TO-247) (isolated mounting screw hole)
- Space savings
- High power density

Symbol	Test Conditions	Characteristic Values ($T_J = 25^\circ\text{C}$, unless otherwise specified)		
		min.	typ.	max.
V_{DSS}	$V_{GS} = 0\text{ V}$, $I_D = 3\text{ mA}$	800		V
	V_{DSS} temperature coefficient		0.088	%/K
$V_{GS(th)}$	$V_{DS} = V_{GS}$, $I_D = 2.5\text{ mA}$	2		4.5 V
	$V_{GS(th)}$ temperature coefficient		-0.257	%/K
I_{GSS}	$V_{GS} = \pm 20\text{ V}_{DC}$, $V_{DS} = 0$			$\pm 100\text{ nA}$
I_{DSS}	$V_{DS} = 0.8 \cdot V_{DSS}$, $V_{GS} = 0\text{ V}$			250 μA
	$T_J = 25^\circ\text{C}$ $T_J = 125^\circ\text{C}$			1 mA
$R_{DS(on)}$	$V_{GS} = 10\text{ V}$, $I_D = 0.5 \cdot I_{D25}$	8N80		1.1 Ω
	Pulse test, $t \leq 300\ \mu\text{s}$, duty cycle $\delta \leq 2\%$	9N80		0.9 Ω

Symbol	Test Conditions	Characteristic Values ($T_J = 25^\circ\text{C}$, unless otherwise specified)		
		min.	typ.	max.
g_{fs}	$V_{DS} = 10\text{ V}; I_D = 0.5 \cdot I_{D25}$, pulse test	4	7	S
C_{iss}	$V_{GS} = 0\text{ V}, V_{DS} = 25\text{ V}, f = 1\text{ MHz}$		2600	pF
C_{oss}			240	pF
C_{rss}			60	pF
$t_{d(on)}$	$V_{GS} = 10\text{ V}, V_{DS} = 0.5 \cdot V_{DSS}, I_D = 0.5 \cdot I_{D25}$ $R_G = 4.7\ \Omega$ (External)		35	ns
t_r			15	ns
$t_{d(off)}$			70	ns
t_f			35	ns
$Q_{g(on)}$	$V_{GS} = 10\text{ V}, V_{DS} = 0.5 \cdot V_{DSS}, I_D = 0.5 \cdot I_{D25}$		85	130 nC
Q_{gs}			15	30 nC
Q_{gd}			40	70 nC
R_{thJC}			0.7	K/W
R_{thCK}			0.25	K/W

TO-247 AD (IXFH) Outline

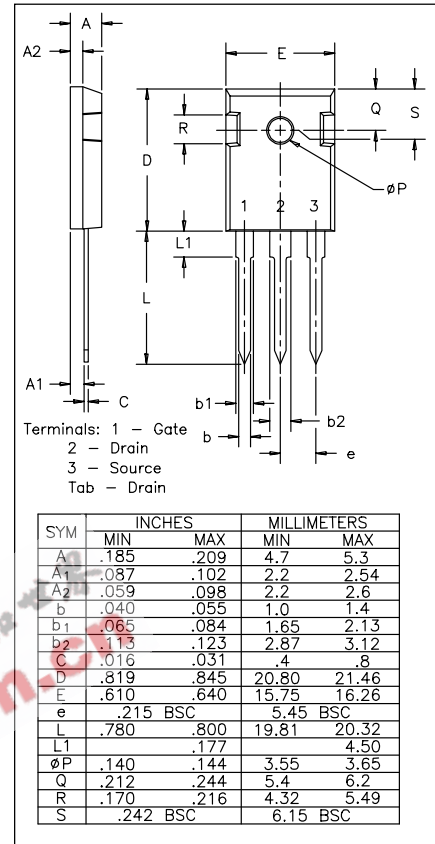

Source-Drain Diode

Symbol	Test Conditions	Characteristic Values ($T_J = 25^\circ\text{C}$, unless otherwise specified)		
		min.	typ.	max.
I_S	$V_{GS} = 0$	8N80 9N80		8 A 9 A
I_{SM}	Repetitive; pulse width limited by T_{JM}	8N80 9N80		32 A 36 A
V_{SD}	$I_F = I_S, V_{GS} = 0\text{ V}$, Pulse test, $t \leq 300\ \mu\text{s}$, duty cycle $\delta \leq 2\%$			1.5 V
t_{rr}	$I_F = I_S$ $-di/dt = 100\text{ A}/\mu\text{s}$, $V_R = 100\text{ V}$	$T_J = 25^\circ\text{C}$		250 ns
		$T_J = 125^\circ\text{C}$		400 ns
Q_{RM}	$I_F = I_S$ $-di/dt = 100\text{ A}/\mu\text{s}$, $V_R = 100\text{ V}$	$T_J = 25^\circ\text{C}$	0.5	μC
		$T_J = 125^\circ\text{C}$	1.0	μC
I_{RM}	$I_F = I_S$ $-di/dt = 100\text{ A}/\mu\text{s}$, $V_R = 100\text{ V}$	$T_J = 25^\circ\text{C}$	7.5	A
		$T_J = 125^\circ\text{C}$	9.0	A

TO-247 SMD Outline

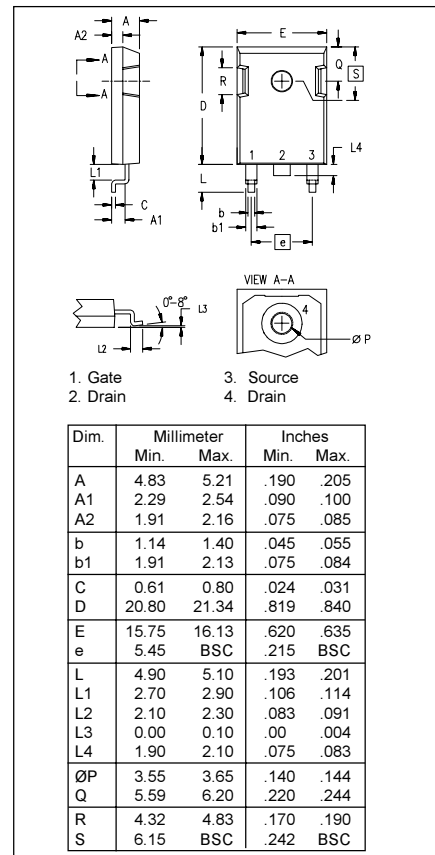

IXYS reserves the right to change limits, test conditions, and dimensions.

IXYS MOSFETS and IGBTs are covered by one or more of the following U.S. patents: 4,835,592 4,881,106 5,017,508 5,049,961 5,187,117 5,486,715
4,850,072 4,931,844 5,034,796 5,063,307 5,237,481 5,381,025

Figure 1. Output Characteristics at 25°C

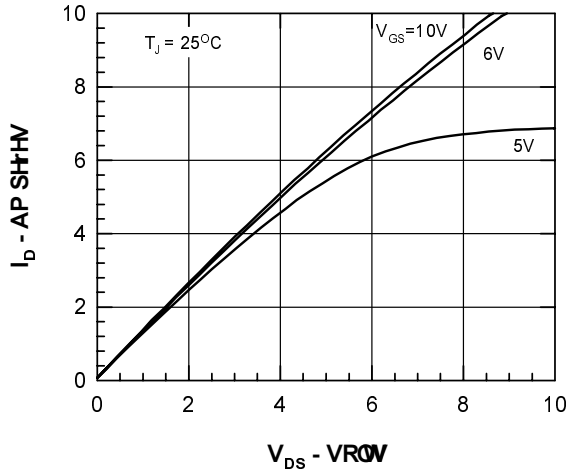

Figure 2. Output Characteristics at 125°C

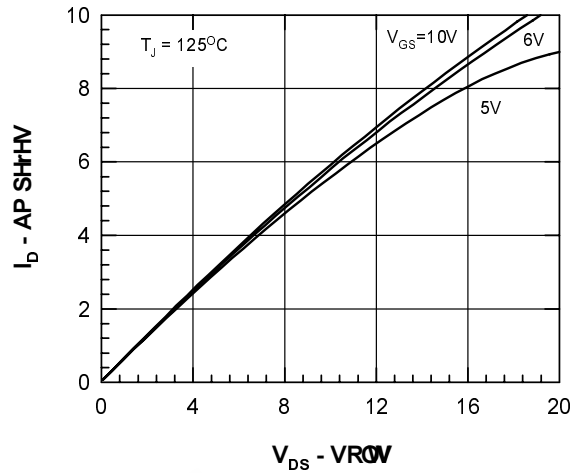

Figure 3. $R_{DS(on)}$ normalized to 15A/25°C vs. I_D

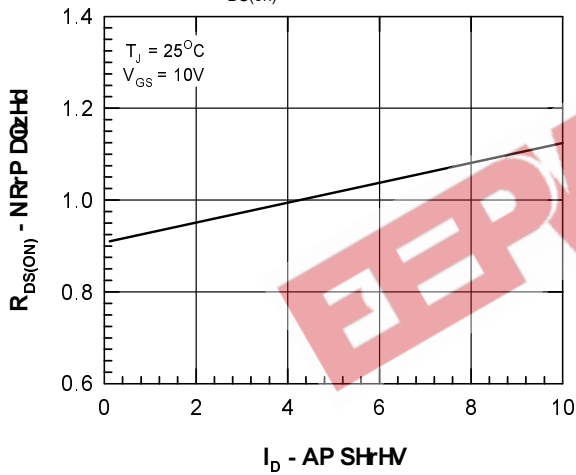

Figure 4. $R_{DS(on)}$ normalized to 15A/25°C vs. T_J

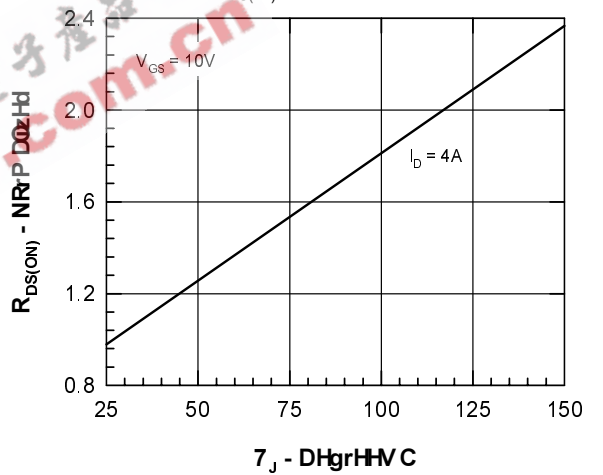

Figure 5. Drain Current vs. Case Temperature

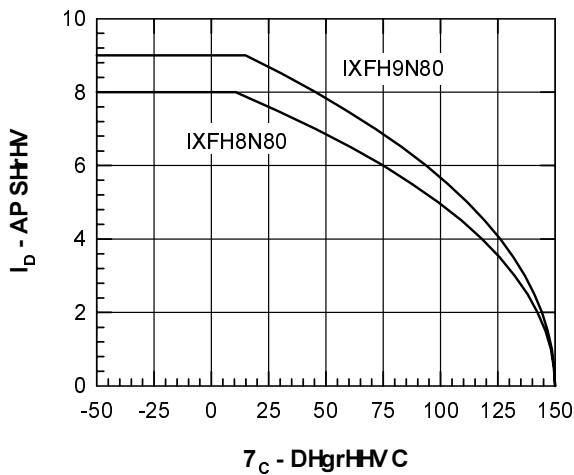

Figure 6. Admittance Curves

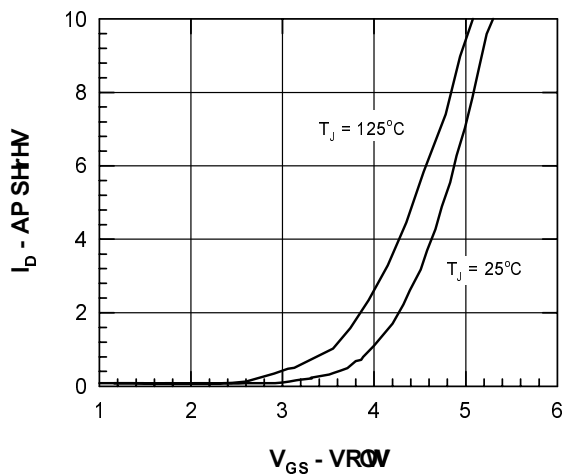

Figure 7. Gate Charge

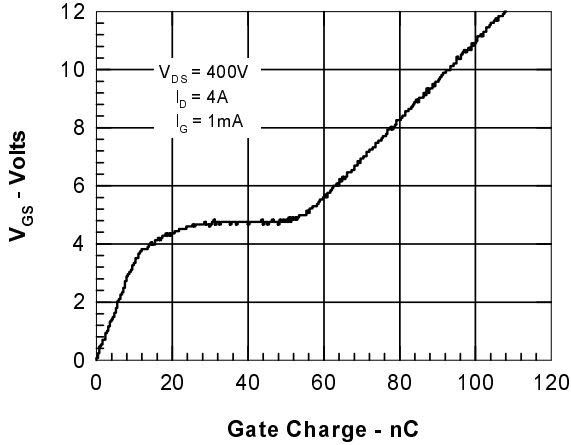

Figure 8. Capacitance Curves

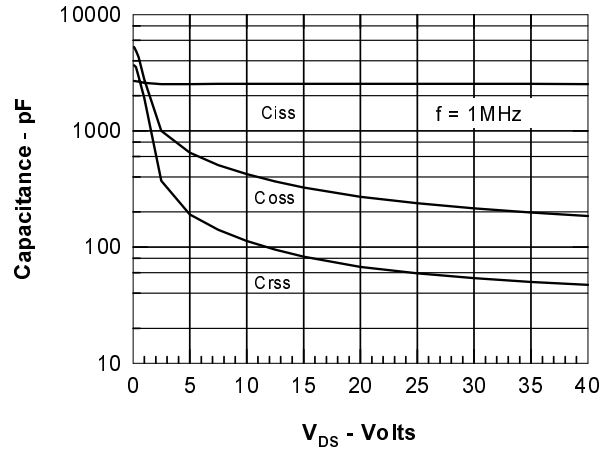

Figure 9. Forward Voltage Drop of the Intrinsic Diode

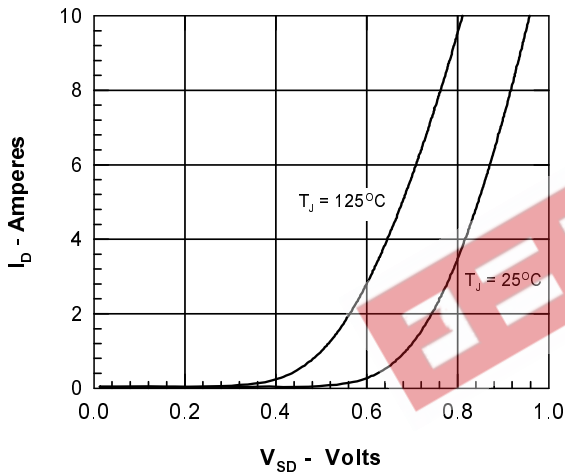

Figure 10. Forward Bias Safe Operating Area

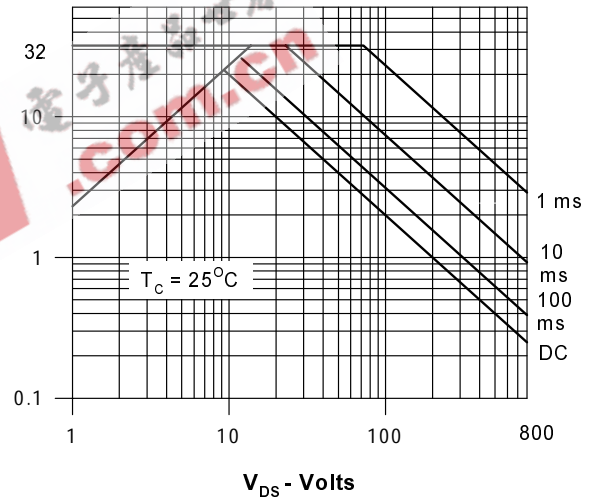
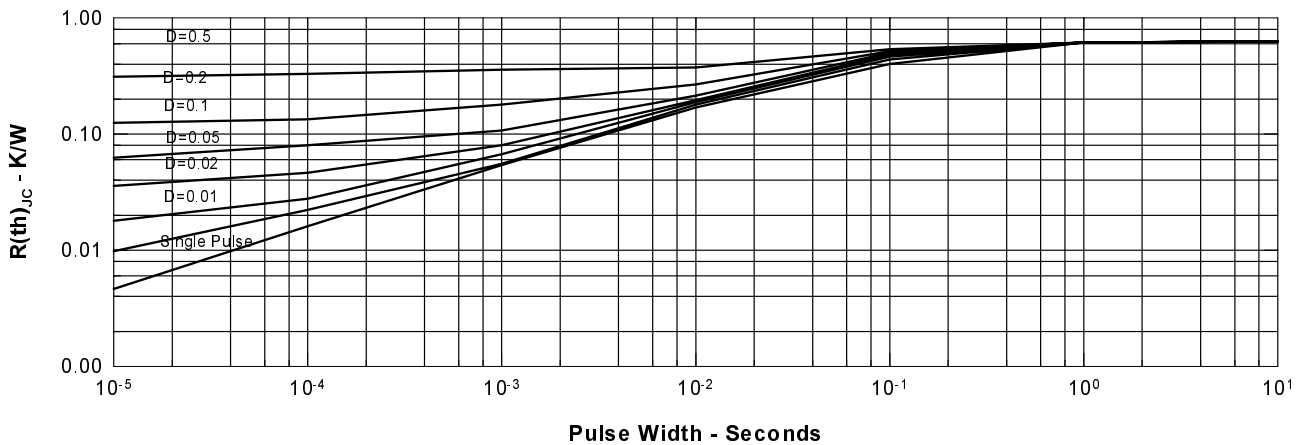

Figure 11. Transient Thermal Resistance



IXYS reserves the right to change limits, test conditions, and dimensions.

IXYS MOSFETS and IGBTs are covered by one or more of the following U.S. patents:

4,835,592	4,881,106	5,017,508	5,049,961	5,187,117	5,486,715
4,850,072	4,931,844	5,034,796	5,063,307	5,237,481	5,381,025