

12V, 7MHz, CMOS, Rail-to-Rail I/O OPERATIONAL AMPLIFIERS

FEATURES

- **HIGH SPEED:** 7MHz, 10V/ μ s
- **RAIL-TO-RAIL INPUT AND OUTPUT**
- **WIDE SUPPLY RANGE:**
Single Supply: 3.5V to 12V
Dual Supplies: ± 1.75 V to ± 6 V
- **LOW QUIESCENT CURRENT:** 1.1mA
- **FULL-SCALE CMRR:** 84dB
- **MicroSIZE PACKAGES:**
SOT23-5, MSOP-8, TSSOP-14
- **LOW INPUT BIAS CURRENT:** 1pA

APPLICATIONS

- **LCD GAMMA CORRECTION**
- **AUTOMOTIVE APPLICATIONS:**
Audio, Sensor Applications, Security Systems
- **PORTABLE EQUIPMENT**
- **ACTIVE FILTERS**
- **TRANSDUCER AMPLIFIER**
- **TEST EQUIPMENT**
- **DATA ACQUISITION**

DESCRIPTION

The OPA743 series utilizes a state-of-the-art 12V analog CMOS process and offers outstanding AC performance, such as 7MHz GBW, 10V/ μ s slew rate and 0.0008% THD+N. Optimized for single supply operation up to 12V, the input common-mode range extends beyond the power supply rails and the output swings to within 100mV of the rails. The low quiescent current of 1.1mA makes it well suited for use in battery operated equipment.

The OPA743 series' ability to drive high output currents together with 12V operation makes it particularly useful for use as gamma correction reference buffer in LCD panels.

For ease of use the OPA743 op-amp family is fully specified and tested over the supply range of ± 1.75 V to ± 6 V. Single, dual and quad versions are available.

The single versions (OPA743) are available in the *MicroSIZE* SOT23-5 and in the standard SO-8 surface-mount, as well as DIP-8 packages. Dual versions (OPA2743) are available versions in the MSOP-8, SO-8, and DIP-8 packages. The quad versions (OPA4743) are available in the TSSOP-14 and SO-14 packages. All are specified for operation from -40° C to $+85^{\circ}$ C.

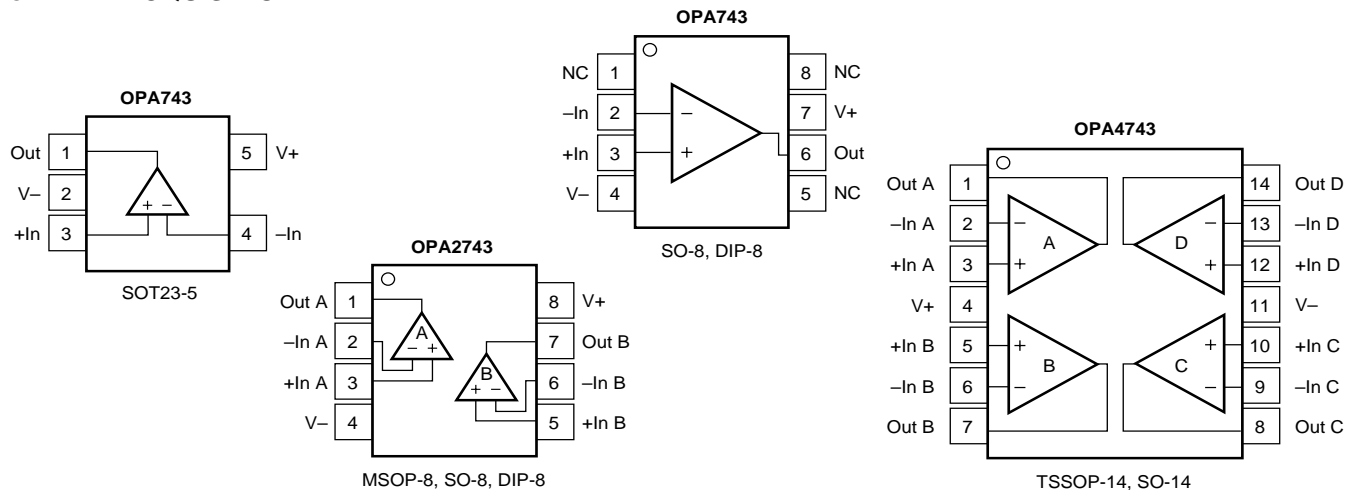

Please be aware that an important notice concerning availability, standard warranty, and use in critical applications of Texas Instruments semiconductor products and disclaimers thereto appears at the end of this data sheet.

ABSOLUTE MAXIMUM RATINGS⁽¹⁾

Supply Voltage, V+ to V-.....	13.2V
Signal Input Terminals, Voltage ⁽²⁾	(V-) -0.3V to (V+) +0.3V
Current ⁽²⁾	10mA
Output Short-Circuit ⁽³⁾	Continuous
Operating Temperature.....	-55°C to +125°C
Storage Temperature.....	-65°C to +150°C
Junction Temperature.....	+150°C
Lead Temperature (soldering, 10s).....	+300°C

NOTES: (1) Stresses above these ratings may cause permanent damage. Exposure to absolute maximum conditions for extended periods may degrade device reliability. (2) Input terminals are diode-clamped to the power supply rails. Input signals that can swing more than 0.3V beyond the supply rails should be current-limited to 10mA or less. (3) Short-circuit to ground, one amplifier per package.



ELECTROSTATIC DISCHARGE SENSITIVITY

This integrated circuit can be damaged by ESD. Texas Instruments recommends that all integrated circuits be handled with appropriate precautions. Failure to observe proper handling and installation procedures can cause damage.

ESD damage can range from subtle performance degradation to complete device failure. Precision integrated circuits may be more susceptible to damage because very small parametric changes could cause the device not to meet its published specifications.

PACKAGE/ORDERING INFORMATION

PRODUCT	PACKAGE	PACKAGE DRAWING NUMBER	PACKAGE MARKING	ORDERING NUMBER ⁽¹⁾	TRANSPORT MEDIA
Single					
OPA743NA	SOT23-5	331	D43	OPA743NA/250	Tape and Reel
"	"	"	"	OPA743NA/3K	Tape and Reel
OPA743UA	SO-8	182	OPA743UA	OPA743UA	Rails
"	"	"	"	OPA743UA/2K5	Tape and Reel
OPA743PA	DIP-8	006	OPA743PA	OPA743PA	Rails
Dual					
OPA2743EA	MSOP-8	337	E43	OPA2743EA/250	Tape and Reel
"	"	"	"	OPA2743EA/2K5	Tape and Reel
OPA2743UA	SO-8	182	OPA2743UA	OPA2743UA	Rails
"	"	"	"	OPA2743UA/2K5	Tape and Reel
OPA2743PA	DIP-8	006	OPA2743PA	OPA2743PA	Rails
Quad					
OPA4743EA	TSSOP-14	357	OPA4743EA	OPA4743EA/250	Tape and Reel
"	"	"	"	OPA4743EA/2K5	Tape and Reel
OPA4743UA	SO-14	235	OPA4743UA	OPA4743UA	Rails
"	"	"	"	OPA4743UA/2K5	Tape and Reel

NOTE: (1) Models with a slash (/) are available only in Tape and Reel in the quantities indicated (e.g., /3K indicates 3000 devices per reel). Ordering 3000 pieces of "OPA743NA/3K" will get a single 3000-piece Tape and Reel.

ELECTRICAL CHARACTERISTICS: $V_S = 3.5V$ to $12V$

Boldface limits apply over the specified temperature range, $T_A = -40^{\circ}C$ to $+85^{\circ}C$

At $T_A = +25^{\circ}C$, $R_L = 10k\Omega$ connected to $V_S/2$ and $V_{OUT} = V_S/2$, unless otherwise noted.

PARAMETER	CONDITION	OPA743NA, UA, PA OPA2743EA, UA, PA OPA4743EA, UA			UNITS
		MIN	TYP	MAX	
OFFSET VOLTAGE Input Offset Voltage Drift vs Power Supply Over Temperature Channel Separation, dc $f = 10kHz$	V_{OS} dV_{OS}/dT PSRR $V_S = \pm 5V, V_{CM} = 0V$ $T_A = -40^{\circ}C$ to $+85^{\circ}C$ $V_S = \pm 1.75V$ to $\pm 6V, V_{CM} = -0.25$ $V_S = \pm 1.75V$ to $\pm 6V, V_{CM} = -0.25$		± 1.5 ± 8 10 1 110	± 7 100 200	mV $\mu V/^{\circ}C$ $\mu V/V$ $\mu V/V$ dB
INPUT VOLTAGE RANGE Common-Mode Voltage Range Common-Mode Rejection Ratio over Temperature over Temperature	V_{CM} CMRR $V_S = \pm 5V, (V-) - 0.1V < V_{CM} < (V+) + 0.1V$ $V_S = \pm 5V, (V-) < V_{CM} < (V+)$ $V_S = \pm 5V, (V-) - 0.1V < V_{CM} < (V+) - 2V$ $V_S = \pm 5V, (V-) < V_{CM} < (V+) - 2V$ $V_S = \pm 1.75V, (V-) - 0.1V < V_{CM} < (V+) + 0.1V$	$(V-) - 0.1$ 66 60 70 70 60	84 90	$(V+) + 0.1$ 	V dB dB dB dB
INPUT BIAS CURRENT Input Bias Current Input Offset Current	I_B I_{OS} $V_S = \pm 6V, V_{CM} = 0V$ $V_S = \pm 6V, V_{CM} = 0V$		± 1 ± 0.5	± 10 ± 10	pA pA
INPUT IMPEDANCE Differential Common-Mode			$4 \cdot 10^9 \parallel 4$ $5 \cdot 10^{12} \parallel 4$		$\Omega \parallel pF$ $\Omega \parallel pF$
NOISE Input Voltage Noise, $f = 0.1Hz$ to $10Hz$ Input Voltage Noise Density, $f = 10kHz$ Current Noise Density, $f = 1kHz$	e_n i_n $V_S = \pm 6V, V_{CM} = 0V$ $V_S = \pm 6V, V_{CM} = 0V$ $V_S = \pm 6V, V_{CM} = 0V$		11 30 2.5		$\mu Vp-p$ nV/\sqrt{Hz} fA/\sqrt{Hz}
OPEN-LOOP GAIN Open-Loop Voltage Gain over Temperature over Temperature	A_{OL} $R_L = 100k\Omega, (V-)+0.1V < V_O < (V+)-0.1V$ $R_L = 100k\Omega, (V-)+0.125V < V_O < (V+)-0.125V$ $R_L = 1k, (V-)+0.325V < V_O < (V+)-0.325V$ $R_L = 1k, (V-)+0.450V < V_O < (V+)-0.450V$	106 100 86 96	120 100		dB dB dB dB
OUTPUT Voltage Output Swing from Rail over Temperature over Temperature Output Current Short-Circuit Current Capacitive Load Drive	I_{OUT} I_{SC} C_{LOAD} $R_L = 100k\Omega, A_{OL} > 106dB$ $R_L = 100k\Omega, A_{OL} > 100dB$ $R_L = 1k\Omega, A_{OL} > 86dB$ $R_L = 1k\Omega, A_{OL} > 96dB$ $ V_S - V_{OUT} < 1V$		75 100 300 425 ± 20 ± 30	100 125 325 450	mV mV mV mV mA mA
FREQUENCY RESPONSE Gain-Bandwidth Product Slew Rate Settling Time, 0.1% 0.01% Overload Recovery Time Total Harmonic Distortion + Noise	GBW SR t_s t_s THD+N $C_L = 15pF$ $G = +1$ $V_S = \pm 6V, G = +1$ $V_S = \pm 6V, 5V$ Step, $G = +1$ $V_S = \pm 6V, 5V$ Step, $G = +1$ $V_{IN} \cdot \text{Gain} = V_S$ $V_S = \pm 6V, V_O = 1V_{rms}, G = +1, f = 6kHz$		7 10 9 15 200 0.0008		MHz $V/\mu s$ μs μs ns %
POWER SUPPLY Specified Voltage Range, Single Supply Specified Voltage Range, Dual Supplies Quiescent Current (per amplifier) over Temperature	V_S V_S I_Q $I_Q = 0$	3.5 ± 1.75	1.1	12 ± 6 1.5 1.7	V V mA mA
TEMPERATURE RANGE Specified Range Operating Range Storage Range Thermal Resistance SOT23-5 Surface-Mount MSOP-8 Surface-Mount TSSOP-14 Surface-Mount SO-8 Surface Mount SO-14 Surface Mount DIP-8	θ_{JA}	-40 -55 -65		85 125 150	$^{\circ}C$ $^{\circ}C$ $^{\circ}C$ $^{\circ}C/W$ $^{\circ}C/W$ $^{\circ}C/W$ $^{\circ}C/W$ $^{\circ}C/W$ $^{\circ}C/W$

TYPICAL CHARACTERISTICS

At $T_A = +25^\circ\text{C}$, $V_S = \pm 6\text{V}$, and $R_L = 10\text{k}\Omega$, unless otherwise noted.

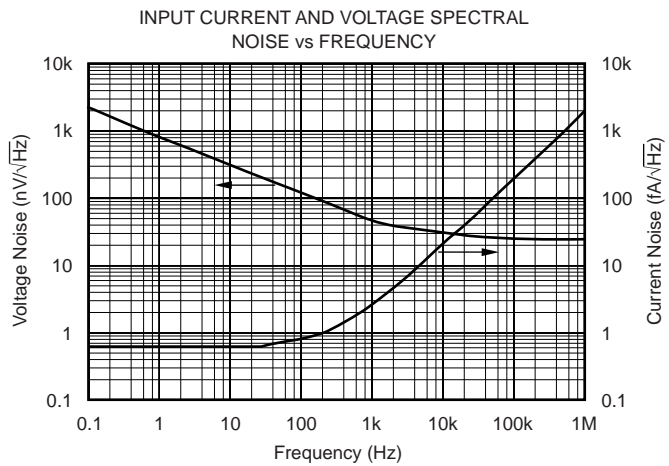
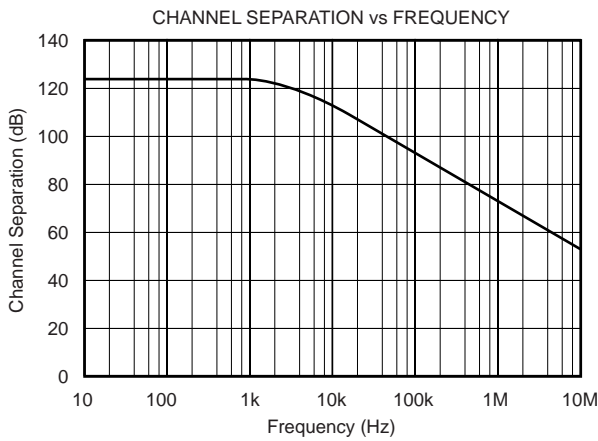
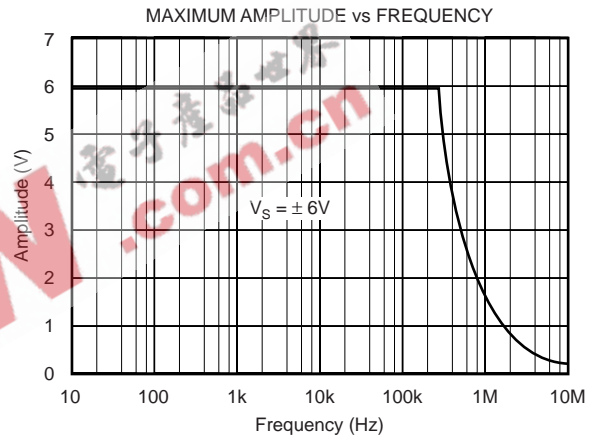
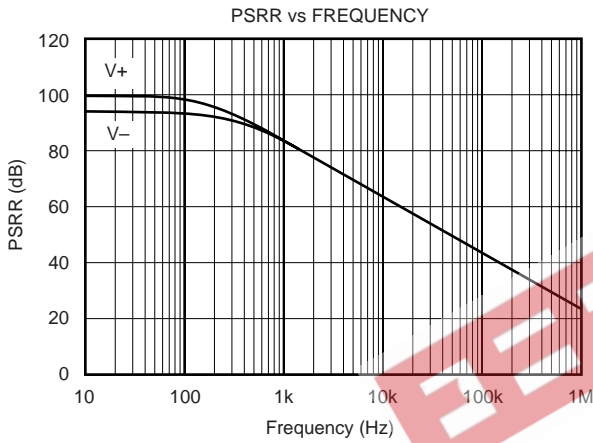
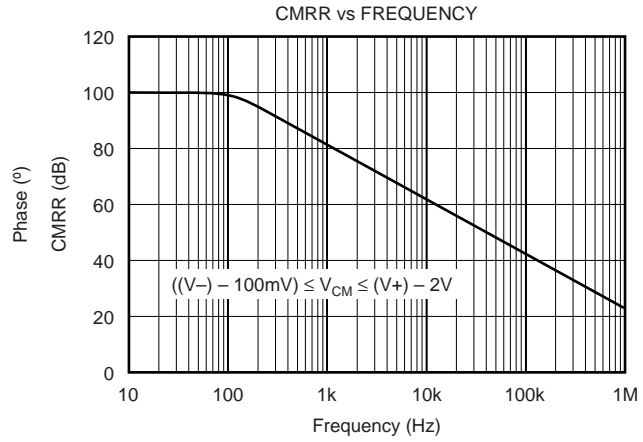
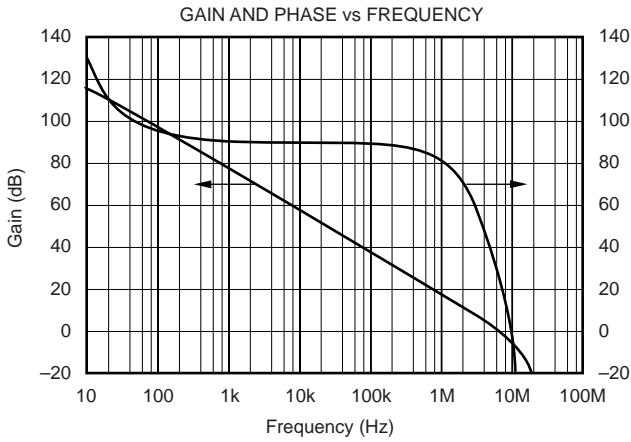

TYPICAL CHARACTERISTICS (Cont.)

At $T_A = +25^\circ\text{C}$, $V_S = \pm 5\text{V}$, and $R_L = 10\text{k}\Omega$, unless otherwise noted.

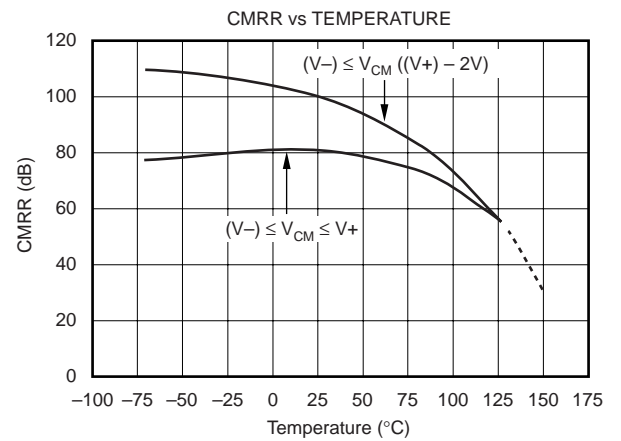
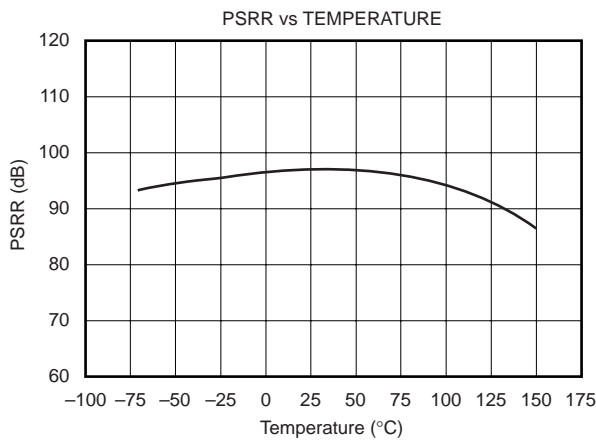
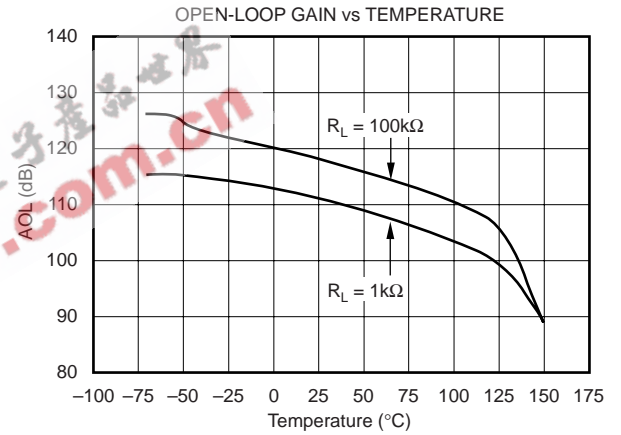
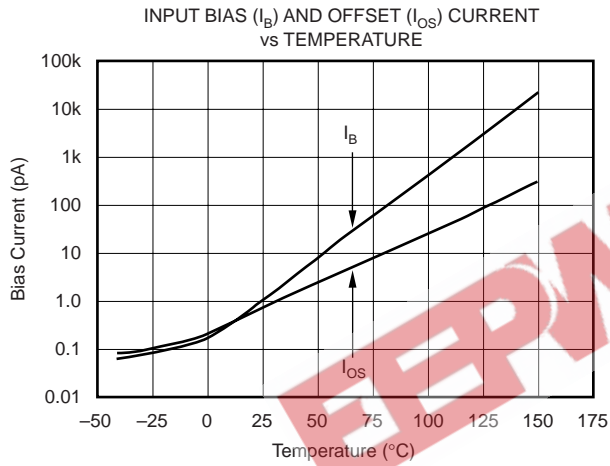
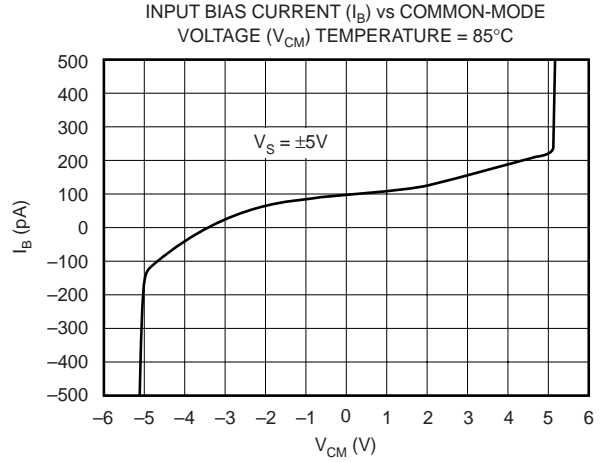
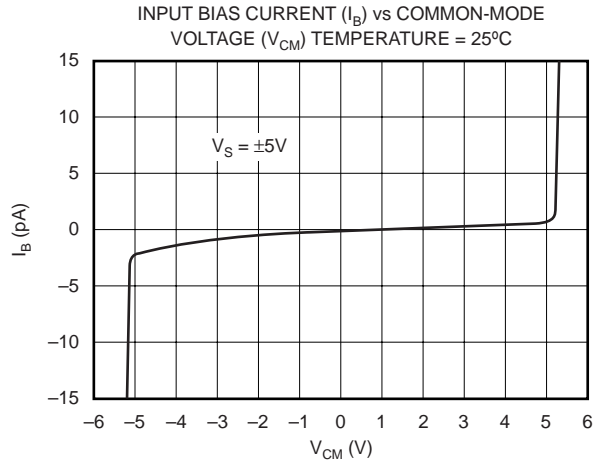

TYPICAL CHARACTERISTICS (Cont.)

At $T_A = +25^\circ\text{C}$, $V_S = \pm 6\text{V}$, and $R_L = 10\text{k}\Omega$, unless otherwise noted.

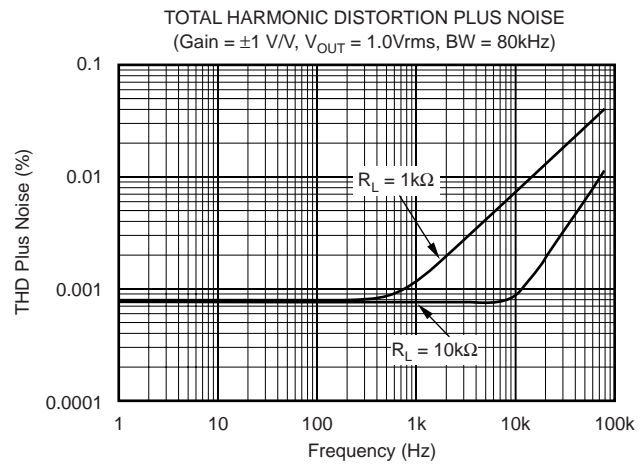
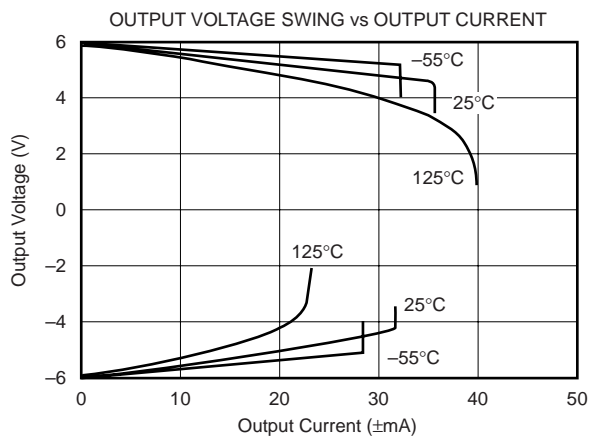
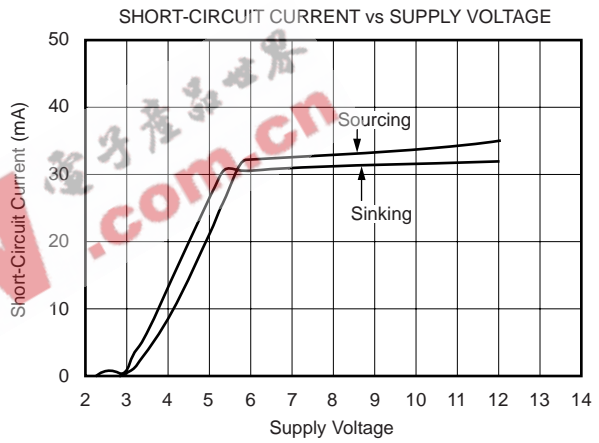
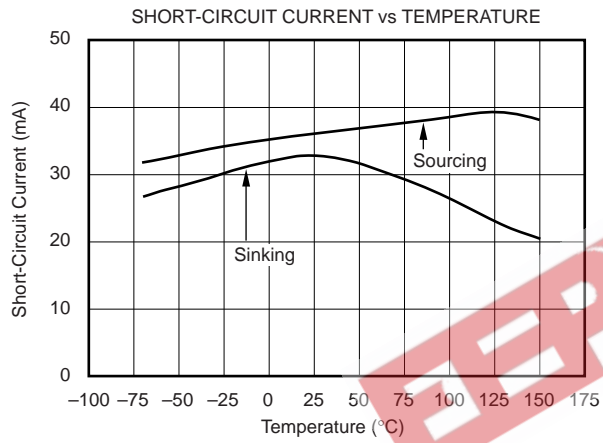
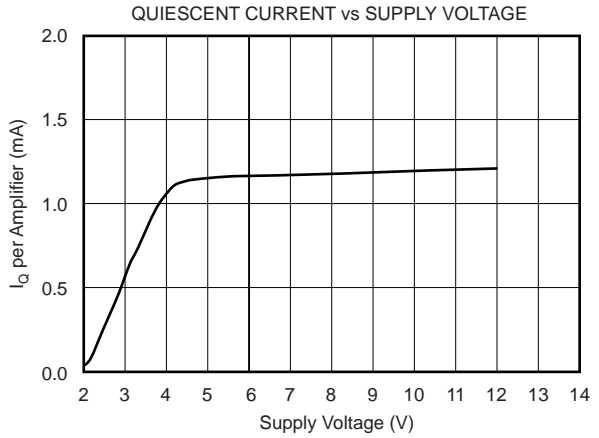
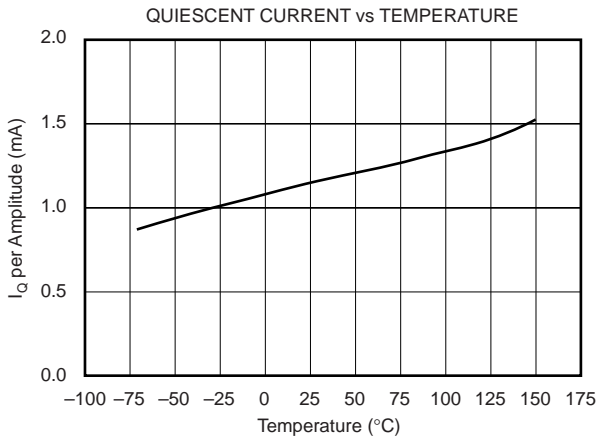

TYPICAL CHARACTERISTICS (Cont.)

At $T_A = +25^\circ\text{C}$, $V_S = \pm 6\text{V}$, and $R_L = 10\text{k}\Omega$, unless otherwise noted.

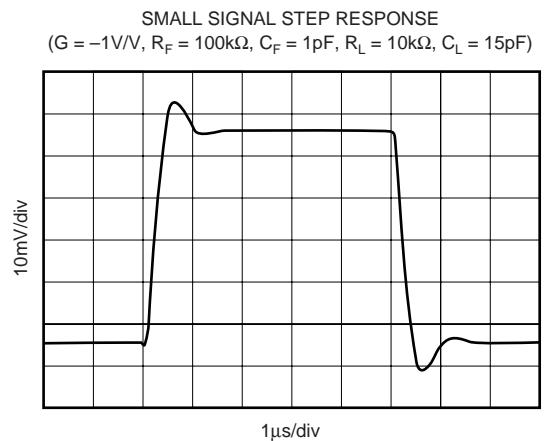
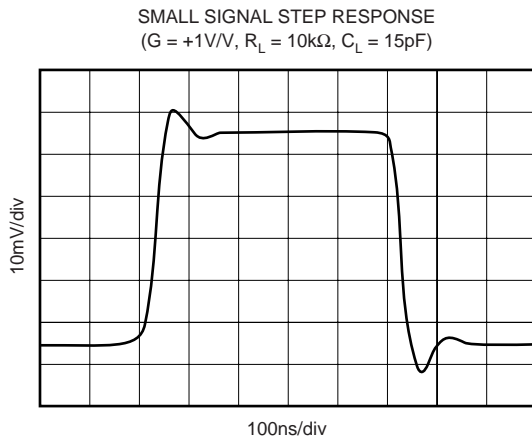
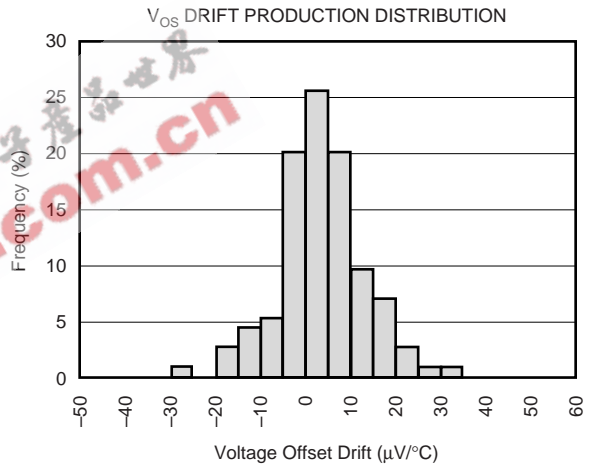
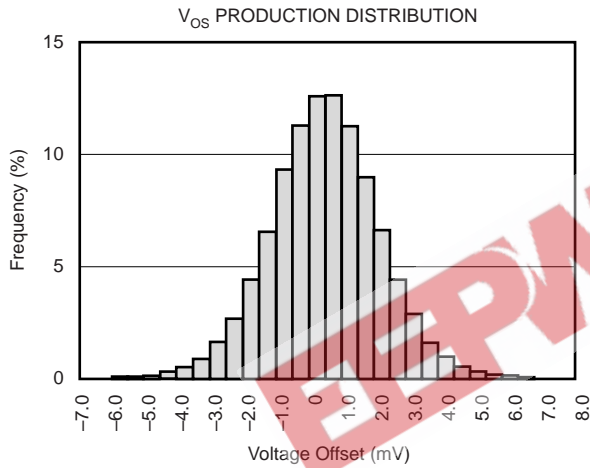
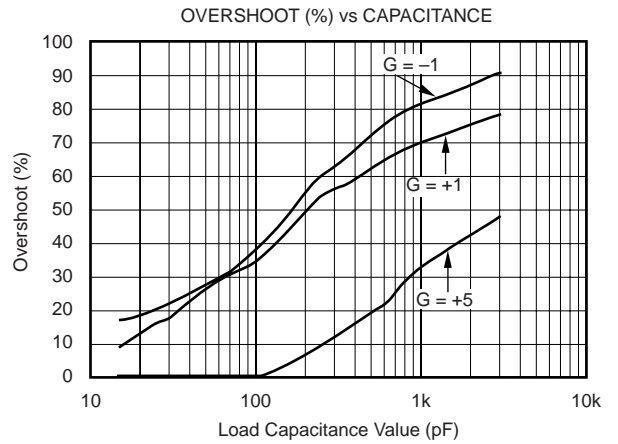
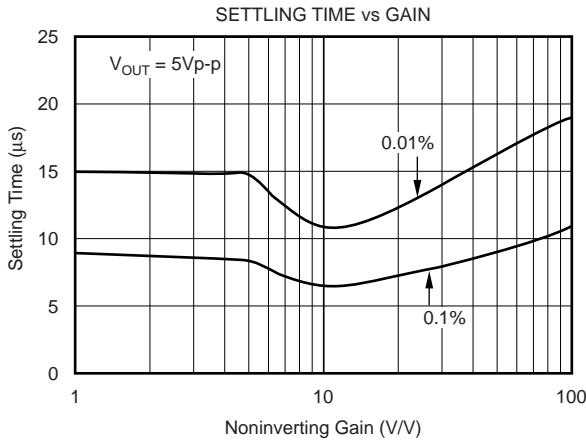

NOTE: C_F is used to optimize settling time.

TYPICAL CHARACTERISTICS (Cont.)

At $T_A = +25^\circ\text{C}$, $V_S = \pm 6\text{V}$, and $R_L = 10\text{k}\Omega$, unless otherwise noted.

LARGE SIGNAL STEP RESPONSE
($G = +1\text{V/V}$, $R_L = 10\text{k}\Omega$, $C_L = 15\text{pF}$)



LARGE SIGNAL STEP RESPONSE
($G = -1\text{V/V}$, $R_L = 10\text{k}\Omega$, $C_L = 15\text{pF}$)



EEPW 电子产品世界 .com.cn

APPLICATIONS INFORMATION

OPA743 series op amps can operate on 1.1mA quiescent current from a single (or split) supply in the range of 3.5V to 12V ($\pm 1.75\text{V}$ to $\pm 6\text{V}$), making them highly versatile and easy to use. The OPA743 is unity-gain stable and offers 7MHz bandwidth and $10\text{V}/\mu\text{s}$ slew rate.

Rail-to-rail input and output swing helps maintain dynamic range, especially in low supply applications. Figure 1 shows the input and output waveforms for the OPA743 in unity-gain configuration. On a $\pm 6\text{V}$ supply with a $100\text{k}\Omega$ load connected to $V_S/2$. The output is tested to swing within 100mV to the rail.

Power-supply pins should be bypassed with 1000pF ceramic capacitors in parallel with $1\mu\text{F}$ tantalum capacitors.

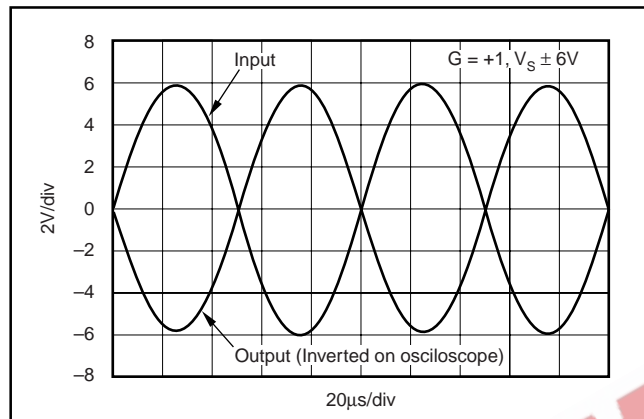

FIGURE 1. Rail-to-Rail Input and Output.

OPERATING VOLTAGE

OPA743 series op amps are fully specified and guaranteed from 3.5V to 12V over a temperature range of -40°C to $+85^\circ\text{C}$. Parameters that vary significantly with operating voltages or temperature are shown in the Typical Characteristics.

RAIL-TO-RAIL INPUT

The input common-mode voltage range of the OPA743 series extends 100mV beyond the supply rails at room temperature. This is achieved with a complementary input stage—an N-channel input differential pair in parallel with a P-channel differential pair. The N-channel pair is active for input voltages close to the positive rail, typically $(V_+) - 2.0\text{V}$ to 100mV above the positive supply, while the P-channel pair is on for inputs from 100mV below the negative supply to approximately $(V_+) - 1.5\text{V}$. There is a small transition region, typically $(V_+) - 2.0\text{V}$ to $(V_+) - 1.5\text{V}$, in which both pairs are on. This 500mV transition region can vary $\pm 100\text{mV}$ with process variation. Thus, the transition region (both stages on) can range from $(V_+) - 2.1\text{V}$ to $(V_+) - 1.4\text{V}$ on the low end, up to $(V_+) - 1.9\text{V}$ to $(V_+) - 1.6\text{V}$ on the high end. Most rail-to-rail op amps on the market use this two input stage approach, and exhibit a transition region where CMRR, offset voltage, and THD may vary compared to operation outside this region.

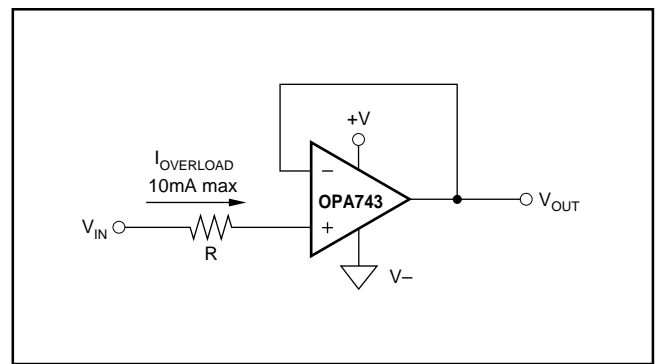

FIGURE 2. Input Current Protection for Voltages Exceeding the Supply Voltage.

INPUT VOLTAGE

Device inputs are protected by ESD diodes that will conduct if the input voltages exceed the power supplies by more than approximately 300mV . Momentary voltages greater than 300mV beyond the power supply can be tolerated if the current is limited to 10mA . This is easily accomplished with an input resistor, in series with the op amp input as shown in Figure 2. Many input signals are inherently current-limited to less than 10mA ; therefore, a limiting resistor is not always required. The OPA743 features no phase inversion when the inputs extend beyond supplies if the input current is limited, as seen in Figure 3.

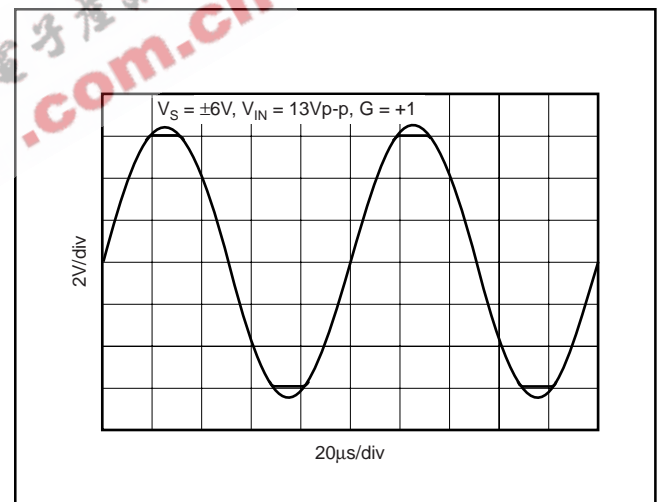

FIGURE 3. OPA743—No Phase Inversion with Inputs Greater than the Power-Supply Voltage.

RAIL-TO-RAIL OUTPUT

A class AB output stage with common-source transistors is used to achieve rail-to-rail output. This output stage is capable of driving $1\text{k}\Omega$ loads connected to any point between V_+ and V_- . For light resistive loads ($> 100\text{k}\Omega$), the output voltage can swing to 100mV from the supply rail. With $1\text{k}\Omega$ resistive loads, the output can swing to within 325mV from the supply rails while maintaining high open-loop gain (see the typical performance curve “Output Voltage Swing vs Output Current”).

CAPACITIVE LOAD AND STABILITY

The OPA743 series op amps can drive up to 1000pF pure capacitive load. Increasing the gain enhances the amplifier's ability to drive greater capacitive loads (see the typical performance curve "Small Signal Overshoot vs Capacitive Load").

One method of improving capacitive load drive in the unity-gain configuration is to insert a 10Ω to 20Ω resistor inside the feedback loop, as shown in Figure 4. This reduces ringing with large capacitive loads while maintaining DC accuracy.

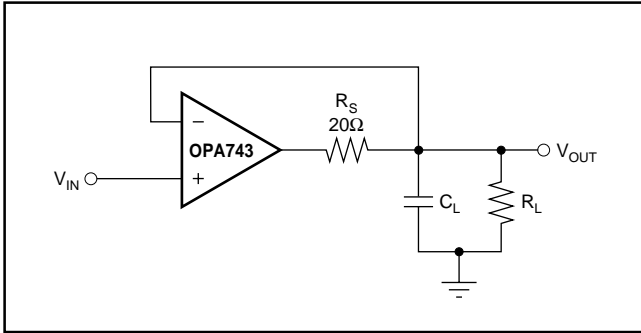

FIGURE 4. Series Resistor in Unity-Gain Buffer Configuration Improves Capacitive Load Drive.

APPLICATION CIRCUITS

The OPA743 series op amps are optimized for driving medium-speed sampling data converters. The OPA743 op amps buffer the converter's input capacitance and resulting charge injection while providing signal gain.

Figure 5 shows the OPA743 in a dual supply buffered reference configuration for the DAC7644.

REFERENCE BUFFER FOR LCD SOURCE DRIVERS

In modern high resolution TFT LCD displays, gamma correction must be performed to correct for nonlinearities in the glass transmission characteristics of the LCD panel. The typical LCD source driver for 64 Bits of Grayscale uses internal DAC to convert the 6-Bit data into analog voltages applied to the LCD. These DAC typically require external voltage references for proper operation. Normally these external reference voltages are generated using a simple resistive ladder, like the one shown in Figure 6.

Typical laptop or desktop LCD panels require 6 to 8 of the source driver circuits in parallel to drive all columns of the panel. Although the resistive load of one internal string DAC is only around 10kΩ, 6 to 8 in parallel represent a very substantial load. The power supply used for the LCD source drivers for laptops is typically in the order of 10V. To maximize the dynamic range of the DAC, rail-to-rail output performance is required for the upper and lower buffer. The OPA743's ability to operate on 12V supplies, to drive heavy resistive loads (as low as 1kΩ), and to swing to within 325mV of the supply rails, makes it very well suited as a buffer for the reference voltage inputs of LCD source drivers.

During conversion, the DAC's internal switches create current glitches on the output of the reference buffer. The capacitor C_L (typically 100nF) functions as a charge reservoir that provides/absorbs most of the glitch energy. The series resistor R_S isolates the outputs of the OPA743 from the heavy capacitive load and helps to improve settling time.

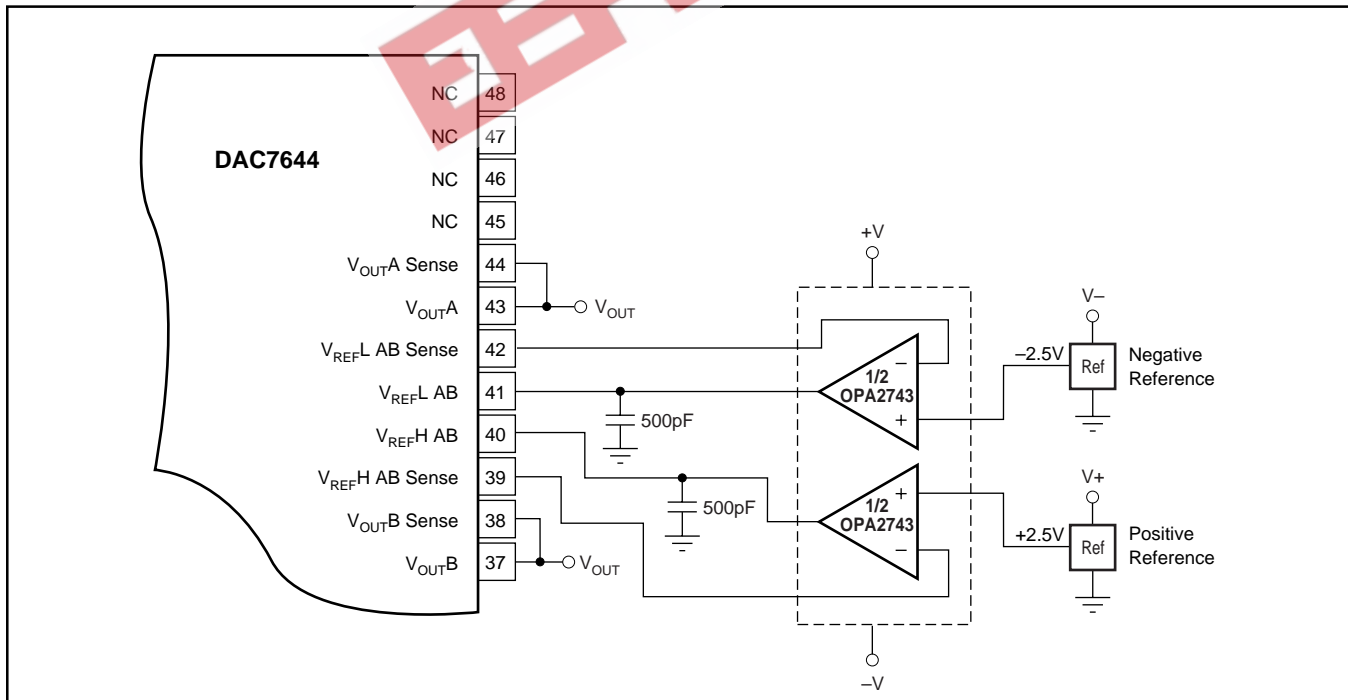

FIGURE 5. OPA743 as Dual Supply Configuration-Buffered References for the DAC7644.

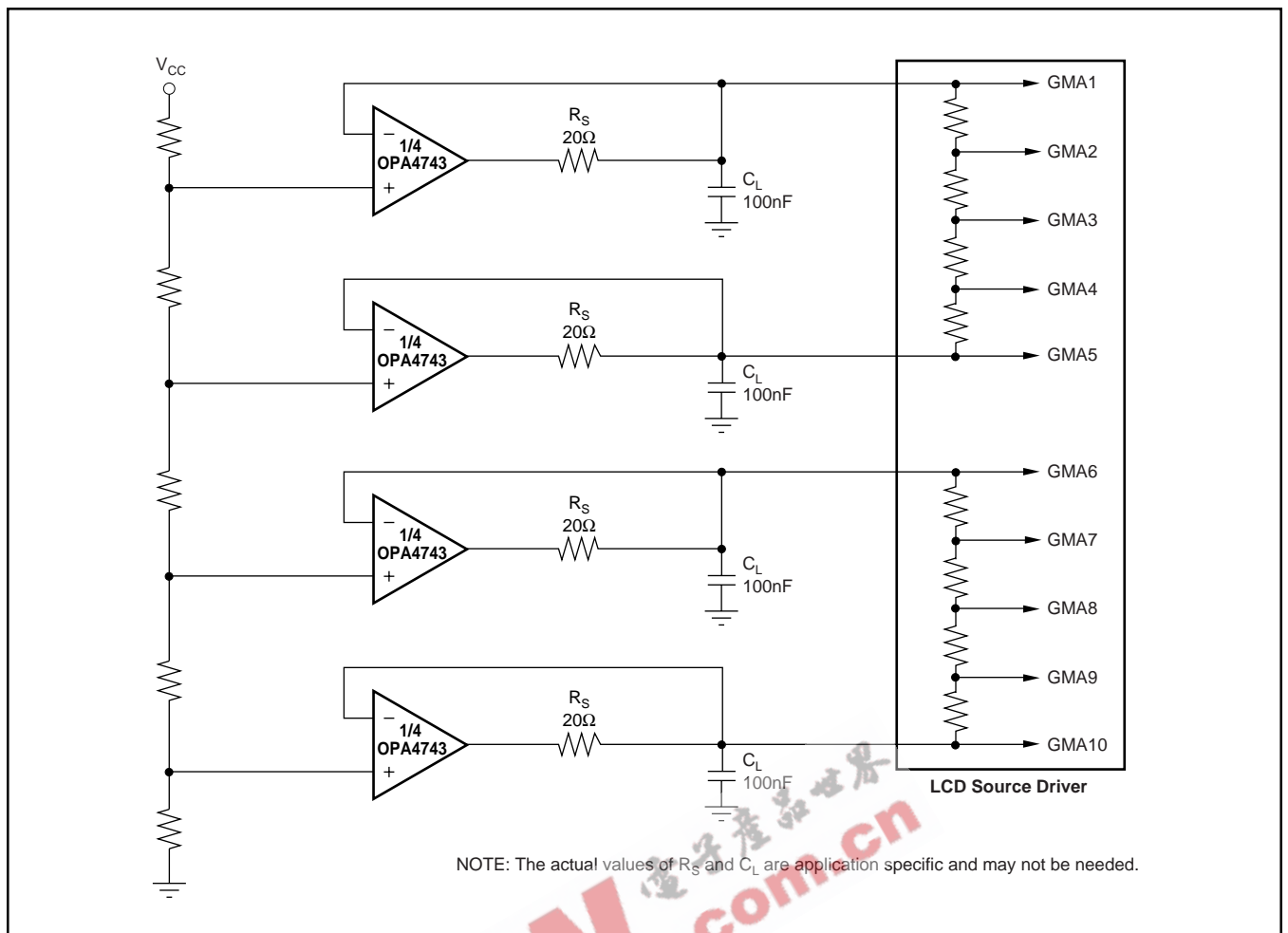

FIGURE 6. OPA743 Configured as a Reference Buffer for an LCD Display.

PACKAGING INFORMATION

Orderable Device	Status ⁽¹⁾	Package Type	Package Drawing	Pins	Package Qty	Eco Plan ⁽²⁾	Lead/Ball Finish	MSL Peak Temp ⁽³⁾
OPA2743EA/250	ACTIVE	MSOP	DGK	8	250	None	CU NIPDAU	Level-3-220C-168 HR
OPA2743EA/2K5	ACTIVE	MSOP	DGK	8	2500	None	CU NIPDAU	Level-3-220C-168 HR
OPA2743PA	ACTIVE	PDIP	P	8	50	Pb-Free (RoHS)	CU SNPB	Level-NC-NC-NC
OPA2743UA	ACTIVE	SOIC	D	8	100	None	CU NIPDAU	Level-3-220C-168 HR
OPA2743UA/2K5	ACTIVE	SOIC	D	8	2500	None	CU NIPDAU	Level-3-220C-168 HR
OPA4743EA/250	ACTIVE	TSSOP	PW	14	250	None	CU NIPDAU	Level-3-220C-168 HR
OPA4743EA/250G4	ACTIVE	TSSOP	PW	14	250	Green (RoHS & no Sb/Br)	CU NIPDAU	Level-2-260C-1 YEAR
OPA4743EA/2K5	ACTIVE	TSSOP	PW	14	2500	None	CU NIPDAU	Level-3-220C-168 HR
OPA4743UA	ACTIVE	SOIC	D	14	58	None	CU SNPB	Level-3-220C-168 HR
OPA4743UA/2K5	ACTIVE	SOIC	D	14	2500	None	CU SNPB	Level-3-220C-168 HR
OPA743NA/250	ACTIVE	SOT-23	DBV	5	250	None	CU NIPDAU	Level-3-220C-168 HR
OPA743NA/3K	ACTIVE	SOT-23	DBV	5	3000	None	CU NIPDAU	Level-3-220C-168 HR
OPA743NA/3KG4	PREVIEW	SOT-23	DBV	5	3000	None	Call TI	Call TI
OPA743PA	ACTIVE	PDIP	P	8	50	Pb-Free (RoHS)	CU SNPB	Level-NC-NC-NC
OPA743UA	ACTIVE	SOIC	D	8	100	None	CU NIPDAU	Level-1-235C-UNLIM
OPA743UA/2K5	ACTIVE	SOIC	D	8	2500	None	CU	Level-1-235C-UNLIM

⁽¹⁾ The marketing status values are defined as follows:

ACTIVE: Product device recommended for new designs.

LIFEBUY: TI has announced that the device will be discontinued, and a lifetime-buy period is in effect.

NRND: Not recommended for new designs. Device is in production to support existing customers, but TI does not recommend using this part in a new design.

PREVIEW: Device has been announced but is not in production. Samples may or may not be available.

OBSELETE: TI has discontinued the production of the device.

⁽²⁾ Eco Plan - May not be currently available - please check <http://www.ti.com/productcontent> for the latest availability information and additional product content details.

None: Not yet available Lead (Pb-Free).

Pb-Free (RoHS): TI's terms "Lead-Free" or "Pb-Free" mean semiconductor products that are compatible with the current RoHS requirements for all 6 substances, including the requirement that lead not exceed 0.1% by weight in homogeneous materials. Where designed to be soldered at high temperatures, TI Pb-Free products are suitable for use in specified lead-free processes.

Green (RoHS & no Sb/Br): TI defines "Green" to mean "Pb-Free" and in addition, uses package materials that do not contain halogens, including bromine (Br) or antimony (Sb) above 0.1% of total product weight.

⁽³⁾ MSL, Peak Temp. -- The Moisture Sensitivity Level rating according to the JEDEC industry standard classifications, and peak solder temperature.

Important Information and Disclaimer:The information provided on this page represents TI's knowledge and belief as of the date that it is provided. TI bases its knowledge and belief on information provided by third parties, and makes no representation or warranty as to the accuracy of such information. Efforts are underway to better integrate information from third parties. TI has taken and continues to take reasonable steps to provide representative and accurate information but may not have conducted destructive testing or chemical analysis on incoming materials and chemicals. TI and TI suppliers consider certain information to be proprietary, and thus CAS numbers and other limited information may not be available for release.

In no event shall TI's liability arising out of such information exceed the total purchase price of the TI part(s) at issue in this document sold by TI to Customer on an annual basis.

IMPORTANT NOTICE

Texas Instruments Incorporated and its subsidiaries (TI) reserve the right to make corrections, modifications, enhancements, improvements, and other changes to its products and services at any time and to discontinue any product or service without notice. Customers should obtain the latest relevant information before placing orders and should verify that such information is current and complete. All products are sold subject to TI's terms and conditions of sale supplied at the time of order acknowledgment.

TI warrants performance of its hardware products to the specifications applicable at the time of sale in accordance with TI's standard warranty. Testing and other quality control techniques are used to the extent TI deems necessary to support this warranty. Except where mandated by government requirements, testing of all parameters of each product is not necessarily performed.

TI assumes no liability for applications assistance or customer product design. Customers are responsible for their products and applications using TI components. To minimize the risks associated with customer products and applications, customers should provide adequate design and operating safeguards.

TI does not warrant or represent that any license, either express or implied, is granted under any TI patent right, copyright, mask work right, or other TI intellectual property right relating to any combination, machine, or process in which TI products or services are used. Information published by TI regarding third-party products or services does not constitute a license from TI to use such products or services or a warranty or endorsement thereof. Use of such information may require a license from a third party under the patents or other intellectual property of the third party, or a license from TI under the patents or other intellectual property of TI.

Reproduction of information in TI data books or data sheets is permissible only if reproduction is without alteration and is accompanied by all associated warranties, conditions, limitations, and notices. Reproduction of this information with alteration is an unfair and deceptive business practice. TI is not responsible or liable for such altered documentation.

Resale of TI products or services with statements different from or beyond the parameters stated by TI for that product or service voids all express and any implied warranties for the associated TI product or service and is an unfair and deceptive business practice. TI is not responsible or liable for any such statements.

Following are URLs where you can obtain information on other Texas Instruments products and application solutions:

Products		Applications	
Amplifiers	amplifier.ti.com	Audio	www.ti.com/audio
Data Converters	dataconverter.ti.com	Automotive	www.ti.com/automotive
DSP	dsp.ti.com	Broadband	www.ti.com/broadband
Interface	interface.ti.com	Digital Control	www.ti.com/digitalcontrol
Logic	logic.ti.com	Military	www.ti.com/military
Power Mgmt	power.ti.com	Optical Networking	www.ti.com/opticalnetwork
Microcontrollers	microcontroller.ti.com	Security	www.ti.com/security
		Telephony	www.ti.com/telephony
		Video & Imaging	www.ti.com/video
		Wireless	www.ti.com/wireless

Mailing Address: Texas Instruments
Post Office Box 655303 Dallas, Texas 75265