

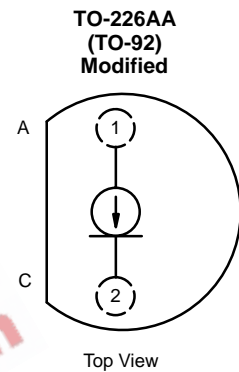

## Current Regulator Diodes

|             |             |             |             |
|-------------|-------------|-------------|-------------|
| <b>J500</b> | <b>J503</b> | <b>J506</b> | <b>J509</b> |
| <b>J501</b> | <b>J504</b> | <b>J507</b> | <b>J510</b> |
| <b>J502</b> | <b>J505</b> | <b>J508</b> | <b>J511</b> |

| PRODUCT SUMMARY |                |              |             |                |              |
|-----------------|----------------|--------------|-------------|----------------|--------------|
| Part Number     | Typ $I_F$ (mA) | $P_{OV}$ (V) | Part Number | Typ $I_F$ (mA) | $P_{OV}$ (V) |
| J500            | 0.24           | 50           | J506        | 1.40           | 50           |
| J501            | 0.33           | 50           | J507        | 1.80           | 50           |
| J502            | 0.43           | 50           | J508        | 2.40           | 50           |
| J503            | 0.56           | 50           | J509        | 3.00           | 50           |
| J504            | 0.75           | 50           | J510        | 3.60           | 50           |
| J505            | 1.00           | 50           | J511        | 4.70           | 50           |



### FEATURES

- Two-Lead Plastic Package
- Guaranteed  $\pm 20\%$  Tolerance
- Operation from 1 V (J500–J503) to 50 V
- Excellent Temperature Stability

### BENEFITS

- Simple Series Circuitry, No Separate Voltage Source
- Tight Guaranteed Circuit Performance
- Excellent Performance in Low-Voltage/Battery Circuits and High-Voltage Spike Protection
- High Circuit Stability vs. Temperature

### APPLICATIONS

- Constant-Current Supply
- Current-Limiting
- Timing Circuits

### DESCRIPTION

The J500 series is a family of  $\pm 20\%$  range current regulators designed for demanding applications in test equipment and instrumentation. These devices utilize the JFET techniques to produce a single two-leaded device which is extremely simple to operate.

With nominal current ranges from 0.24 mA to 4.7 mA, the J500 series will meet a wide array of design requirements.

The low-cost TO-226A package ensures a cost-effective design solution.

### SCHEMATIC DIAGRAM

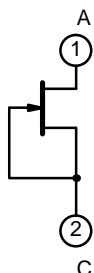

### APPLICATIONS

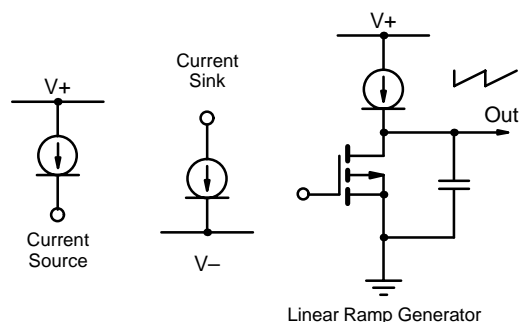

For applications information see AN103.



### ABSOLUTE MAXIMUM RATINGS

|                              |              |                                      |        |
|------------------------------|--------------|--------------------------------------|--------|
| Peak Operating Voltage ..... | 50 V         | Power Dissipation <sup>a</sup> ..... | 350 mW |
| Reverse Current .....        | 50 mA        | Notes:                               |        |
| Storage Temperature .....    | -55 to 150°C | a. Derate 2.8 mW/°C above 25°C       |        |

| SPECIFICATIONS (T <sub>A</sub> = 25°C UNLESS OTHERWISE NOTED) |                 |  |        |                  |     |      |
|---|-----------------|--|--------|------------------|-----|------|
| Parameter   | Symbol          | Test Conditions                          | Limits |                  |     | Unit |
|   |                 |  | Min    | Typ <sup>a</sup> | Max |      |
| Peak Operating Voltage <sup>b</sup>                           | P <sub>OV</sub> | I <sub>F</sub> = 1.1 I <sub>F(max)</sub> | 50     | 95               |     | V    |
| Reverse Voltage   | V <sub>R</sub>  | I <sub>R</sub> = 1 mA                    |        | 0.8              |     |      |
| Capacitance   | C <sub>F</sub>  | V <sub>F</sub> = 25 V, f = 1 MHz         |        | 2.2              |     | pF   |

| Part Number | Regulator Current <sup>c</sup><br>(I <sub>F</sub> ) |      |       | Dynamic Impedance <sup>d</sup><br>(Z <sub>d</sub> ) |                  | Knee Impedance<br>(Z <sub>k</sub> ) | Limiting Voltage <sup>e</sup> (V <sub>L</sub> ) |                  | Temperature Coefficient<br>(θ <sub>J</sub> )          |
|-------------|---|------|-------|---|------------------|-------------------------------------|---|------------------|---|
|             | V <sub>F</sub> = 25 V                               |      |       | V <sub>F</sub> = 25 V                               |                  | V <sub>F</sub> = 6 V                | I <sub>F</sub> = 0.8 I <sub>F(min)</sub>        |                  | V <sub>F</sub> = 25 V<br>0°C ≤ T <sub>A</sub> ≤ 100°C |
|             | Min   | Nom  | Max   | Min   | Typ <sup>a</sup> | Typ <sup>a</sup>                    | Max   | Typ <sup>a</sup> | %/°C  |
| J500        | 0.192   | 0.24 | 0.288 | 4.00  | 15               | 2.50                                | 1.2   | 0.4              | 0.95  |
| J501        | 0.264   | 0.33 | 0.396 | 2.20  | 10               | 1.60                                | 1.3   | 0.5              | 0.81  |
| J502        | 0.344   | 0.43 | 0.516 | 1.50  | 7                | 1.10                                | 1.5   | 0.6              | 0.70  |
| J503        | 0.448   | 0.56 | 0.672 | 1.20  | 5                | 0.80                                | 1.7   | 0.7              | 0.58  |
| J504        | 0.600   | 0.75 | 0.900 | 0.80  | 3.5              | 0.55                                | 1.9   | 0.8              | 0.46  |
| J505        | 0.800   | 1.00 | 1.200 | 0.50  | 2                | 0.40                                | 2.1   | 0.9              | 0.33  |
| J506        | 1.120   | 1.40 | 1.680 | 0.33  | 1.5              | 0.25                                | 2.5   | 1.1              | 0.19  |
| J507        | 1.440   | 1.80 | 2.160 | 0.20  | 1                | 0.19                                | 2.8   | 1.3              | 0.08  |
| J508        | 1.900   | 2.40 | 2.900 | 0.20  | 0.7              | 0.13                                | 3.1   | 1.5              | -0.05   |
| J509        | 2.400   | 3.00 | 3.600 | 0.15  | 0.5              | 0.09                                | 3.5   | 1.7              | -0.14   |
| J510        | 2.900   | 3.60 | 4.300 | 0.15  | 0.4              | 0.07                                | 3.9   | 1.9              | -0.22   |
| J511        | 3.800   | 4.70 | 5.600 | 0.12  | 0.3              | 0.05                                | 4.2   | 2.1              | -0.34   |

- Notes:
- Typical values are for DESIGN AID ONLY, not guaranteed nor subject to production testing.
  - Max V<sub>F</sub> where I<sub>F</sub> = 1.1 I<sub>F(max)</sub> is guaranteed.
  - Pulse test—steady state currents may vary.
  - Pulse test—steady state impedances may vary.
  - Min V<sub>F</sub> required to insure I<sub>F</sub> = 0.8 I<sub>F(min)</sub>.

NCL



**TYPICAL CHARACTERISTICS ( $T_A = 25^\circ\text{C}$  UNLESS OTHERWISE NOTED)**

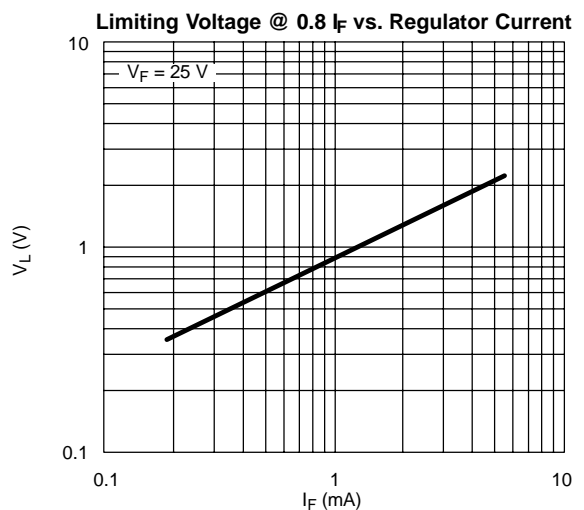
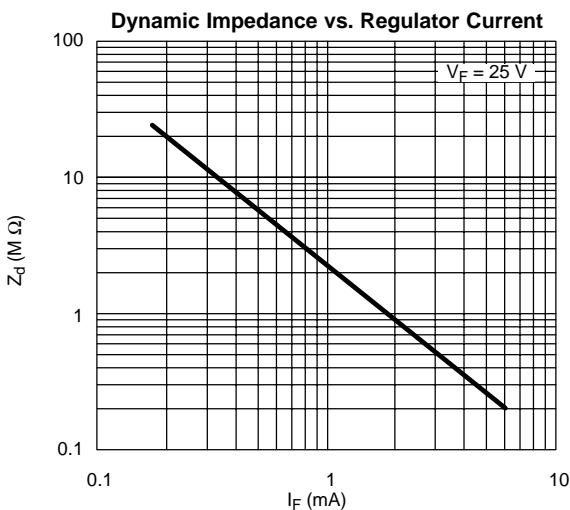
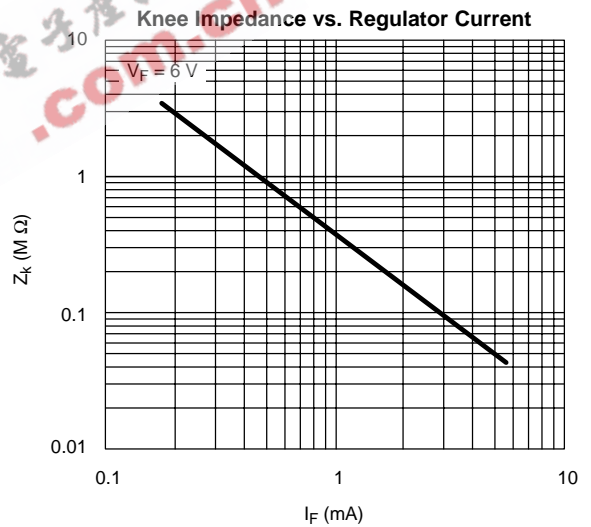
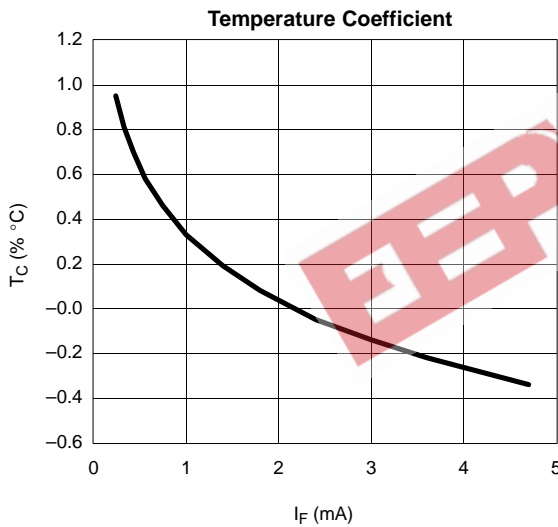
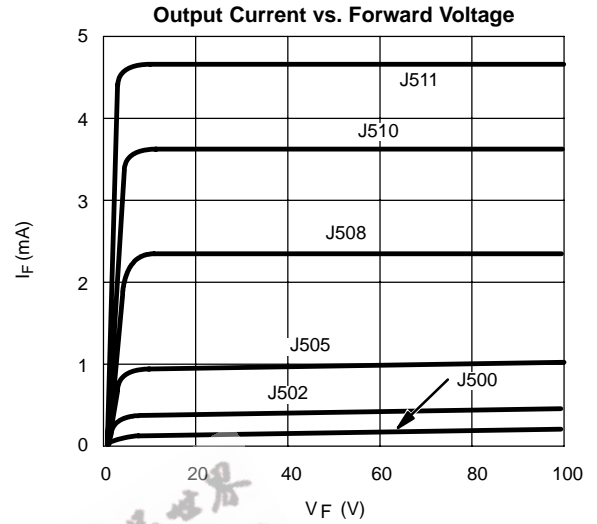
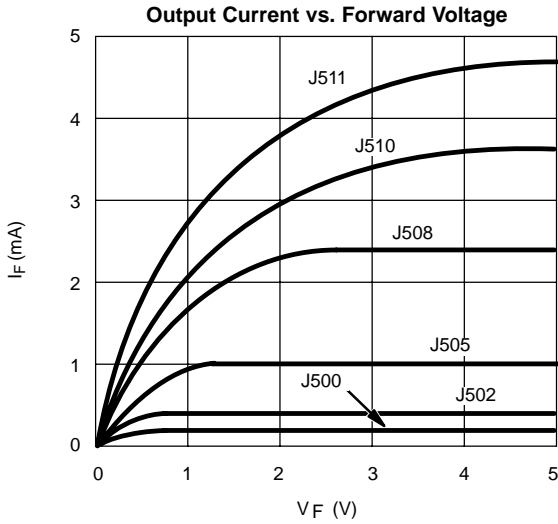

**TYPICAL CHARACTERISTICS ( $T_A = 25^\circ\text{C}$  UNLESS OTHERWISE NOTED)**

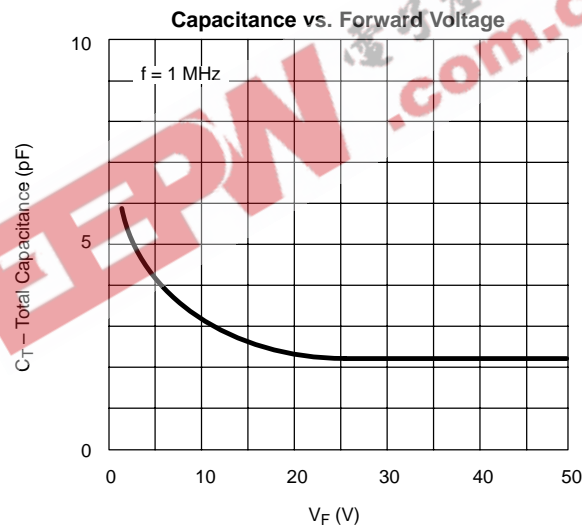
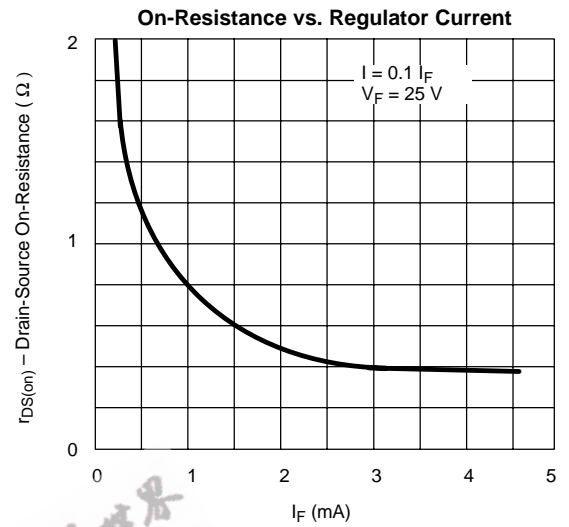
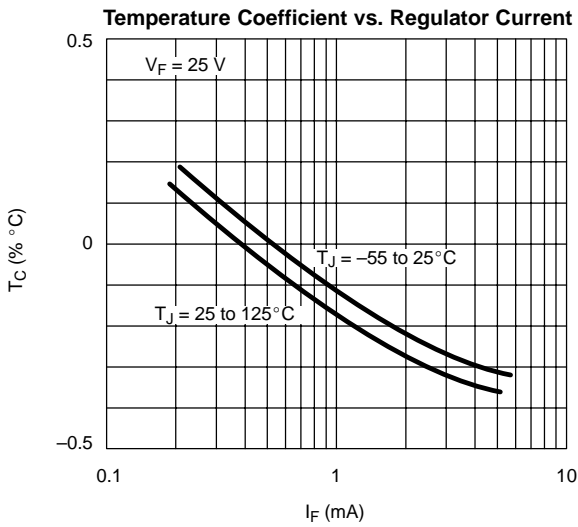

**CURRENT REGULATOR DIODE V-1 CHARACTERISTIC**

