

K3630 • K3631

These Photocouplers consist of two Gallium Arsenide Infrared Emitting Diodes and a Silicon NPN Phototransistor in a 6-pin package.

FEATURES

- Switching Time - Type 3μs
- Collector-Emitter Voltage : Min.35V
- Current Transfer Ratio : Typ.10% (at IF= ± 10mA, VCE=10V)
- Electrical Isolation Voltage : AC2500Vrms
- Without Base Connection - K3630
- With Base Connection - K3631
- UL Recognized File No. E107486

APPLICATIONS

- Interface between two circuits of different potential
- AC signal input
- Telephone set & line interface
- I/O compatible with integrated circuits

DIMENSION

(Unit : mm)

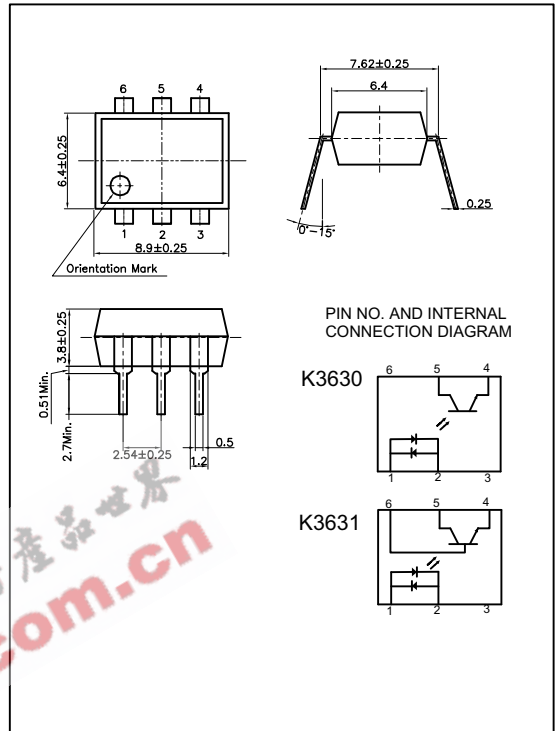

MAXIMUM RATINGS

(Ta=25)

Parameter		Symbol	Rating	Unit
Input	Forward Current	IF	± 60	mA
	Peak Forward Current ^{*1}	IFP	± 1	A
	Power Dissipation	PD	70	mW
Output	Collector-Emitter Breakdown Voltage	BVCEO	35	V
	Emitter-Collector Breakdown Voltage	BVECO	6	V
	Collector-Base Breakdown Voltage ^{**}	BVCBO	70	V
	Emitter-Base Breakdown Voltage ^{**}	BVEBO	6	V
	Collector Current	IC	50	mA
	Collector Power Dissipation	PC	150	mW
Input to Output Isolation Voltage ^{*2}		Viso	AC2500	Vrms
Storage Temperature		Tstg	-55~+125	
Operating Temperature		Topr	-30~+100	
Lead Soldering Temperature ^{*3}		Tsol	260	
Total Power Dissipation		Ptot	200	mW

^{**} Except for K3630

^{*1} Input current with 100μs pulse width, 1% duty cycle

^{*2} Measured at RH=40-60% for 1min

^{*3} 1/16 inch form case for 10sec

K3630 • K3631

ELECTRO-OPTICAL CHARACTERISTICS

(Ta=25°C, unless otherwise noted)

Parameter		Symbol	Condition	Min.	Typ.	Max.	Unit.
Input	Forward Voltage	V _F	I _F =10mA	-	1.15	1.30	V
	Capacitance	C _T	V=0, f=1MHz	-	30	-	pF
Output	Collector-Emitter Breakdown Voltage	BV _{CEO}	I _C =1mA	35	-	-	V
	Emitter-Collector Breakdown Voltage	BV _{ECO}	I _E =0.1mA	6	-	-	V
	Collector-Base Breakdown Voltage **	BV _{CBO}	I _C =0.1mA	70	-	-	V
	Emitter-Base Breakdown Voltage **	BV _{EBO}	I _E =0.1mA	6	-	-	V
	Collector Dark Current	I _{CEO}	I _F =0, V _{CE} =10V	-	-	100	nA
	Capacitance	C _{CE}	V _{CE} =0, f=1MHz	-	10	-	pF
Coupled	Current Transfer Ratio *4	CTR	I _F =10mA, V _{CE} =10V	50	-	200	%
	Collector-Emitter Saturation Voltage	V _{CE(SAT)}	I _F =10mA, I _C =0.5mA	-	-	0.4	V
	Input-Output Capacitance	C _{IO}	V=0, f=1MHz	-	2	-	pF
	Input-Output Isolation Resistance	R _{IO}	RH=40~60%, V=500V	-	10 ¹¹	-	
	Rise Time	t _r	V _{CE} =5V, R _L =100Ω	-	3	-	μs
	Fall Time	t _f	I _C =2mA	-	3	-	μs
CTR Symmetry		CTR1/CTR2		0.33	-	3.0	

** Except for K3630

*4. CTR=(I_C/I_F) X 100 (%)

K3630 • K3631

Forward Current vs. Ambient Temperature

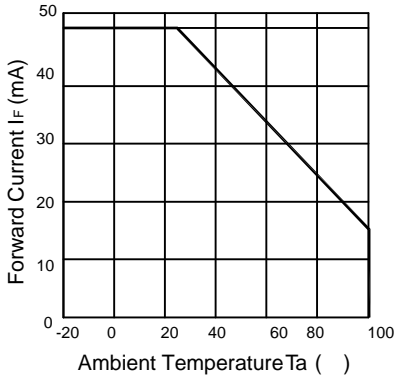

Collector Power Dissipation vs. Ambient Temperature

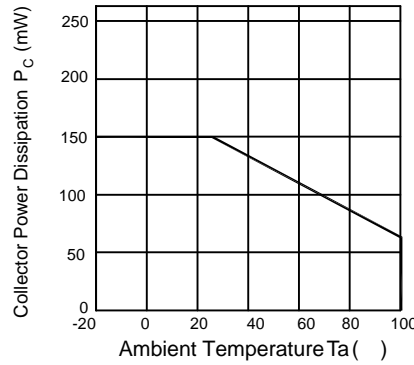

Forward Current vs. Forward Voltage

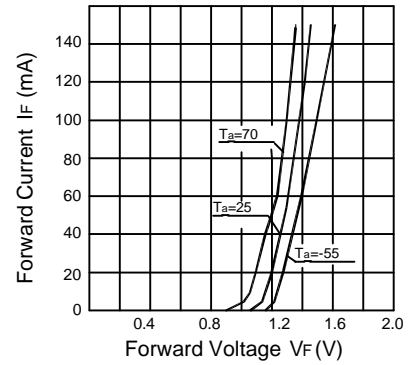

Collector Current vs. Collector-Emitter Voltage

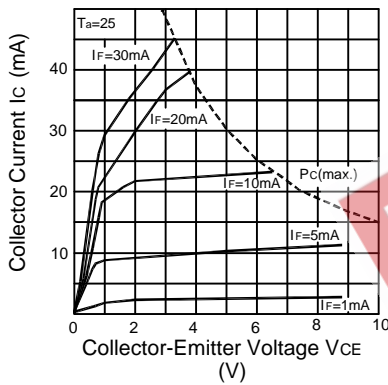

Dark Current vs. Ambient Temperature

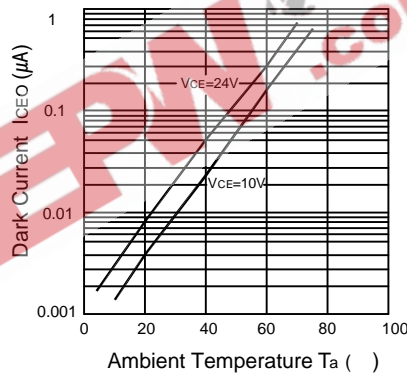

Collector Current vs. Ambient Temperature

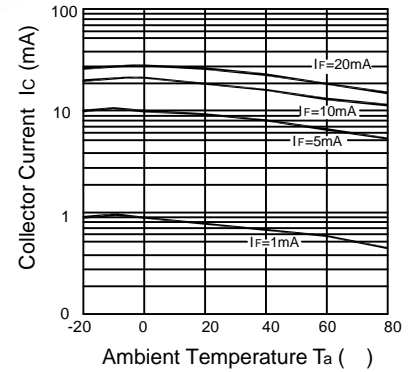

Response Time vs. Load Resistance

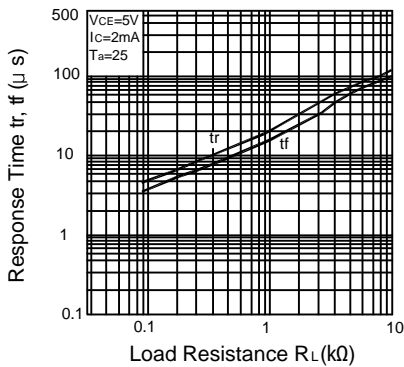

Collector Current vs. Forward Current

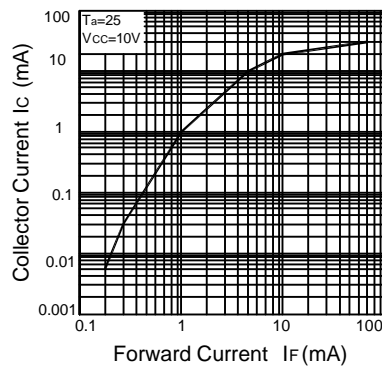

Switching Time Test Circuit

